

ATTACHMENT 1: MD-80 THREE-VIEW DRAWING

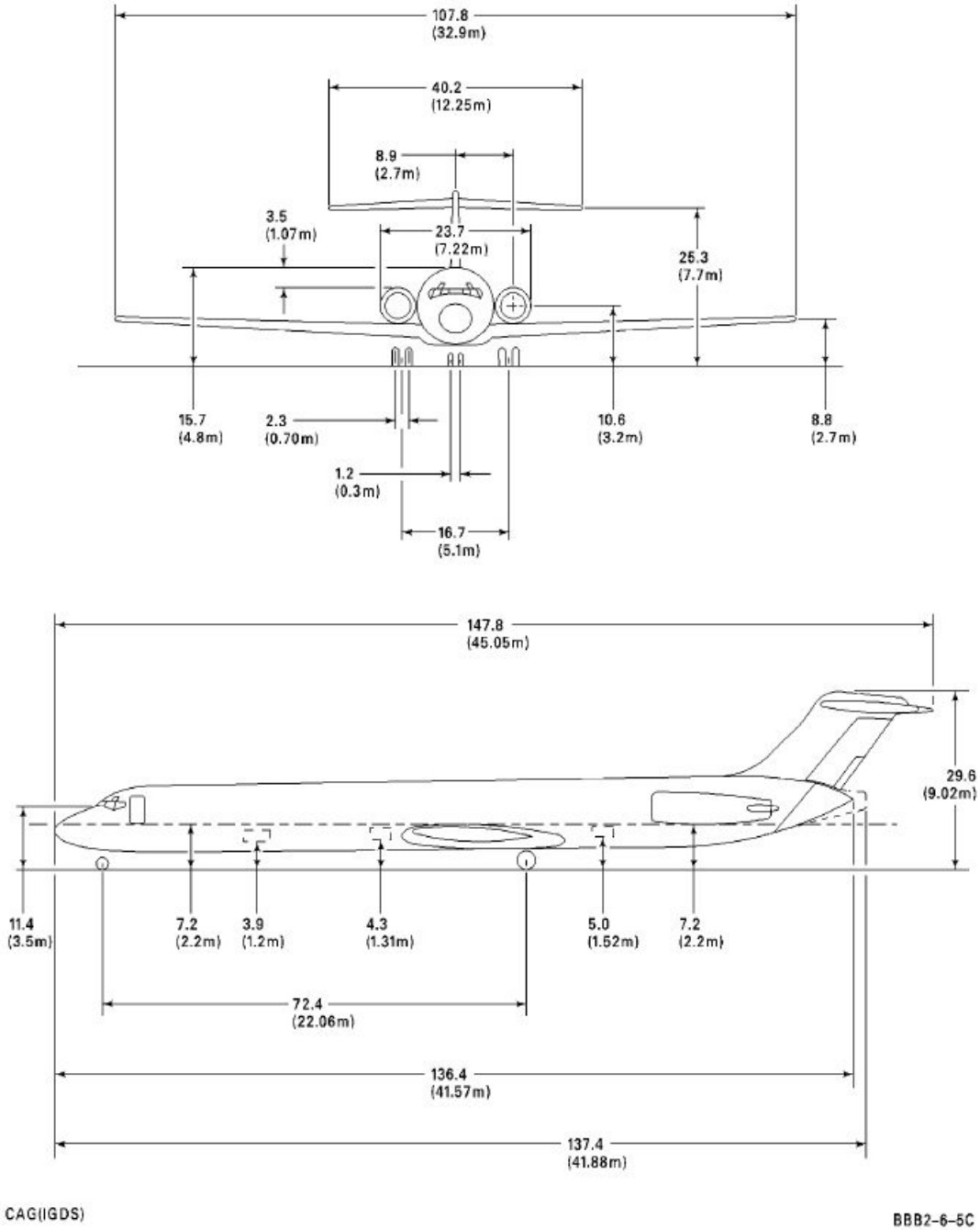

MD-80 AIRCRAFT MAINTENANCE MANUAL



Aircraft Dimensions
Figure 1/06-10-00-990-801 (Sheet 1 of 2)

Figure A1.1: MD-80 front- and side-view drawings.



MD-80
AIRCRAFT MAINTENANCE MANUAL

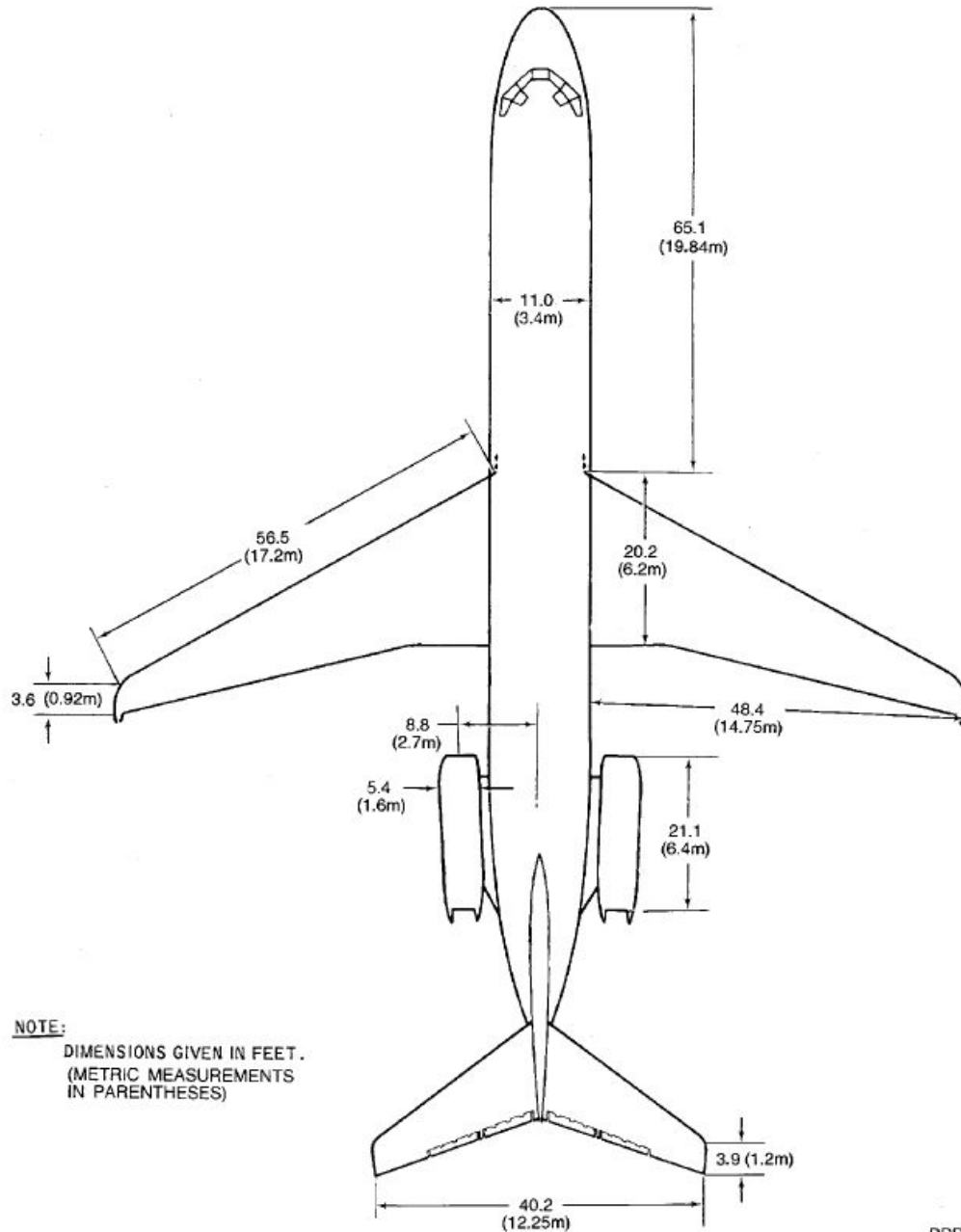

BBB2-6-6B

Aircraft Dimensions
Figure 1/06-10-00-990-801 (Sheet 2 of 2)

Figure A1.2: MD-80 top-view drawing.

ATTACHMENT 2: MIAMI INTERNATIONAL AIRPORT (MIA)

AIRPORT DIAGRAM

AL-257 (FAA)

MIAMI INTL (MIA)
MIAMI, FLORIDA

SE-3, 20 APR 2023 to 18 MAY 2023

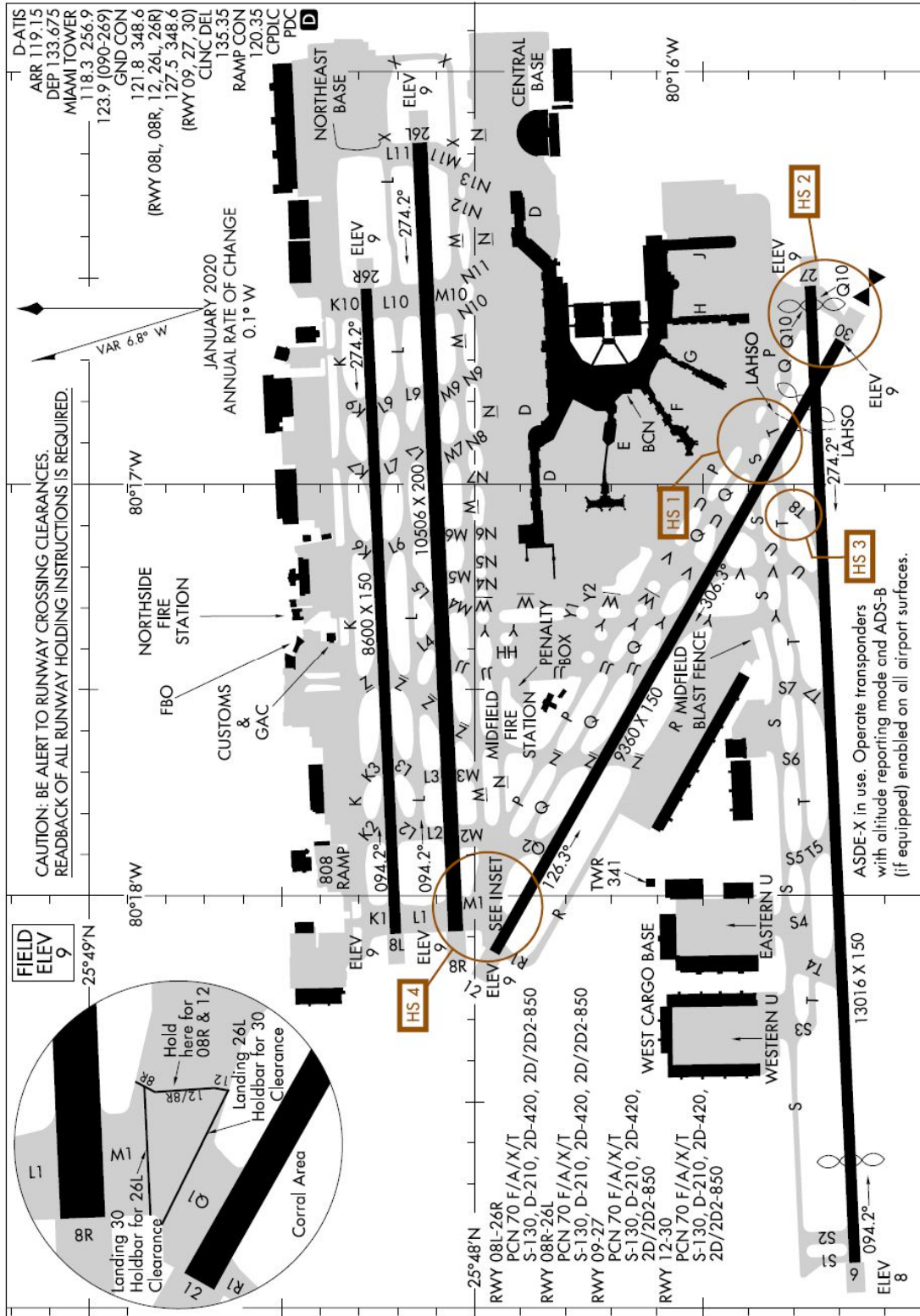

SE-3, 20 APR 2023 to 18 MAY 2023

AIRPORT DIAGRAM

MIAMI, FLORIDA
MIAMI INTL (MIA)

Figure A2.1: Miami International Airport (MIA) diagram. HI1064 landed on runway 9.



Figure A2.2: Miami International Airport (MIA) image (Google Earth). North is toward the left side of the page; East is toward the top of the page. The approach end of runway 9 is in the lower right corner.

ATTACHMENT 3: "SW GATE AOA TRK PTZ SITE 11" CAMERA
IMAGE SEQUENCE

6/21/2022
5:37:39 PM

S.W. GATE AOA TRK PTZ Site11-VR1-ETH1-C



00092

6/21/2022
5:37:40 PM

S.W. GATE AOA TRK PTZ Site11-VR1-ETH1-C



00093

6/21/2022
5:37:40 PM

S.W. GATE AOA TRK PTZ Site11-VR1-ETH1-C



00094

6/21/2022
5:37:40 PM

S.W. GATE AOA TRK PTZ Site11-VR1-ETH1-C



00095

6/21/2022
5:37:40 PM

S.W. GATE AOA TRK PTZ Site11-VR1-ETH1-C



00096

6/21/2022
5:37:40 PM

S.W. GATE AOA TRK PTZ Site11-VR1-ETH1-C



00097

6/21/2022
5:37:40 PM

S.W. GATE AOA TRK PTZ Site11-VR1-ETH1-C



00098

6/21/2022
5:37:40 PM

S.W. GATE AOA TRK PTZ Site11-VR1-ETH1-C



00099

6/21/2022
5:37:40 PM

S.W. GATE AOA TRK PTZ Site11-VR1-ETH1-C



00100

6/21/2022
5:37:40 PM

S.W. GATE AOA TRK PTZ Site11-VR1-ETH1-C



00101

6/21/2022
5:37:41 PM

S.W. GATE AOA TRK PTZ Site11-VR1-ETH1-C



00102

6/21/2022
5:37:41 PM

S.W. GATE AOA TRK PTZ Site11-VR1-ETH1-C



00103

6/21/2022
5:37:41 PM

S.W. GATE AOA TRK PTZ Site11-VR1-ETH1-C



6/21/2022
5:37:41 PM

S.W. GATE AOA TRK PTZ Site11-VR1-ETH1-C



6/21/2022
5:37:41 PM

S.W. GATE AOA TRK PTZ Site11-VR1-ETH1-C



00106

6/21/2022
5:37:41 PM

S.W. GATE AOA TRK PTZ Site11-VR1-ETH1-C



00107

6/21/2022
5:37:41 PM

S.W. GATE AOA TRK PTZ Site11-VR1-ETH1-C



00108

6/21/2022
5:37:42 PM

S.W. GATE AOA TRK PTZ Site11-VR1-ETH1-C



00109

6/21/2022
5:37:42 PM

S.W. GATE AOA TRK PTZ Site11-VR1-ETH1-C



00110

6/21/2022
5:37:42 PM

S.W. GATE AOA TRK PTZ Site11-VR1-ETH1-C



00111

6/21/2022
5:37:42 PM

S.W. GATE AOA TRK PTZ Site11-VR1-ETH1-C



00112

6/21/2022
5:37:42 PM

S.W. GATE AOA TRK PTZ Site11-VR1-ETH1-C



00113

6/21/2022
5:37:42 PM

S.W. GATE AOA TRK PTZ Site11-VR1-ETH1-C



00114

6/21/2022
5:37:42 PM

S.W. GATE AOA TRK PTZ Site11-VR1-ETH1-C



00115

6/21/2022
5:37:42 PM

S.W. GATE AOA TRK PTZ Site11-VR1-ETH1-C



00116

6/21/2022
5:37:48 PM

S.W. GATE AOA TRK PTZ Site11-VR1-ETH1-C



00117

6/21/2022
5:37:43 PM

S.W. GATE AOA TRK PTZ Site11-VR1-ETH1-C



00118

6/21/2022
5:37:43 PM

S.W. GATE AOA TRK PTZ Site11-VR1-ETH1-C



00119

6/21/2022
5:37:43 PM

S.W. GATE AOA TRK PTZ Site11-VR1-ETH1-C



00120

6/21/2022
5:37:43 PM

S.W. GATE AOA TRK PTZ Site11-VR1-ETH1-C



00121

6/21/2022
5:37:43 PM

S.W. GATE AOA TRK PTZ Site11-VR1-ETH1-C



00122

6/21/2022
5:37:43 PM

S.W. GATE AOA TRK PTZ Site11-VR1-ETH1-C



00123

6/21/2022
5:37:43 PM

S.W. GATE AOA TRK PTZ Site11-VR1-ETH1-C



00124

6/21/2022
5:37:43 PM

S.W. GATE AOA TRK PTZ Site11-VR1-ETH1-C



00125

6/21/2022
5:37:44 PM

S.W. GATE AOA TRK PTZ Site11-VR1-ETH1-C



00126

6/21/2022
5:37:44 PM

S.W. GATE AOA TRK PTZ Site11-VR1-ETH1-C



00127

6/21/2022
5:37:44 PM

S.W. GATE AOA TRK PTZ Site11-VR1-ETH1-C



6/21/2022
5:37:44 PM

S.W. GATE AOA TRK PTZ Site11-VR1-ETH1-C



6/21/2022
5:37:44 PM

S.W. GATE AOA TRK PTZ Site11-VR1-ETH1-C



00130

6/21/2022
5:37:44 PM

S.W. GATE AOA TRK PTZ Site11-VR1-ETH1-C



00131

6/21/2022
5:37:44 PM

S.W. GATE AOA TRK PTZ Site11-VR1-ETH1-C



00132

6/21/2022
5:37:44 PM

S.W. GATE AOA TRK PTZ Site11-VR1-ETH1-C



00133

6/21/2022
5:37:45 PM

S.W. GATE AOA TRK PTZ Site11-VR1-ETH1-C



00134

6/21/2022
5:37:45 PM

S.W. GATE AOA TRK PTZ Site11-VR1-ETH1-C



00135

6/21/2022
5:37:45 PM

S.W. GATE AOA TRK PTZ Site11-VR1-ETH1-C



6/21/2022
5:37:45 PM

S.W. GATE AOA TRK PTZ Site11-VR1-ETH1-C



6/21/2022
5:37:45 PM

S.W. GATE AOA TRK PTZ Site11-VR1-ETH1-C



00138

6/21/2022
5:37:45 PM

S.W. GATE AOA TRK PTZ Site11-VR1-ETH1-C



00139

6/21/2022
5:37:45 PM

S.W. GATE AOA TRK PTZ Site11-VR1-ETH1-C



00140

6/21/2022
5:37:45 PM

S.W. GATE AOA TRK PTZ Site11-VR1-ETH1-C



00141

6/21/2022
5:37:45 PM

S.W. GATE AOA TRK PTZ Site11-VR1-ETH1-C



6/21/2022
5:37:46 PM

S.W. GATE AOA TRK PTZ Site11-VR1-ETH1-C



6/21/2022
5:37:46 PM

S.W. GATE AOA TRK PTZ Site11-VR1-ETH1-C



00144

6/21/2022
5:37:46 PM

S.W. GATE AOA TRK PTZ Site11-VR1-ETH1-C



00145

6/21/2022
5:37:46 PM

S.W. GATE AOA TRK PTZ Site11-VR1-ETH1-C



00146

6/21/2022
5:37:46 PM

S.W. GATE AOA TRK PTZ Site11-VR1-ETH1-C



00147

6/21/2022
5:37:46 PM

S.W. GATE AOA TRK PTZ Site11-VR1-ETH1-C



00148

6/21/2022
5:37:46 PM

S.W. GATE AOA TRK PTZ Site11-VR1-ETH1-C



00149

6/21/2022
5:37:46 PM

S.W. GATE AOA TRK PTZ Site11-VR1-ETH1-C



6/21/2022
5:37:47 PM

S.W. GATE AOA TRK PTZ Site11-VR1-ETH1-C



6/21/2022
5:37:47 PM

S.W. GATE AOA TRK PTZ Site11-VR1-ETH1-C



00152

6/21/2022
5:37:47 PM

S.W. GATE AOA TRK PTZ Site11-VR1-ETH1-C



00153

6/21/2022
5:37:47 PM

S.W. GATE AOA TRK PTZ Site11-VR1-ETH1-C



00154

6/21/2022
5:37:47 PM

S.W. GATE AOA TRK PTZ Site11-VR1-ETH1-C



00155

6/21/2022
5:37:47 PM

S.W. GATE AOA TRK PTZ Site11-VR1-ETH1-C



00156

6/21/2022
5:37:47 PM

S.W. GATE AOA TRK PTZ Site11-VR1-ETH1-C



00157

6/21/2022
5:37:47 PM

S.W. GATE AOA TRK PTZ Site11-VR1-ETH1-C



00158

6/21/2022
5:37:47 PM

S.W. GATE AOA TRK PTZ Site11-VR1-ETH1-C



00159

6/21/2022
5:37:48 PM

S.W. GATE AOA TRK PTZ Site11-VR1-ETH1-C



00160

6/21/2022
5:37:48 PM

S.W. GATE AOA TRK PTZ Site11-VR1-ETH1-C



00161

6/21/2022
5:37:48 PM

S.W. GATE AOA TRK PTZ Site11-VR1-ETH1-C



00162

6/21/2022
5:37:48 PM

S.W. GATE AOA TRK PTZ Site11-VR1-ETH1-C



00163

6/21/2022
5:37:48 PM

S.W. GATE AOA TRK PTZ Site11-VR1-ETH1-C



00164

6/21/2022
5:37:48 PM

S.W. GATE AOA TRK PTZ Site11-VR1-ETH1-C



00165

6/21/2022
5:37:48 PM

S.W. GATE AOA TRK PTZ Site11-VR1-ETH1-C



00166

6/21/2022
5:37:48 PM

S.W. GATE AOA TRK PTZ Site11-VR1-ETH1-C



00167

6/21/2022
5:37:49 PM

S.W. GATE AOA TRK PTZ Site11-VR1-ETH1-C



00168

6/21/2022
5:37:49 PM

S.W. GATE AOA TRK PTZ Site11-VR1-ETH1-C



00169

6/21/2022
5:37:49 PM

S.W. GATE AOA TRK PTZ Site11-VR1-ETH1-C



00170

6/21/2022
5:37:49 PM

S.W. GATE AOA TRK PTZ Site11-VR1-ETH1-C



00171

6/21/2022
5:37:49 PM

S.W. GATE AOA TRK PTZ Site11-VR1-ETH1-C



00172

6/21/2022
5:37:49 PM

S.W. GATE AOA TRK PTZ Site11-VR1-ETH1-C



00173

6/21/2022
5:37:49 PM

S.W. GATE AOA TRK PTZ Site11-VR1-ETH1-C



00174

6/21/2022
5:37:49 PM

S.W. GATE AOA TRK PTZ Site11-VR1-ETH1-C



00175

6/21/2022
5:37:50 PM

S.W. GATE AOA TRK PTZ Site11-VR1-ETH1-C



00176

6/21/2022
5:37:50 PM

S.W. GATE AOA TRK PTZ Site11-VR1-ETH1-C



00177

6/21/2022
5:37:50 PM

S.W. GATE AOA TRK PTZ Site11-VR1-ETH1-C



6/21/2022
5:37:50 PM

S.W. GATE AOA TRK PTZ Site11-VR1-ETH1-C



6/21/2022
5:37:50 PM

S.W. GATE AOA TRK PTZ Site11-VR1-ETH1-C



6/21/2022
5:37:50 PM

S.W. GATE AOA TRK PTZ Site11-VR1-ETH1-C



6/21/2022
5:37:50 PM

S.W. GATE AOA TRK PTZ Site11-VR1-ETH1-C



6/21/2022
5:37:50 PM

S.W. GATE AOA TRK PTZ Site11-VR1-ETH1-C



6/21/2022
5:37:51 PM

S.W. GATE AOA TRK PTZ Site11-VR1-ETH1-C



00184

6/21/2022
5:37:51 PM

S.W. GATE AOA TRK PTZ Site11-VR1-ETH1-C



00185

6/21/2022
5:37:51 PM

S.W. GATE AOA TRK PTZ Site11-VR1-ETH1-C



6/21/2022
5:37:51 PM

S.W. GATE AOA TRK PTZ Site11-VR1-ETH1-C



6/21/2022
5:37:51 PM

S.W. GATE AOA TRK PTZ Site11-VR1-ETH1-C



6/21/2022
5:37:51 PM

S.W. GATE AOA TRK PTZ Site11-VR1-ETH1-C



6/21/2022
5:37:51 PM

S.W. GATE AOA TRK PTZ Site11-VR1-ETH1-C



00190

6/21/2022
5:37:51 PM

S.W. GATE AOA TRK PTZ Site11-VR1-ETH1-C



00191

6/21/2022
5:37:52 PM

S.W. GATE AOA TRK PTZ Site11-VR1-ETH1-C



00192

6/21/2022
5:37:52 PM

S.W. GATE AOA TRK PTZ Site11-VR1-ETH1-C



00193

6/21/2022
5:37:52 PM

S.W. GATE AOA TRK PTZ Site11-VR1-ETH1-C



6/21/2022
5:37:52 PM

S.W. GATE AOA TRK PTZ Site11-VR1-ETH1-C



6/21/2022
5:37:52 PM

S.W. GATE AOA TRK PTZ Site11-VR1-ETH1-C



00196

6/21/2022
5:37:52 PM

S.W. GATE AOA TRK PTZ Site11-VR1-ETH1-C



00197

6/21/2022
5:37:52 PM

S.W. GATE AOA TRK PTZ Site11-VR1-ETH1-C



00198

6/21/2022
5:37:52 PM

S.W. GATE AOA TRK PTZ Site11-VR1-ETH1-C



00199

6/21/2022
5:37:52 PM

S.W. GATE AOA TRK PTZ Site11-VR1-ETH1-C



6/21/2022
5:37:53 PM

S.W. GATE AOA TRK PTZ Site11-VR1-ETH1-C



ATTACHMENT 4: "SW GATE CAM01" CAMERA IMAGE SEQUENCE

6/21/2022
5:37:50 PM



0004

6/21/2022
5:37:50 PM



0005

6/21/2022
5:37:50 PM



00006

6/21/2022
5:37:51 PM



00007

6/21/2022
5:37:51 PM



0008

6/21/2022
5:37:51 PM



0009

6/21/2022
5:37:51 PM



00010

6/21/2022
5:37:51 PM



00011

6/21/2022
5:37:52 PM



00012

6/21/2022
5:37:52 PM



00013

6/21/2022
5:37:52 PM



00014

6/21/2022
5:37:52 PM



00015

6/21/2022
5:37:52 PM



00016

6/21/2022
5:37:53 PM



00017

6/21/2022
5:37:53 PM



6/21/2022
5:37:53 PM



6/21/2022
5:37:53 PM



00020

6/21/2022
5:37:53 PM



00021

6/21/2022
5:37:54 PM



00022

6/21/2022
5:37:54 PM



00023

6/21/2022
5:37:54 PM



00024

6/21/2022
5:37:54 PM



00025

6/21/2022
5:37:54 PM



00026

6/21/2022
5:37:55 PM



00027

6/21/2022
5:37:55 PM



00028

6/21/2022
5:37:55 PM



00029

6/21/2022
5:37:55 PM



00030

6/21/2022
5:37:55 PM



00031

6/21/2022
5:37:56 PM



00032

6/21/2022
5:37:56 PM



00033

6/21/2022
5:37:56 PM



00034

6/21/2022
5:37:56 PM



00035

6/21/2022
5:37:56 PM



00036

6/21/2022
5:37:57 PM



00037

6/21/2022
5:37:57 PM



00038

6/21/2022
5:37:57 PM



00039

6/21/2022
5:37:57 PM



00040

6/21/2022
5:37:57 PM



00041

6/21/2022
5:37:58 PM



00042

6/21/2022
5:37:58 PM



00043

6/21/2022
5:37:58 PM



00044

6/21/2022
5:37:58 PM



00045

6/21/2022
5:37:59 PM



00046

6/21/2022
5:37:59 PM



00047

6/21/2022
5:37:59 PM



00048

6/21/2022
5:37:59 PM



00049

6/21/2022
5:37:59 PM



00050

6/21/2022
5:38:00 PM



00051

6/21/2022
5:38:00 PM



00052

6/21/2022
5:38:00 PM



00053

6/21/2022
5:38:00 PM



00054

6/21/2022
5:38:00 PM



00055

6/21/2022
5:38:01 PM



00056

6/21/2022
5:38:01 PM



00057

6/21/2022
5:38:01 PM



00058

6/21/2022
5:38:01 PM



00059

6/21/2022
5:38:01 PM



00060

6/21/2022
5:38:01 PM



00061

6/21/2022
5:38:02 PM



00062

6/21/2022
5:38:02 PM



00063

6/21/2022
5:38:02 PM



00064

6/21/2022
5:38:03 PM



00065

6/21/2022
5:38:03 PM



00066

6/21/2022
5:38:03 PM



00067

6/21/2022
5:38:03 PM



00068

6/21/2022
5:38:03 PM



00069

6/21/2022
5:38:04 PM



00070

6/21/2022
5:38:04 PM



00071

6/21/2022
5:38:04 PM



00072

6/21/2022
5:38:04 PM



00073

6/21/2022
5:38:04 PM



00074

6/21/2022
5:38:04 PM



00075

6/21/2022
5:38:05 PM



00076

6/21/2022
5:38:05 PM



00077

6/21/2022
5:38:05 PM



00078

6/21/2022
5:38:05 PM



00079

6/21/2022
5:38:05 PM



0080

6/21/2022
5:38:06 PM



0081

6/21/2022
5:38:06 PM



00082

6/21/2022
5:38:06 PM



00083

6/21/2022
5:38:06 PM



00084

6/21/2022
5:38:07 PM



00085

6/21/2022
5:38:07 PM



00086

6/21/2022
5:38:07 PM



00087

6/21/2022
5:38:07 PM



00088

6/21/2022
5:38:07 PM



00089

6/21/2022
5:38:07 PM



00090

6/21/2022
5:38:08 PM



00091

6/21/2022
5:38:08 PM



00092

6/21/2022
5:38:08 PM



00093

6/21/2022
5:38:08 PM



00094

6/21/2022
5:38:08 PM



00095

6/21/2022
5:38:09 PM



00096

6/21/2022
5:38:09 PM



00097

6/21/2022
5:38:09 PM



00098

6/21/2022
5:38:09 PM



00099

6/21/2022
5:38:09 PM



00100

6/21/2022
5:38:10 PM



00101

6/21/2022
5:38:10 PM



00102

6/21/2022
5:38:10 PM



00103

6/21/2022
5:38:10 PM



00104

6/21/2022
5:38:10 PM



00105

6/21/2022
5:38:11 PM



00106

6/21/2022
5:38:11 PM



00107

6/21/2022
5:38:11 PM



00108

6/21/2022
5:38:11 PM



00109

6/21/2022
5:38:11 PM



00110

6/21/2022
5:38:12 PM



00111

6/21/2022
5:38:12 PM



00112

6/21/2022
5:38:12 PM



00113

6/21/2022
5:38:12 PM



00114

6/21/2022
5:38:12 PM



00115

6/21/2022
5:38:12 PM



00116

6/21/2022
5:38:13 PM



00117

6/21/2022
5:38:13 PM



00118

6/21/2022
5:38:13 PM



00119

6/21/2022
5:38:13 PM



00120

6/21/2022
5:38:13 PM



00121

6/21/2022
5:38:14 PM



00122

6/21/2022
5:38:14 PM



00123

6/21/2022
5:38:14 PM



00124

6/21/2022
5:38:14 PM



00125

6/21/2022
5:38:15 PM



00126

6/21/2022
5:38:15 PM



00127

6/21/2022
5:38:15 PM



00128

6/21/2022
5:38:15 PM



00129

6/21/2022
5:38:15 PM



00130

6/21/2022
5:38:15 PM



00131

6/21/2022
5:38:16 PM



00132

6/21/2022
5:38:16 PM



00133

6/21/2022
5:38:16 PM



00134

6/21/2022
5:38:16 PM



00135

6/21/2022
5:38:16 PM



00136

6/21/2022
5:38:17 PM



00137

6/21/2022
5:38:17 PM



00138

6/21/2022
5:38:17 PM



00139

6/21/2022
5:38:17 PM



00140

6/21/2022
5:38:17 PM



00141

6/21/2022
5:38:18 PM



00142

6/21/2022
5:38:18 PM



00143

6/21/2022
5:38:18 PM



00144

6/21/2022
5:38:18 PM



00145

6/21/2022
5:38:18 PM



00146

6/21/2022
5:38:19 PM



00147

6/21/2022
5:38:19 PM



00148

6/21/2022
5:38:19 PM



00149

6/21/2022
5:38:19 PM



00150

6/21/2022
5:38:19 PM



00151

6/21/2022
5:38:19 PM



00152

6/21/2022
5:38:20 PM



00153

6/21/2022
5:38:20 PM



00154

6/21/2022
5:38:20 PM



00155

6/21/2022
5:38:20 PM



00156

6/21/2022
5:38:21 PM



00157

6/21/2022
5:38:21 PM



00158

6/21/2022
5:38:21 PM



00159

6/21/2022
5:38:21 PM



00160

6/21/2022
5:38:21 PM



00161

6/21/2022
5:38:22 PM



00162

6/21/2022
5:38:22 PM



00163

6/21/2022
5:38:22 PM



00164

6/21/2022
5:38:22 PM



00165

6/21/2022
5:38:22 PM



00166

6/21/2022
5:38:23 PM



00167

6/21/2022
5:38:23 PM



00168

6/21/2022
5:38:23 PM



00169

6/21/2022
5:38:23 PM



00170

6/21/2022
5:38:23 PM



00171

6/21/2022
5:38:23 PM



00172

6/21/2022
5:38:24 PM



00173

6/21/2022
5:38:24 PM



00174

6/21/2022
5:38:24 PM



00175

6/21/2022
5:38:24 PM



00176

6/21/2022
5:38:24 PM



00177

6/21/2022
5:38:25 PM



00178

6/21/2022
5:38:25 PM



00179

6/21/2022
5:38:25 PM



00180

6/21/2022
5:38:25 PM



00181

6/21/2022
5:38:25 PM



00182

6/21/2022
5:38:26 PM



00183

6/21/2022
5:38:26 PM



00184

6/21/2022
5:38:26 PM



00185

6/21/2022
5:38:26 PM



00186

6/21/2022
5:38:26 PM



00187

6/21/2022
5:38:27 PM



00188

6/21/2022
5:38:27 PM



00189

6/21/2022
5:38:27 PM



00190

6/21/2022
5:38:27 PM



00191

6/21/2022
5:38:27 PM



00192

6/21/2022
5:38:27 PM



00193

6/21/2022
5:38:28 PM



00194

6/21/2022
5:38:28 PM



00195

6/21/2022
5:38:28 PM



00196

6/21/2022
5:38:28 PM



00197

6/21/2022
5:38:29 PM



00198

6/21/2022
5:38:29 PM



00199

6/21/2022
5:38:29 PM



00200

6/21/2022
5:38:29 PM



00201

6/21/2022
5:38:29 PM



00202

6/21/2022
5:38:29 PM



00203

6/21/2022
5:38:30 PM



00204

6/21/2022
5:38:30 PM



00205

6/21/2022
5:38:30 PM



00206

6/21/2022
5:38:30 PM



00207

6/21/2022
5:38:30 PM



00208

6/21/2022
5:38:31 PM



00209

6/21/2022
5:38:31 PM



00210

6/21/2022
5:38:31 PM



00211

6/21/2022
5:38:31 PM



00212

6/21/2022
5:38:31 PM



00213

6/21/2022
5:38:32 PM



00214

6/21/2022
5:38:32 PM



00215

6/21/2022
5:38:32 PM



00216

6/21/2022
5:38:32 PM



00217

6/21/2022
5:38:32 PM



00218

6/21/2022
5:38:32 PM



00219

6/21/2022
5:38:33 PM



00220

6/21/2022
5:38:33 PM



00221

ATTACHMENT 5: "TUNNEL AIRSIDE SOUTH" CAMERA IMAGE SEQUENCE

6/21/2022
5:38:18 PM



00082

6/21/2022
5:38:18 PM



00083

6/21/2022
5:38:19 PM



00084

6/21/2022
5:38:19 PM



00085

6/21/2022
5:38:19 PM



00086

6/21/2022
5:38:19 PM



00087

6/21/2022
5:38:20 PM



00088

6/21/2022
5:38:20 PM



00089

6/21/2022
5:38:20 PM



00090

6/21/2022
5:38:20 PM



00091

6/21/2022
5:38:20 PM



00092

6/21/2022
5:38:21 PM



00093

6/21/2022
5:38:21 PM



00094

6/21/2022
5:38:21 PM



00095

6/21/2022
5:38:22 PM



00096

6/21/2022
5:38:22 PM



00097

6/21/2022
5:38:22 PM



00098

6/21/2022
5:38:22 PM

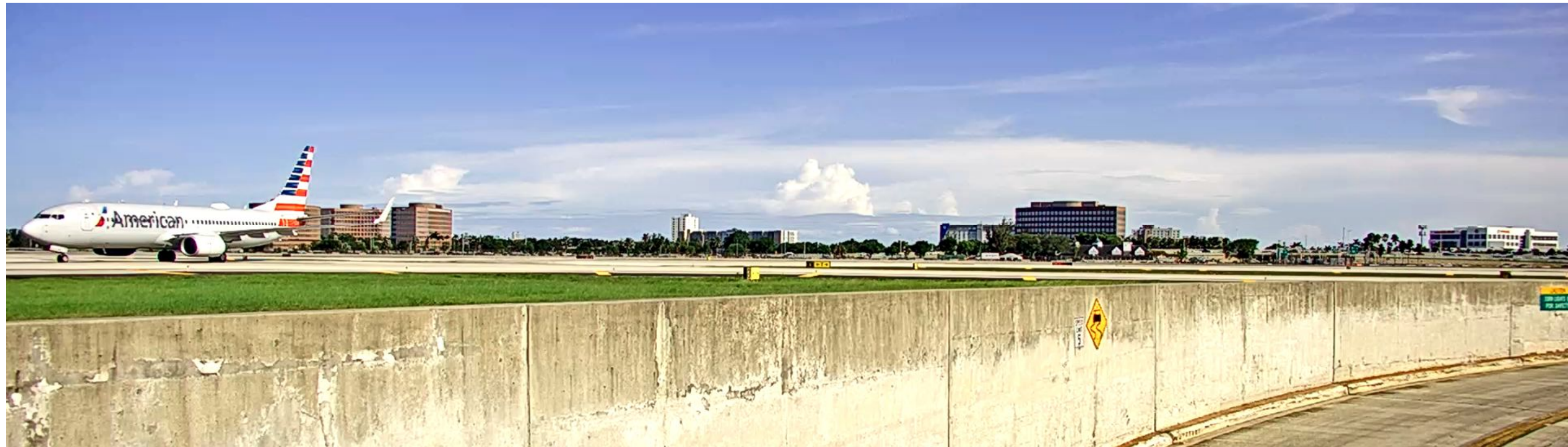

00099

6/21/2022
5:38:22 PM



00100

6/21/2022
5:38:23 PM



00101

6/21/2022
5:38:23 PM



00102

6/21/2022
5:38:23 PM



00103

6/21/2022
5:38:23 PM



00104

6/21/2022
5:38:24 PM



00105

6/21/2022
5:38:24 PM



00106

6/21/2022
5:38:24 PM



00107

6/21/2022
5:38:24 PM



00108

6/21/2022
5:38:25 PM



00109

6/21/2022
5:38:25 PM



00110

6/21/2022
5:38:25 PM



00111

6/21/2022
5:38:25 PM



00112

6/21/2022
5:38:25 PM



00113

6/21/2022
5:38:26 PM



00114

6/21/2022
5:38:26 PM



00115

6/21/2022
5:38:26 PM



00116

6/21/2022
5:38:26 PM



00117

6/21/2022
5:38:26 PM



00118

6/21/2022
5:38:27 PM



00119

6/21/2022
5:38:27 PM



00120

6/21/2022
5:38:27 PM



00121

6/21/2022
5:38:27 PM



00122

6/21/2022
5:38:28 PM



00123

6/21/2022
5:38:28 PM



00124

6/21/2022
5:38:28 PM



00125

6/21/2022
5:38:29 PM



00126

6/21/2022
5:38:29 PM



00127

6/21/2022
5:38:29 PM



00128

6/21/2022
5:38:29 PM



00129

6/21/2022
5:38:29 PM



00130

6/21/2022
5:38:29 PM



00131

6/21/2022
5:38:30 PM



00132

6/21/2022
5:38:30 PM



00133

6/21/2022
5:38:30 PM



00134

6/21/2022
5:38:30 PM



00135

6/21/2022
5:38:31 PM



00136

6/21/2022
5:38:31 PM



00137

6/21/2022
5:38:31 PM



00138

6/21/2022
5:38:31 PM



00139

6/21/2022
5:38:31 PM



00140

6/21/2022
5:38:32 PM



00141

6/21/2022
5:38:32 PM



00142

6/21/2022
5:38:32 PM



00143

6/21/2022
5:38:32 PM



00144

6/21/2022
5:38:33 PM



00145

6/21/2022
5:38:33 PM



00146

6/21/2022
5:38:33 PM



00147

6/21/2022
5:38:33 PM



00148

6/21/2022
5:38:34 PM



00149

6/21/2022
5:38:34 PM



00150

6/21/2022
5:38:34 PM



00151

6/21/2022
5:38:34 PM



00152

6/21/2022
5:38:34 PM



00153

6/21/2022
5:38:35 PM



00154

6/21/2022
5:38:35 PM



00155

6/21/2022
5:38:35 PM



00156

6/21/2022
5:38:35 PM



00157

6/21/2022
5:38:36 PM



00158

6/21/2022
5:38:36 PM



00159

6/21/2022
5:38:36 PM



00160

6/21/2022
5:38:36 PM



00161

6/21/2022
5:38:37 PM



00162

6/21/2022
5:38:37 PM



00163

6/21/2022
5:38:37 PM



00164

6/21/2022
5:38:37 PM



00165

6/21/2022
5:38:37 PM



00166

6/21/2022
5:38:38 PM



00167

6/21/2022
5:38:38 PM



00168

6/21/2022
5:38:38 PM



00169

6/21/2022
5:38:39 PM



00170

6/21/2022
5:38:39 PM



00171

6/21/2022
5:38:39 PM



00172

6/21/2022
5:38:39 PM



00173

6/21/2022
5:38:39 PM



00174

6/21/2022
5:38:39 PM



00175

6/21/2022
5:38:40 PM



00176

6/21/2022
5:38:40 PM



00177

6/21/2022
5:38:40 PM



00178

6/21/2022
5:38:40 PM



00179

6/21/2022
5:38:40 PM



00180

6/21/2022
5:38:41 PM



00181

ATTACHMENT 6: "TAXIWAY T3" CAMERA IMAGE SEQUENCE

6/21/2022
5:38:06 PM

Taxiway T3 AOA Serv. Road TRK PTZ Site0



00100

6/21/2022
5:38:06 PM

Taxiway T3 AOA Serv. Road TRK PTZ Site0



00101

6/21/2022
5:38:06 PM

Taxiway T3 AOA Serv. Road TRK PTZ Site0



00102

6/21/2022
5:38:06 PM

Taxiway T3 AOA Serv. Road TRK PTZ Site0



00103

6/21/2022
5:38:06 PM

Taxiway T3 AOA Serv. Road TRK PTZ Site0



00104

6/21/2022
5:38:06 PM

Taxiway T3 AOA Serv. Road TRK PTZ Site0



00105

6/21/2022
5:38:06 PM

Taxiway T3 AOA Serv. Road TRK PTZ Site0



00106

6/21/2022
5:38:06 PM

Taxiway T3 AOA Serv. Road TRK PTZ Site0



00107

6/21/2022
5:38:07 PM

Taxiway T3 AOA Serv. Road TRK PTZ Site0



00108

6/21/2022
5:38:07 PM

Taxiway T3 AOA Serv. Road TRK PTZ Site0



00109

6/21/2022
5:38:07 PM

Taxiway T3 AOA Serv. Road TRK PTZ Site0



00110

6/21/2022
5:38:07 PM

Taxiway T3 AOA Serv. Road TRK PTZ Site0



00111

6/21/2022
5:38:07 PM

Taxiway T3 AOA Serv. Road TRK PTZ Site0



00112

6/21/2022
5:38:07 PM

Taxiway T3 AOA Serv. Road TRK PTZ Site0



00113

6/21/2022
5:38:07 PM

Taxiway T3 AOA Serv. Road TRK PTZ Site0



00114

6/21/2022
5:38:07 PM

Taxiway T3 AOA Serv. Road TRK PTZ Site0



00115

6/21/2022
5:38:07 PM

Taxiway T3 AOA Serv. Road TRK PTZ Site0



00116

6/21/2022
5:38:07 PM

Taxiway T3 AOA Serv. Road TRK PTZ Site0



00117

6/21/2022
5:38:07 PM

Taxiway T3 AOA Serv. Road TRK PTZ Site0



00118

6/21/2022
5:38:07 PM

Taxiway T3 AOA Serv. Road TRK PTZ Site0



00119

6/21/2022
5:38:07 PM

Taxiway T3 AOA Serv. Road TRK PTZ Site0



00120

6/21/2022
5:38:07 PM

Taxiway T3 AOA Serv. Road TRK PTZ Site0



00121

6/21/2022
5:38:08 PM

Taxiway T3 AOA Serv. Road TRK PTZ Site0



00122

6/21/2022
5:38:08 PM

Taxiway T3 AOA Serv. Road TRK PTZ Site0



00123

6/21/2022
5:38:08 PM

Taxiway T3 AOA Serv. Road TRK PTZ Site0



00124

6/21/2022
5:38:08 PM

Taxiway T3 AOA Serv. Road TRK PTZ Site0



00125

6/21/2022
5:38:08 PM

Taxiway T3 AOA Serv. Road TRK PTZ Site0



00126

6/21/2022
5:38:08 PM

Taxiway T3 AOA Serv. Road TRK PTZ Site0



00127

6/21/2022
5:38:08 PM

Taxiway T3 AOA Serv. Road TRK PTZ Site0



00128

6/21/2022
5:38:08 PM

Taxiway T3 AOA Serv. Road TRK PTZ Site0



00129

6/21/2022
5:38:08 PM

Taxiway T3 AOA Serv. Road TRK PTZ Site0



00130

6/21/2022
5:38:08 PM

Taxiway T3 AOA Serv. Road TRK PTZ Site0



00131

6/21/2022
5:38:08 PM

Taxiway T3 AOA Serv. Road TRK PTZ Site0



00132

6/21/2022
5:38:08 PM

Taxiway T3 AOA Serv. Road TRK PTZ Site0



00133

6/21/2022
5:38:08 PM

Taxiway T3 AOA Serv. Road TRK PTZ Site0



00134

6/21/2022
5:38:08 PM

Taxiway T3 AOA Serv. Road TRK PTZ Site0



00135

6/21/2022
5:38:08 PM

Taxiway T3 AOA Serv. Road TRK PTZ Site0



00136

6/21/2022
5:38:09 PM

Taxiway T3 AOA Serv. Road TRK PTZ Site0



00137

6/21/2022
5:38:09 PM

Taxiway T3 AOA Serv. Road TRK PTZ Site0



00138

6/21/2022
5:38:09 PM

Taxiway T3 AOA Serv. Road TRK PTZ Site0



00139

6/21/2022
5:38:09 PM

Taxiway T3 AOA Serv. Road TRK PTZ Site0



00140

6/21/2022
5:38:09 PM

Taxiway T3 AOA Serv. Road TRK PTZ Site0



00141

6/21/2022
5:38:09 PM

Taxiway T3 AOA Serv. Road TRK PTZ Site0



00142

6/21/2022
5:38:09 PM

Taxiway T3 AOA Serv. Road TRK PTZ Site0



00143

6/21/2022
5:38:09 PM

Taxiway T3 AOA Serv. Road TRK PTZ Site0



00144

6/21/2022
5:38:09 PM

Taxiway T3 AOA Serv. Road TRK PTZ Site0



00145

6/21/2022
5:38:09 PM

Taxiway T3 AOA Serv. Road TRK PTZ Site0



00146

6/21/2022
5:38:09 PM

Taxiway T3 AOA Serv. Road TRK PTZ Site0



00147

6/21/2022
5:38:09 PM

Taxiway T3 AOA Serv. Road TRK PTZ Site0



00148

6/21/2022
5:38:09 PM

Taxiway T3 AOA Serv. Road TRK PTZ Site0



00149

6/21/2022
5:38:09 PM

Taxiway T3 AOA Serv. Road TRK PTZ Site0



00150

6/21/2022
5:38:09 PM

Taxiway T3 AOA Serv. Road TRK PTZ Site0



00151

6/21/2022
5:38:10 PM

Taxiway T3 AOA Serv. Road TRK PTZ Site0



00152

6/21/2022
5:38:10 PM

Taxiway T3 AOA Serv. Road TRK PTZ Site0



00153

6/21/2022
5:38:10 PM

Taxiway T3 AOA Serv. Road TRK PTZ Site0



00154

6/21/2022
5:38:10 PM

Taxiway T3 AOA Serv. Road TRK PTZ Site0



00155

6/21/2022
5:38:10 PM

Taxiway T3 AOA Serv. Road TRK PTZ Site0



00156

6/21/2022
5:38:10 PM

Taxiway T3 AOA Serv. Road TRK PTZ Site0



00157

6/21/2022
5:38:10 PM

Taxiway T3 AOA Serv. Road TRK PTZ Site0



00158

6/21/2022
5:38:10 PM

Taxiway T3 AOA Serv. Road TRK PTZ Site0



00159

6/21/2022
5:38:10 PM

Taxiway T3 AOA Serv. Road TRK PTZ Site0



00160

6/21/2022
5:38:10 PM

Taxiway T3 AOA Serv. Road TRK PTZ Site0



00161

6/21/2022
5:38:10 PM

Taxiway T3 AOA Serv. Road TRK PTZ Site0



00162

6/21/2022
5:38:10 PM

Taxiway T3 AOA Serv. Road TRK PTZ Site0



00163

6/21/2022
5:38:10 PM

Taxiway T3 AOA Serv. Road TRK PTZ Site0



00164

6/21/2022
5:38:10 PM

Taxiway T3 AOA Serv. Road TRK PTZ Site0



00165

6/21/2022
5:38:10 PM

Taxiway T3 AOA Serv. Road TRK PTZ Site0



00166

6/21/2022
5:38:11 PM

Taxiway T3 AOA Serv. Road TRK PTZ Site0



00167

6/21/2022
5:38:11 PM

Taxiway T3 AOA Serv. Road TRK PTZ Site0



00168

6/21/2022
5:38:11 PM

Taxiway T3 AOA Serv. Road TRK PTZ Site0



00169

6/21/2022
5:38:11 PM

Taxiway T3 AOA Serv. Road TRK PTZ Site0



00170

6/21/2022
5:38:11 PM

Taxiway T3 AOA Serv. Road TRK PTZ Site0



00171

6/21/2022
5:38:11 PM

Taxiway T3 AOA Serv. Road TRK PTZ Site0



00172

6/21/2022
5:38:11 PM

Taxiway T3 AOA Serv. Road TRK PTZ Site0



00173

6/21/2022
5:38:11 PM

Taxiway T3 AOA Serv. Road TRK PTZ Site0



00174

6/21/2022
5:38:11 PM

Taxiway T3 AOA Serv. Road TRK PTZ Site0



00175

6/21/2022
5:38:11 PM

Taxiway T3 AOA Serv. Road TRK PTZ Site0



00176

6/21/2022
5:38:11 PM

Taxiway T3 AOA Serv. Road TRK PTZ Site0



00177

6/21/2022
5:38:11 PM

Taxiway T3 AOA Serv. Road TRK PTZ Site0



00178

6/21/2022
5:38:11 PM

Taxiway T3 AOA Serv. Road TRK PTZ Site0



00179

6/21/2022
5:38:11 PM

Taxiway T3 AOA Serv. Road TRK PTZ Site0



00180

6/21/2022
5:38:11 PM

Taxiway T3 AOA Serv. Road TRK PTZ Site0



00181

6/21/2022
5:38:12 PM

Taxiway T3 AOA Serv. Road TRK PTZ Site0



00182

6/21/2022
5:38:12 PM

Taxiway T3 AOA Serv. Road TRK PTZ Site0



00183

6/21/2022
5:38:12 PM

Taxiway T3 AOA Serv. Road TRK PTZ Site0



00184

6/21/2022
5:38:12 PM

Taxiway T3 AOA Serv. Road TRK PTZ Site0



00185

6/21/2022
5:38:12 PM

Taxiway T3 AOA Serv. Road TRK PTZ Site0



00186

6/21/2022
5:38:12 PM

Taxiway T3 AOA Serv. Road TRK PTZ Site0



00187

6/21/2022
5:38:12 PM

Taxiway T3 AOA Serv. Road TRK PTZ Site0



00188

6/21/2022
5:38:12 PM

Taxiway T3 AOA Serv. Road TRK PTZ Site0



00189

6/21/2022
5:38:12 PM

Taxiway T3 AOA Serv. Road TRK PTZ Site0



00190

6/21/2022
5:38:12 PM

Taxiway T3 AOA Serv. Road TRK PTZ Site0



00191

6/21/2022
5:38:12 PM

Taxiway T3 AOA Serv. Road TRK PTZ Site0



00192

6/21/2022
5:38:12 PM

Taxiway T3 AOA Serv. Road TRK PTZ Site0



00193

6/21/2022
5:38:12 PM

Taxiway T3 AOA Serv. Road TRK PTZ Site0



00194

6/21/2022
5:38:12 PM

Taxiway T3 AOA Serv. Road TRK PTZ Site0



00195

6/21/2022
5:38:12 PM

Taxiway T3 AOA Serv. Road TRK PTZ Site0



00196

6/21/2022
5:38:13 PM

Taxiway T3 AOA Serv. Road TRK PTZ Site0



00197

6/21/2022
5:38:13 PM

Taxiway T3 AOA Serv. Road TRK PTZ Site0



00198

6/21/2022
5:38:13 PM

Taxiway T3 AOA Serv. Road TRK PTZ Site0



00199

6/21/2022
5:38:13 PM

Taxiway T3 AOA Serv. Road TRK PTZ Site0



00200

6/21/2022
5:38:13 PM

Taxiway T3 AOA Serv. Road TRK PTZ Site0



00201

6/21/2022
5:38:13 PM

Taxiway T3 AOA Serv. Road TRK PTZ Site0



00202

6/21/2022
5:38:13 PM

Taxiway T3 AOA Serv. Road TRK PTZ Site0



00203

6/21/2022
5:38:13 PM

Taxiway T3 AOA Serv. Road TRK PTZ Site0



00204

6/21/2022
5:38:13 PM

Taxiway T3 AOA Serv. Road TRK PTZ Site0



00205

6/21/2022
5:38:13 PM

Taxiway T3 AOA Serv. Road TRK PTZ Site0



00206

6/21/2022
5:38:13 PM

Taxiway T3 AOA Serv. Road TRK PTZ Site0



00207

6/21/2022
5:38:13 PM

Taxiway T3 AOA Serv. Road TRK PTZ Site0



00208

6/21/2022
5:38:13 PM

Taxiway T3 AOA Serv. Road TRK PTZ Site0



00209

6/21/2022
5:38:13 PM

Taxiway T3 AOA Serv. Road TRK PTZ Site0



00210

6/21/2022
5:38:13 PM

Taxiway T3 AOA Serv. Road TRK PTZ Site0



00211

6/21/2022
5:38:14 PM

Taxiway T3 AOA Serv. Road TRK PTZ Site0



00212

6/21/2022
5:38:14 PM

Taxiway T3 AOA Serv. Road TRK PTZ Site0



00213

6/21/2022
5:38:14 PM

Taxiway T3 AOA Serv. Road TRK PTZ Site0



00214

6/21/2022
5:38:14 PM

Taxiway T3 AOA Serv. Road TRK PTZ Site0



00215

6/21/2022
5:38:14 PM

Taxiway T3 AOA Serv. Road TRK PTZ Site0



00216

6/21/2022
5:38:14 PM

Taxiway T3 AOA Serv. Road TRK PTZ Site0



00217

6/21/2022
5:38:14 PM

Taxiway T3 AOA Serv. Road TRK PTZ Site0



00218

6/21/2022
5:38:14 PM

Taxiway T3 AOA Serv. Road TRK PTZ Site0



00219

6/21/2022
5:38:14 PM

Taxiway T3 AOA Serv. Road TRK PTZ Site0



00220

6/21/2022
5:38:14 PM

Taxiway T3 AOA Serv. Road TRK PTZ Site0



00221

6/21/2022
5:38:14 PM

Taxiway T3 AOA Serv. Road TRK PTZ Site0



00222

6/21/2022
5:38:14 PM

Taxiway T3 AOA Serv. Road TRK PTZ Site0



00223

6/21/2022
5:38:14 PM

Taxiway T3 AOA Serv. Road TRK PTZ Site0



00224

6/21/2022
5:38:14 PM

Taxiway T3 AOA Serv. Road TRK PTZ Site0



00225

6/21/2022
5:38:14 PM

Taxiway T3 AOA Serv. Road TRK PTZ Site0



00226

6/21/2022
5:38:15 PM

Taxiway T3 AOA Serv. Road TRK PTZ Site0



00227

6/21/2022
5:38:15 PM

Taxiway T3 AOA Serv. Road TRK PTZ Site0



00228

6/21/2022
5:38:15 PM

Taxiway T3 AOA Serv. Road TRK PTZ Site0



00229

6/21/2022
5:38:15 PM

Taxiway T3 AOA Serv. Road TRK PTZ Site0



00230

6/21/2022
5:38:15 PM

Taxiway T3 AOA Serv. Road TRK PTZ Site0



00231

6/21/2022
5:38:15 PM

Taxiway T3 AOA Serv. Road TRK PTZ Site0



00232

6/21/2022
5:38:15 PM

Taxiway T3 AOA Serv. Road TRK PTZ Site0



00233

6/21/2022
5:38:15 PM

Taxiway T3 AOA Serv. Road TRK PTZ Site0



00234

6/21/2022
5:38:15 PM

Taxiway T3 AOA Serv. Road TRK PTZ Site0



00235

6/21/2022
5:38:15 PM

Taxiway T3 AOA Serv. Road TRK PTZ Site0



00236

6/21/2022
5:38:15 PM

Taxiway T3 AOA Serv. Road TRK PTZ Site0



00237

6/21/2022
5:38:15 PM

Taxiway T3 AOA Serv. Road TRK PTZ Site0



00238

6/21/2022
5:38:15 PM

Taxiway T3 AOA Serv. Road TRK PTZ Site0



00239

6/21/2022
5:38:15 PM

Taxiway T3 AOA Serv. Road TRK PTZ Site0



00240

6/21/2022
5:38:15 PM

Taxiway T3 AOA Serv. Road TRK PTZ Site0



00241

6/21/2022
5:38:16 PM

Taxiway T3 AOA Serv. Road TRK PTZ Site0



00242

6/21/2022
5:38:16 PM

Taxiway T3 AOA Serv. Road TRK PTZ Site0



00243

6/21/2022
5:38:16 PM

Taxiway T3 AOA Serv. Road TRK PTZ Site0



00244

6/21/2022
5:38:16 PM

Taxiway T3 AOA Serv. Road TRK PTZ Site0



00245

6/21/2022
5:38:16 PM

Taxiway T3 AOA Serv. Road TRK PTZ Site0



00246

6/21/2022
5:38:16 PM

Taxiway T3 AOA Serv. Road TRK PTZ Site0



00247

6/21/2022
5:38:16 PM

Taxiway T3 AOA Serv. Road TRK PTZ Site0



00248

6/21/2022
5:38:16 PM

Taxiway T3 AOA Serv. Road TRK PTZ Site0



00249

6/21/2022
5:38:16 PM

Taxiway T3 AOA Serv. Road TRK PTZ Site0



00250

6/21/2022
5:38:16 PM

Taxiway T3 AOA Serv. Road TRK PTZ Site0



00251

6/21/2022
5:38:16 PM

Taxiway T3 AOA Serv. Road TRK PTZ Site0



00252

6/21/2022
5:38:16 PM

Taxiway T3 AOA Serv. Road TRK PTZ Site0



00253

6/21/2022
5:38:16 PM

Taxiway T3 AOA Serv. Road TRK PTZ Site0



00254

6/21/2022
5:38:16 PM

Taxiway T3 AOA Serv. Road TRK PTZ Site0



00255

6/21/2022
5:38:16 PM

Taxiway T3 AOA Serv. Road TRK PTZ Site0



00256

6/21/2022
5:38:17 PM

Taxiway T3 AOA Serv. Road TRK PTZ Site0



00257

6/21/2022
5:38:17 PM

Taxiway T3 AOA Serv. Road TRK PTZ Site0



00258

6/21/2022
5:38:17 PM

Taxiway T3 AOA Serv. Road TRK PTZ Site0



00259

6/21/2022
5:38:17 PM

Taxiway T3 AOA Serv. Road TRK PTZ Site0



00260

6/21/2022
5:38:17 PM

Taxiway T3 AOA Serv. Road TRK PTZ Site0



00261

6/21/2022
5:38:17 PM

Taxiway T3 AOA Serv. Road TRK PTZ Site0



00262

6/21/2022
5:38:17 PM

Taxiway T3 AOA Serv. Road TRK PTZ Site0



00263

6/21/2022
5:38:17 PM

Taxiway T3 AOA Serv. Road TRK PTZ Site0



00264

6/21/2022
5:38:17 PM

Taxiway T3 AOA Serv. Road TRK PTZ Site0



00265

6/21/2022
5:38:17 PM

Taxiway T3 AOA Serv. Road TRK PTZ Site0



00266

6/21/2022
5:38:17 PM

Taxiway T3 AOA Serv. Road TRK PTZ Site0



00267

6/21/2022
5:38:17 PM

Taxiway T3 AOA Serv. Road TRK PTZ Site0



00268

6/21/2022
5:38:17 PM

Taxiway T3 AOA Serv. Road TRK PTZ Site0



00269

6/21/2022
5:38:17 PM

Taxiway T3 AOA Serv. Road TRK PTZ Site0



00270

6/21/2022
5:38:17 PM

Taxiway T3 AOA Serv. Road TRK PTZ Site0



00271

6/21/2022
5:38:18 PM

Taxiway T3 AOA Serv. Road TRK PTZ Site0



00272

6/21/2022
5:38:18 PM

Taxiway T3 AOA Serv. Road TRK PTZ Site0



00273

6/21/2022
5:38:18 PM

Taxiway T3 AOA Serv. Road TRK PTZ Site0



00274

6/21/2022
5:38:18 PM

Taxiway T3 AOA Serv. Road TRK PTZ Site0



00275

6/21/2022
5:38:18 PM

Taxiway T3 AOA Serv. Road TRK PTZ Site0



00276

6/21/2022
5:38:18 PM

Taxiway T3 AOA Serv. Road TRK PTZ Site0



00277

6/21/2022
5:38:18 PM

Taxiway T3 AOA Serv. Road TRK PTZ Site0



00278

6/21/2022
5:38:18 PM

Taxiway T3 AOA Serv. Road TRK PTZ Site0



00279

6/21/2022
5:38:18 PM

Taxiway T3 AOA Serv. Road TRK PTZ Site0



00280

6/21/2022
5:38:18 PM

Taxiway T3 AOA Serv. Road TRK PTZ Site0



00281

6/21/2022
5:38:18 PM

Taxiway T3 AOA Serv. Road TRK PTZ Site0



00282

6/21/2022
5:38:18 PM

Taxiway T3 AOA Serv. Road TRK PTZ Site0



00283

6/21/2022
5:38:18 PM

Taxiway T3 AOA Serv. Road TRK PTZ Site0



00284

6/21/2022
5:38:18 PM

Taxiway T3 AOA Serv. Road TRK PTZ Site0



00285

6/21/2022
5:38:18 PM

Taxiway T3 AOA Serv. Road TRK PTZ Site0



00286

6/21/2022
5:38:19 PM

Taxiway T3 AOA Serv. Road TRK PTZ Site0



00287

6/21/2022
5:38:19 PM

Taxiway T3 AOA Serv. Road TRK PTZ Site0



00288

6/21/2022
5:38:19 PM

Taxiway T3 AOA Serv. Road TRK PTZ Site0



00289

6/21/2022
5:38:19 PM

Taxiway T3 AOA Serv. Road TRK PTZ Site0



00290

6/21/2022
5:38:19 PM

Taxiway T3 AOA Serv. Road TRK PTZ Site0



00291

6/21/2022
5:38:19 PM

Taxiway T3 AOA Serv. Road TRK PTZ Site0



00292

6/21/2022
5:38:19 PM

Taxiway T3 AOA Serv. Road TRK PTZ Site0



00293

6/21/2022
5:38:19 PM

Taxiway T3 AOA Serv. Road TRK PTZ Site0



00294

6/21/2022
5:38:19 PM

Taxiway T3 AOA Serv. Road TRK PTZ Site0



00295

6/21/2022
5:38:19 PM

Taxiway T3 AOA Serv. Road TRK PTZ Site0



00296

6/21/2022
5:38:19 PM

Taxiway T3 AOA Serv. Road TRK PTZ Site0



00297

6/21/2022
5:38:19 PM

Taxiway T3 AOA Serv. Road TRK PTZ Site0



00298

6/21/2022
5:38:19 PM

Taxiway T3 AOA Serv. Road TRK PTZ Site0



00299

6/21/2022
5:38:19 PM

Taxiway T3 AOA Serv. Road TRK PTZ Site0



00300

6/21/2022
5:38:19 PM

Taxiway T3 AOA Serv. Road TRK PTZ Site0



00301

6/21/2022
5:38:20 PM

Taxiway T3 AOA Serv. Road TRK PTZ Site0



00302

6/21/2022
5:38:20 PM

Taxiway T3 AOA Serv. Road TRK PTZ Site0



00303

6/21/2022
5:38:20 PM

Taxiway T3 AOA Serv. Road TRK PTZ Site0



00304

6/21/2022
5:38:20 PM

Taxiway T3 AOA Serv. Road TRK PTZ Site0



00305

6/21/2022
5:38:20 PM

Taxiway T3 AOA Serv. Road TRK PTZ Site0



00306

6/21/2022
5:38:20 PM

Taxiway T3 AOA Serv. Road TRK PTZ Site0



00307

6/21/2022
5:38:20 PM

Taxiway T3 AOA Serv. Road TRK PTZ Site0



00308

6/21/2022
5:38:20 PM

Taxiway T3 AOA Serv. Road TRK PTZ Site0



00309

6/21/2022
5:38:20 PM

Taxiway T3 AOA Serv. Road TRK PTZ Site0



00310

6/21/2022
5:38:20 PM

Taxiway T3 AOA Serv. Road TRK PTZ Site0



00311

6/21/2022
5:38:20 PM

Taxiway T3 AOA Serv. Road TRK PTZ Site0



00312

6/21/2022
5:38:20 PM

Taxiway T3 AOA Serv. Road TRK PTZ Site0



00313

6/21/2022
5:38:20 PM

Taxiway T3 AOA Serv. Road TRK PTZ Site0



00314

6/21/2022
5:38:20 PM

Taxiway T3 AOA Serv. Road TRK PTZ Site0



00315

6/21/2022
5:38:20 PM

Taxiway T3 AOA Serv. Road TRK PTZ Site0



00316

6/21/2022
5:38:21 PM

Taxiway T3 AOA Serv. Road TRK PTZ Site0



00317

6/21/2022
5:38:21 PM

Taxiway T3 AOA Serv. Road TRK PTZ Site0



00318

6/21/2022
5:38:21 PM

Taxiway T3 AOA Serv. Road TRK PTZ Site0



00319

6/21/2022
5:38:21 PM

Taxiway T3 AOA Serv. Road TRK PTZ Site0



00320

6/21/2022
5:38:21 PM

Taxiway T3 AOA Serv. Road TRK PTZ Site0



00321

6/21/2022
5:38:21 PM

Taxiway T3 AOA Serv. Road TRK PTZ Site0



00322

6/21/2022
5:38:21 PM

Taxiway T3 AOA Serv. Road TRK PTZ Site0



00323

6/21/2022
5:38:21 PM

Taxiway T3 AOA Serv. Road TRK PTZ Site0



00324

6/21/2022
5:38:21 PM

Taxiway T3 AOA Serv. Road TRK PTZ Site0



00325

6/21/2022
5:38:21 PM

Taxiway T3 AOA Serv. Road TRK PTZ Site0



00326

6/21/2022
5:38:21 PM

Taxiway T3 AOA Serv. Road TRK PTZ Site0



00327

6/21/2022
5:38:21 PM

Taxiway T3 AOA Serv. Road TRK PTZ Site0



00328

6/21/2022
5:38:21 PM

Taxiway T3 AOA Serv. Road TRK PTZ Site0



00329

6/21/2022
5:38:21 PM

Taxiway T3 AOA Serv. Road TRK PTZ Site0



00330

6/21/2022
5:38:22 PM

Taxiway T3 AOA Serv. Road TRK PTZ Site0



00331

6/21/2022
5:38:22 PM

Taxiway T3 AOA Serv. Road TRK PTZ Site0



00332

6/21/2022
5:38:22 PM

Taxiway T3 AOA Serv. Road TRK PTZ Site0



00333

6/21/2022
5:38:22 PM

Taxiway T3 AOA Serv. Road TRK PTZ Site0



00334

6/21/2022
5:38:22 PM

Taxiway T3 AOA Serv. Road TRK PTZ Site0



00335

6/21/2022
5:38:22 PM

Taxiway T3 AOA Serv. Road TRK PTZ Site0



00336

6/21/2022
5:38:22 PM

Taxiway T3 AOA Serv. Road TRK PTZ Site0



00337

6/21/2022
5:38:22 PM

Taxiway T3 AOA Serv. Road TRK PTZ Site0



00338

6/21/2022
5:38:22 PM

Taxiway T3 AOA Serv. Road TRK PTZ Site0



00339

6/21/2022
5:38:22 PM

Taxiway T3 AOA Serv. Road TRK PTZ Site0



00340

6/21/2022
5:38:22 PM

Taxiway T3 AOA Serv. Road TRK PTZ Site0



00341

6/21/2022
5:38:22 PM

Taxiway T3 AOA Serv. Road TRK PTZ Site0



00342

6/21/2022
5:38:22 PM

Taxiway T3 AOA Serv. Road TRK PTZ Site0



00343

6/21/2022
5:38:22 PM

Taxiway T3 AOA Serv. Road TRK PTZ Site0



00344

6/21/2022
5:38:23 PM

Taxiway T3 AOA Serv. Road TRK PTZ Site0



00345

6/21/2022
5:38:23 PM

Taxiway T3 AOA Serv. Road TRK PTZ Site0



00346

6/21/2022
5:38:23 PM

Taxiway T3 AOA Serv. Road TRK PTZ Site0



00347

6/21/2022
5:38:23 PM

Taxiway T3 AOA Serv. Road TRK PTZ Site0



00348

6/21/2022
5:38:23 PM

Taxiway T3 AOA Serv. Road TRK PTZ Site0



00349

6/21/2022
5:38:23 PM

Taxiway T3 AOA Serv. Road TRK PTZ Site0



00350

6/21/2022
5:38:23 PM

Taxiway T3 AOA Serv. Road TRK PTZ Site0



00351

6/21/2022
5:38:23 PM

Taxiway T3 AOA Serv. Road TRK PTZ Site0



00352

6/21/2022
5:38:23 PM

Taxiway T3 AOA Serv. Road TRK PTZ Site0



00353

6/21/2022
5:38:23 PM

Taxiway T3 AOA Serv. Road TRK PTZ Site0



00354

6/21/2022
5:38:23 PM

Taxiway T3 AOA Serv. Road TRK PTZ Site0



00355

6/21/2022
5:38:23 PM

Taxiway T3 AOA Serv. Road TRK PTZ Site0



00356

6/21/2022
5:38:23 PM

Taxiway T3 AOA Serv. Road TRK PTZ Site0



00357

6/21/2022
5:38:23 PM

Taxiway T3 AOA Serv. Road TRK PTZ Site0



00358

6/21/2022
5:38:23 PM

Taxiway T3 AOA Serv. Road TRK PTZ Site0



00359

6/21/2022
5:38:24 PM

Taxiway T3 AOA Serv. Road TRK PTZ Site0



00360

6/21/2022
5:38:24 PM

Taxiway T3 AOA Serv. Road TRK PTZ Site0



00361

ATTACHMENT 7: "E SAT TRAIN GUIDEWAY" CAMERA IMAGE SEQUENCE

6/21/2022
5:37:51 PM

E SAT TRAIN GUIDEWAY- 15180



00752

6/21/2022
5:37:51 PM

E SAT TRAIN GUIDEWAY- 15180



00753

6/21/2022
5:37:51 PM

E SAT TRAIN GUIDEWAY- 15180



00754

6/21/2022
5:37:51 PM

E SAT TRAIN GUIDEWAY- 15180



00755

6/21/2022
5:37:51 PM

E SAT TRAIN GUIDEWAY- 15180



00756

6/21/2022
5:37:51 PM

E SAT TRAIN GUIDEWAY- 15180



00757

6/21/2022
5:37:51 PM

E SAT TRAIN GUIDEWAY- 15180



00758

6/21/2022
5:37:51 PM

E SAT TRAIN GUIDEWAY- 15180



00759

6/21/2022
5:37:52 PM

E SAT TRAIN GUIDEWAY- 15180



00760

6/21/2022
5:37:52 PM

E SAT TRAIN GUIDEWAY- 15180



00761

6/21/2022
5:37:52 PM

E SAT TRAIN GUIDEWAY- 15180



00762

6/21/2022
5:37:52 PM

E SAT TRAIN GUIDEWAY- 15180



00763

6/21/2022
5:37:52 PM

E SAT TRAIN GUIDEWAY- 15180



00764

6/21/2022
5:37:52 PM

E SAT TRAIN GUIDEWAY- 15180



00765

6/21/2022
5:37:52 PM

E SAT TRAIN GUIDEWAY- 15180



00766

6/21/2022
5:37:52 PM

E SAT TRAIN GUIDEWAY- 15180



00767

6/21/2022
5:37:52 PM

E SAT TRAIN GUIDEWAY- 15180



00768

6/21/2022
5:37:52 PM

E SAT TRAIN GUIDEWAY- 15180



00769

6/21/2022
5:37:52 PM

E SAT TRAIN GUIDEWAY- 15180



00770

6/21/2022
5:37:52 PM

E SAT TRAIN GUIDEWAY- 15180



00771

6/21/2022
5:37:52 PM

E SAT TRAIN GUIDEWAY- 15180



00772

6/21/2022
5:37:52 PM

E SAT TRAIN GUIDEWAY- 15180



00773

6/21/2022
5:37:52 PM

E SAT TRAIN GUIDEWAY- 15180



00774

6/21/2022
5:37:53 PM

E SAT TRAIN GUIDEWAY- 15180



00775

6/21/2022
5:37:53 PM

E SAT TRAIN GUIDEWAY- 15180



00776

6/21/2022
5:37:53 PM

E SAT TRAIN GUIDEWAY- 15180



00777

6/21/2022
5:37:53 PM

E SAT TRAIN GUIDEWAY- 15180



00778

6/21/2022
5:37:53 PM

E SAT TRAIN GUIDEWAY- 15180



00779

6/21/2022
5:37:53 PM

E SAT TRAIN GUIDEWAY- 15180



00780

6/21/2022
5:37:53 PM

E SAT TRAIN GUIDEWAY- 15180



00781

6/21/2022
5:37:53 PM

E SAT TRAIN GUIDEWAY- 15180



00782

6/21/2022
5:37:53 PM

E SAT TRAIN GUIDEWAY- 15180



00783

6/21/2022
5:37:53 PM

E SAT TRAIN GUIDEWAY- 15180



00784

6/21/2022
5:37:53 PM

E SAT TRAIN GUIDEWAY- 15180



00785

6/21/2022
5:37:53 PM

E SAT TRAIN GUIDEWAY- 15180



00786

6/21/2022
5:37:53 PM

E SAT TRAIN GUIDEWAY- 15180



00787

6/21/2022
5:37:53 PM

E SAT TRAIN GUIDEWAY- 15180



00788

6/21/2022
5:37:54 PM

E SAT TRAIN GUIDEWAY- 15180



00789

6/21/2022
5:37:54 PM

E SAT TRAIN GUIDEWAY- 15180



00790

6/21/2022
5:37:54 PM

E SAT TRAIN GUIDEWAY- 15180



00791

6/21/2022
5:37:54 PM

E SAT TRAIN GUIDEWAY- 15180



00792

6/21/2022
5:37:54 PM

E SAT TRAIN GUIDEWAY- 15180



00793

6/21/2022
5:37:54 PM

E SAT TRAIN GUIDEWAY- 15180



00794

6/21/2022
5:37:54 PM

E SAT TRAIN GUIDEWAY- 15180



00795

6/21/2022
5:37:54 PM

E SAT TRAIN GUIDEWAY- 15180



00796

6/21/2022
5:37:54 PM

E SAT TRAIN GUIDEWAY- 15180



00797

6/21/2022
5:37:54 PM

E SAT TRAIN GUIDEWAY- 15180



00798

6/21/2022
5:37:54 PM

E SAT TRAIN GUIDEWAY- 15180



00799

6/21/2022
5:37:54 PM

E SAT TRAIN GUIDEWAY- 15180



00800

6/21/2022
5:37:54 PM

E SAT TRAIN GUIDEWAY- 15180



00801

6/21/2022
5:37:54 PM

E SAT TRAIN GUIDEWAY- 15180



00802

6/21/2022
5:37:54 PM

E SAT TRAIN GUIDEWAY- 15180



00803

6/21/2022
5:37:55 PM

E SAT TRAIN GUIDEWAY- 15180



00804

6/21/2022
5:37:55 PM

E SAT TRAIN GUIDEWAY- 15180



00805

6/21/2022
5:37:55 PM

E SAT TRAIN GUIDEWAY- 15180



00806

6/21/2022
5:37:55 PM

E SAT TRAIN GUIDEWAY- 15180



00807

6/21/2022
5:37:55 PM

E SAT TRAIN GUIDEWAY- 15180



00808

6/21/2022
5:37:55 PM

E SAT TRAIN GUIDEWAY- 15180



00809

6/21/2022
5:37:55 PM

E SAT TRAIN GUIDEWAY- 15180



00810

6/21/2022
5:37:55 PM

E SAT TRAIN GUIDEWAY- 15180



00811

6/21/2022
5:37:55 PM

E SAT TRAIN GUIDEWAY- 15180



00812

6/21/2022
5:37:55 PM

E SAT TRAIN GUIDEWAY- 15180



00813

6/21/2022
5:37:55 PM

E SAT TRAIN GUIDEWAY- 15180



00814

6/21/2022
5:37:55 PM

E SAT TRAIN GUIDEWAY- 15180



00815

6/21/2022
5:37:55 PM

E SAT TRAIN GUIDEWAY- 15180



00816

6/21/2022
5:37:55 PM

E SAT TRAIN GUIDEWAY- 15180



00817

6/21/2022
5:37:55 PM

E SAT TRAIN GUIDEWAY- 15180



00818

6/21/2022
5:37:56 PM

E SAT TRAIN GUIDEWAY- 15180



00819

6/21/2022
5:37:56 PM

E SAT TRAIN GUIDEWAY- 15180



00820

6/21/2022
5:37:56 PM

E SAT TRAIN GUIDEWAY- 15180



00821

6/21/2022
5:37:56 PM

E SAT TRAIN GUIDEWAY- 15180



00822

6/21/2022
5:37:56 PM

E SAT TRAIN GUIDEWAY- 15180



00823

6/21/2022
5:37:56 PM

E SAT TRAIN GUIDEWAY- 15180



00824

6/21/2022
5:37:56 PM

E SAT TRAIN GUIDEWAY- 15180



00825

6/21/2022
5:37:56 PM

E SAT TRAIN GUIDEWAY- 15180



00826

6/21/2022
5:37:56 PM

E SAT TRAIN GUIDEWAY- 15180



00827

6/21/2022
5:37:56 PM

E SAT TRAIN GUIDEWAY- 15180



00828

6/21/2022
5:37:56 PM

E SAT TRAIN GUIDEWAY- 15180



00829

6/21/2022
5:37:56 PM

E SAT TRAIN GUIDEWAY- 15180



00830

6/21/2022
5:37:56 PM

E SAT TRAIN GUIDEWAY- 15180



00831

6/21/2022
5:37:56 PM

E SAT TRAIN GUIDEWAY- 15180



00832

6/21/2022
5:37:57 PM

E SAT TRAIN GUIDEWAY- 15180



00833

6/21/2022
5:37:57 PM

E SAT TRAIN GUIDEWAY- 15180



00834

6/21/2022
5:37:57 PM

E SAT TRAIN GUIDEWAY- 15180



00835

6/21/2022
5:37:57 PM

E SAT TRAIN GUIDEWAY- 15180



00836

6/21/2022
5:37:57 PM

E SAT TRAIN GUIDEWAY- 15180



00837

6/21/2022
5:37:57 PM

E SAT TRAIN GUIDEWAY- 15180



00838

6/21/2022
5:37:57 PM

E SAT TRAIN GUIDEWAY- 15180



00839

6/21/2022
5:37:57 PM

E SAT TRAIN GUIDEWAY- 15180



00840

6/21/2022
5:37:57 PM

E SAT TRAIN GUIDEWAY- 15180



00841

6/21/2022
5:37:57 PM

E SAT TRAIN GUIDEWAY- 15180



00842

6/21/2022
5:37:57 PM

E SAT TRAIN GUIDEWAY- 15180



00843

6/21/2022
5:37:57 PM

E SAT TRAIN GUIDEWAY- 15180



00844

6/21/2022
5:37:57 PM

E SAT TRAIN GUIDEWAY- 15180



00845

6/21/2022
5:37:58 PM

E SAT TRAIN GUIDEWAY- 15180



00846

6/21/2022
5:37:58 PM

E SAT TRAIN GUIDEWAY- 15180



00847

6/21/2022
5:37:58 PM

E SAT TRAIN GUIDEWAY- 15180



00848

6/21/2022
5:37:58 PM

E SAT TRAIN GUIDEWAY- 15180



00849

6/21/2022
5:37:58 PM

E SAT TRAIN GUIDEWAY- 15180



00850

6/21/2022
5:37:58 PM

E SAT TRAIN GUIDEWAY- 15180



00851

6/21/2022
5:37:58 PM

E SAT TRAIN GUIDEWAY- 15180



00852

6/21/2022
5:37:58 PM

E SAT TRAIN GUIDEWAY- 15180



00853

6/21/2022
5:37:58 PM

E SAT TRAIN GUIDEWAY- 15180



00854

6/21/2022
5:37:58 PM

E SAT TRAIN GUIDEWAY- 15180



00855

6/21/2022
5:37:58 PM

E SAT TRAIN GUIDEWAY- 15180



00856

6/21/2022
5:37:58 PM

E SAT TRAIN GUIDEWAY- 15180



00857

6/21/2022
5:37:58 PM

E SAT TRAIN GUIDEWAY- 15180



00858

6/21/2022
5:37:58 PM

E SAT TRAIN GUIDEWAY- 15180



00859

6/21/2022
5:37:58 PM

E SAT TRAIN GUIDEWAY- 15180



00860

6/21/2022
5:37:58 PM

E SAT TRAIN GUIDEWAY- 15180



00861

6/21/2022
5:37:59 PM

E SAT TRAIN GUIDEWAY- 15180



00862

6/21/2022
5:37:59 PM

E SAT TRAIN GUIDEWAY- 15180



00863

6/21/2022
5:37:59 PM

E SAT TRAIN GUIDEWAY- 15180



00864

6/21/2022
5:37:59 PM

E SAT TRAIN GUIDEWAY- 15180



00865

6/21/2022
5:37:59 PM

E SAT TRAIN GUIDEWAY- 15180



00866

6/21/2022
5:37:59 PM

E SAT TRAIN GUIDEWAY- 15180



00867

6/21/2022
5:37:59 PM

E SAT TRAIN GUIDEWAY- 15180



00868

6/21/2022
5:37:59 PM

E SAT TRAIN GUIDEWAY- 15180



00869

6/21/2022
5:37:59 PM

E SAT TRAIN GUIDEWAY- 15180



00870

6/21/2022
5:37:59 PM

E SAT TRAIN GUIDEWAY- 15180



00871

6/21/2022
5:37:59 PM

E SAT TRAIN GUIDEWAY- 15180



00872

6/21/2022
5:37:59 PM

E SAT TRAIN GUIDEWAY- 15180



00873

6/21/2022
5:38:00 PM

E SAT TRAIN GUIDEWAY- 15180



00874

6/21/2022
5:38:00 PM

E SAT TRAIN GUIDEWAY- 15180



00875

6/21/2022
5:38:00 PM

E SAT TRAIN GUIDEWAY- 15180



00876

6/21/2022
5:38:00 PM

E SAT TRAIN GUIDEWAY- 15180



00877

6/21/2022
5:38:00 PM

E SAT TRAIN GUIDEWAY- 15180



00878

6/21/2022
5:38:00 PM

E SAT TRAIN GUIDEWAY- 15180



00879

6/21/2022
5:38:00 PM

E SAT TRAIN GUIDEWAY- 15180



00880

6/21/2022
5:38:00 PM

E SAT TRAIN GUIDEWAY- 15180



00881

6/21/2022
5:38:00 PM

E SAT TRAIN GUIDEWAY- 15180



00882

6/21/2022
5:38:00 PM

E SAT TRAIN GUIDEWAY- 15180



00883

6/21/2022
5:38:00 PM

E SAT TRAIN GUIDEWAY- 15180



00884

6/21/2022
5:38:00 PM

E SAT TRAIN GUIDEWAY- 15180



00885

6/21/2022
5:38:00 PM

E SAT TRAIN GUIDEWAY- 15180



00886

6/21/2022
5:38:00 PM

E SAT TRAIN GUIDEWAY- 15180



00887

6/21/2022
5:38:00 PM

E SAT TRAIN GUIDEWAY- 15180



00888

6/21/2022
5:38:01 PM

E SAT TRAIN GUIDEWAY- 15180



00889

6/21/2022
5:38:01 PM

E SAT TRAIN GUIDEWAY- 15180



00890

6/21/2022
5:38:01 PM

E SAT TRAIN GUIDEWAY- 15180



00891

6/21/2022
5:38:01 PM

E SAT TRAIN GUIDEWAY- 15180



00892

6/21/2022
5:38:01 PM

E SAT TRAIN GUIDEWAY- 15180



00893

6/21/2022
5:38:01 PM

E SAT TRAIN GUIDEWAY- 15180



00894

6/21/2022
5:38:01 PM

E SAT TRAIN GUIDEWAY- 15180



00895

6/21/2022
5:38:01 PM

E SAT TRAIN GUIDEWAY- 15180



00896

6/21/2022
5:38:01 PM

E SAT TRAIN GUIDEWAY- 15180



00897

6/21/2022
5:38:01 PM

E SAT TRAIN GUIDEWAY- 15180



00898

6/21/2022
5:38:01 PM

E SAT TRAIN GUIDEWAY- 15180



00899

6/21/2022
5:38:01 PM

E SAT TRAIN GUIDEWAY- 15180



00900

6/21/2022
5:38:01 PM

E SAT TRAIN GUIDEWAY- 15180



00901

6/21/2022
5:38:01 PM

E SAT TRAIN GUIDEWAY- 15180



00902

6/21/2022
5:38:02 PM

E SAT TRAIN GUIDEWAY- 15180



00903

6/21/2022
5:38:02 PM

E SAT TRAIN GUIDEWAY- 15180



00904

6/21/2022
5:38:02 PM

E SAT TRAIN GUIDEWAY- 15180



00905

6/21/2022
5:38:02 PM

E SAT TRAIN GUIDEWAY- 15180



00906

6/21/2022
5:38:02 PM

E SAT TRAIN GUIDEWAY- 15180



00907

6/21/2022
5:38:02 PM

E SAT TRAIN GUIDEWAY- 15180



00908

6/21/2022
5:38:02 PM

E SAT TRAIN GUIDEWAY- 15180



00909

6/21/2022
5:38:02 PM

E SAT TRAIN GUIDEWAY- 15180



00910

6/21/2022
5:38:02 PM

E SAT TRAIN GUIDEWAY- 15180



00911

6/21/2022
5:38:02 PM

E SAT TRAIN GUIDEWAY- 15180



00912

6/21/2022
5:38:02 PM

E SAT TRAIN GUIDEWAY- 15180



00913

6/21/2022
5:38:02 PM

E SAT TRAIN GUIDEWAY- 15180



00914

6/21/2022
5:38:02 PM

E SAT TRAIN GUIDEWAY- 15180



00915

6/21/2022
5:38:02 PM

E SAT TRAIN GUIDEWAY- 15180



00916

6/21/2022
5:38:02 PM

E SAT TRAIN GUIDEWAY- 15180



00917

6/21/2022
5:38:03 PM

E SAT TRAIN GUIDEWAY- 15180



00918

6/21/2022
5:38:03 PM

E SAT TRAIN GUIDEWAY- 15180



00919

6/21/2022
5:38:03 PM

E SAT TRAIN GUIDEWAY- 15180



00920

6/21/2022
5:38:03 PM

E SAT TRAIN GUIDEWAY- 15180



00921

6/21/2022
5:38:03 PM

E SAT TRAIN GUIDEWAY- 15180



00922

6/21/2022
5:38:03 PM

E SAT TRAIN GUIDEWAY- 15180



00923

6/21/2022
5:38:03 PM

E SAT TRAIN GUIDEWAY- 15180



00924

6/21/2022
5:38:03 PM

E SAT TRAIN GUIDEWAY- 15180



00925

6/21/2022
5:38:03 PM

E SAT TRAIN GUIDEWAY- 15180



00926

6/21/2022
5:38:03 PM

E SAT TRAIN GUIDEWAY- 15180



00927

6/21/2022
5:38:03 PM

E SAT TRAIN GUIDEWAY- 15180



00928

6/21/2022
5:38:03 PM

E SAT TRAIN GUIDEWAY- 15180



00929

6/21/2022
5:38:03 PM

E SAT TRAIN GUIDEWAY- 15180



00930

6/21/2022
5:38:03 PM

E SAT TRAIN GUIDEWAY- 15180



00931

6/21/2022
5:38:03 PM

E SAT TRAIN GUIDEWAY- 15180



00932

6/21/2022
5:38:04 PM

E SAT TRAIN GUIDEWAY- 15180



00933

6/21/2022
5:38:04 PM

E SAT TRAIN GUIDEWAY- 15180



00934

6/21/2022
5:38:04 PM

E SAT TRAIN GUIDEWAY- 15180



00935

6/21/2022
5:38:04 PM

E SAT TRAIN GUIDEWAY- 15180



00936

6/21/2022
5:38:04 PM

E SAT TRAIN GUIDEWAY- 15180



00937

6/21/2022
5:38:04 PM

E SAT TRAIN GUIDEWAY- 15180



00938

6/21/2022
5:38:04 PM

E SAT TRAIN GUIDEWAY- 15180



00939

6/21/2022
5:38:04 PM

E SAT TRAIN GUIDEWAY- 15180



00940

6/21/2022
5:38:04 PM

E SAT TRAIN GUIDEWAY- 15180



00941

6/21/2022
5:38:04 PM

E SAT TRAIN GUIDEWAY- 15180



00942

6/21/2022
5:38:04 PM

E SAT TRAIN GUIDEWAY- 15180



00943

6/21/2022
5:38:04 PM

E SAT TRAIN GUIDEWAY- 15180



00944

6/21/2022
5:38:04 PM

E SAT TRAIN GUIDEWAY- 15180



00945

6/21/2022
5:38:04 PM

E SAT TRAIN GUIDEWAY- 15180



00946

6/21/2022
5:38:04 PM

E SAT TRAIN GUIDEWAY- 15180



00947

6/21/2022
5:38:05 PM

E SAT TRAIN GUIDEWAY- 15180



00948

6/21/2022
5:38:05 PM

E SAT TRAIN GUIDEWAY- 15180



00949

6/21/2022
5:38:05 PM

E SAT TRAIN GUIDEWAY- 15180



00950

6/21/2022
5:38:05 PM

E SAT TRAIN GUIDEWAY- 15180



00951

6/21/2022
5:38:05 PM

E SAT TRAIN GUIDEWAY- 15180



00952

6/21/2022
5:38:05 PM

E SAT TRAIN GUIDEWAY- 15180



00953

6/21/2022
5:38:05 PM

E SAT TRAIN GUIDEWAY- 15180



00954

6/21/2022
5:38:05 PM

E SAT TRAIN GUIDEWAY- 15180



00955

6/21/2022
5:38:05 PM

E SAT TRAIN GUIDEWAY- 15180



00956

6/21/2022
5:38:05 PM

E SAT TRAIN GUIDEWAY- 15180



00957

6/21/2022
5:38:05 PM

E SAT TRAIN GUIDEWAY- 15180



00958

6/21/2022
5:38:05 PM

E SAT TRAIN GUIDEWAY- 15180



00959

6/21/2022
5:38:05 PM

E SAT TRAIN GUIDEWAY- 15180



00960

6/21/2022
5:38:05 PM

E SAT TRAIN GUIDEWAY- 15180



00961

6/21/2022
5:38:05 PM

E SAT TRAIN GUIDEWAY- 15180



00962

6/21/2022
5:38:06 PM

E SAT TRAIN GUIDEWAY- 15180



00963

6/21/2022
5:38:06 PM

E SAT TRAIN GUIDEWAY- 15180



00964

6/21/2022
5:38:06 PM

E SAT TRAIN GUIDEWAY- 15180



00965

6/21/2022
5:38:06 PM

E SAT TRAIN GUIDEWAY- 15180



00966

6/21/2022
5:38:06 PM

E SAT TRAIN GUIDEWAY- 15180



00967

6/21/2022
5:38:06 PM

E SAT TRAIN GUIDEWAY- 15180



00968

6/21/2022
5:38:06 PM

E SAT TRAIN GUIDEWAY- 15180



00969

6/21/2022
5:38:06 PM

E SAT TRAIN GUIDEWAY- 15180



00970

6/21/2022
5:38:06 PM

E SAT TRAIN GUIDEWAY- 15180



00971

6/21/2022
5:38:06 PM

E SAT TRAIN GUIDEWAY- 15180



00972

6/21/2022
5:38:06 PM

E SAT TRAIN GUIDEWAY- 15180



00973

6/21/2022
5:38:06 PM

E SAT TRAIN GUIDEWAY- 15180



00974

6/21/2022
5:38:06 PM

E SAT TRAIN GUIDEWAY- 15180



00975

6/21/2022
5:38:06 PM

E SAT TRAIN GUIDEWAY- 15180



00976

6/21/2022
5:38:06 PM

E SAT TRAIN GUIDEWAY- 15180



00977

6/21/2022
5:38:07 PM

E SAT TRAIN GUIDEWAY- 15180



00978

6/21/2022
5:38:07 PM

E SAT TRAIN GUIDEWAY- 15180



00979

6/21/2022
5:38:07 PM

E SAT TRAIN GUIDEWAY- 15180



00980

6/21/2022
5:38:07 PM

E SAT TRAIN GUIDEWAY- 15180



00981

6/21/2022
5:38:07 PM

E SAT TRAIN GUIDEWAY- 15180



00982

6/21/2022
5:38:07 PM

E SAT TRAIN GUIDEWAY- 15180



00983

6/21/2022
5:38:07 PM

E SAT TRAIN GUIDEWAY- 15180



00984

6/21/2022
5:38:07 PM

E SAT TRAIN GUIDEWAY- 15180



00985

6/21/2022
5:38:07 PM

E SAT TRAIN GUIDEWAY- 15180



00986

6/21/2022
5:38:07 PM

E SAT TRAIN GUIDEWAY- 15180



00987

6/21/2022
5:38:07 PM

E SAT TRAIN GUIDEWAY- 15180



00988

6/21/2022
5:38:07 PM

E SAT TRAIN GUIDEWAY- 15180



00989

6/21/2022
5:38:08 PM

E SAT TRAIN GUIDEWAY- 15180



00990

6/21/2022
5:38:08 PM

E SAT TRAIN GUIDEWAY- 15180



00991

6/21/2022
5:38:08 PM

E SAT TRAIN GUIDEWAY- 15180



00992

6/21/2022
5:38:08 PM

E SAT TRAIN GUIDEWAY- 15180



00993

6/21/2022
5:38:08 PM

E SAT TRAIN GUIDEWAY- 15180



00994

6/21/2022
5:38:08 PM

E SAT TRAIN GUIDEWAY- 15180



00995

6/21/2022
5:38:08 PM

E SAT TRAIN GUIDEWAY- 15180



00996

6/21/2022
5:38:08 PM

E SAT TRAIN GUIDEWAY- 15180



00997

6/21/2022
5:38:08 PM

E SAT TRAIN GUIDEWAY- 15180



00998

6/21/2022
5:38:08 PM

E SAT TRAIN GUIDEWAY- 15180



00999

6/21/2022
5:38:08 PM

E SAT TRAIN GUIDEWAY- 15180



01000

6/21/2022
5:38:08 PM

E SAT TRAIN GUIDEWAY- 15180



01001

6/21/2022
5:38:08 PM

E SAT TRAIN GUIDEWAY- 15180



01002

6/21/2022
5:38:08 PM

E SAT TRAIN GUIDEWAY- 15180



01003

6/21/2022
5:38:08 PM

E SAT TRAIN GUIDEWAY- 15180



01004

6/21/2022
5:38:08 PM

E SAT TRAIN GUIDEWAY- 15180



01005

6/21/2022
5:38:09 PM

E SAT TRAIN GUIDEWAY- 15180



01006

6/21/2022
5:38:09 PM

E SAT TRAIN GUIDEWAY- 15180



01007

6/21/2022
5:38:09 PM

E SAT TRAIN GUIDEWAY- 15180



01008

6/21/2022
5:38:09 PM

E SAT TRAIN GUIDEWAY- 15180



01009

6/21/2022
5:38:09 PM

E SAT TRAIN GUIDEWAY- 15180



01010

6/21/2022
5:38:09 PM

E SAT TRAIN GUIDEWAY- 15180



01011

6/21/2022
5:38:09 PM

E SAT TRAIN GUIDEWAY- 15180



01012

6/21/2022
5:38:09 PM

E SAT TRAIN GUIDEWAY- 15180



01013

6/21/2022
5:38:09 PM

E SAT TRAIN GUIDEWAY- 15180



01014

6/21/2022
5:38:09 PM

E SAT TRAIN GUIDEWAY- 15180



01015

6/21/2022
5:38:09 PM

E SAT TRAIN GUIDEWAY- 15180



01016

6/21/2022
5:38:09 PM

E SAT TRAIN GUIDEWAY- 15180



01017

6/21/2022
5:38:09 PM

E SAT TRAIN GUIDEWAY- 15180



01018

6/21/2022
5:38:09 PM

E SAT TRAIN GUIDEWAY- 15180



01019

6/21/2022
5:38:10 PM

E SAT TRAIN GUIDEWAY- 15180



01020

6/21/2022
5:38:10 PM

E SAT TRAIN GUIDEWAY- 15180



01021

6/21/2022
5:38:10 PM

E SAT TRAIN GUIDEWAY- 15180



01022

6/21/2022
5:38:10 PM

E SAT TRAIN GUIDEWAY- 15180



01023

6/21/2022
5:38:10 PM

E SAT TRAIN GUIDEWAY- 15180



01024

6/21/2022
5:38:10 PM

E SAT TRAIN GUIDEWAY- 15180



01025

6/21/2022
5:38:10 PM

E SAT TRAIN GUIDEWAY- 15180



01026

6/21/2022
5:38:10 PM

E SAT TRAIN GUIDEWAY- 15180



01027

6/21/2022
5:38:10 PM

E SAT TRAIN GUIDEWAY- 15180



01028

6/21/2022
5:38:10 PM

E SAT TRAIN GUIDEWAY- 15180



01029

6/21/2022
5:38:10 PM

E SAT TRAIN GUIDEWAY- 15180



01030

6/21/2022
5:38:10 PM

E SAT TRAIN GUIDEWAY- 15180



01031

6/21/2022
5:38:10 PM

E SAT TRAIN GUIDEWAY- 15180



01032

6/21/2022
5:38:11 PM

E SAT TRAIN GUIDEWAY- 15180



01033

6/21/2022
5:38:11 PM

E SAT TRAIN GUIDEWAY- 15180



01034

6/21/2022
5:38:11 PM

E SAT TRAIN GUIDEWAY- 15180



01035

6/21/2022
5:38:11 PM

E SAT TRAIN GUIDEWAY- 15180



01036

6/21/2022
5:38:11 PM

E SAT TRAIN GUIDEWAY- 15180



01037

6/21/2022
5:38:11 PM

E SAT TRAIN GUIDEWAY- 15180



01038

6/21/2022
5:38:11 PM

E SAT TRAIN GUIDEWAY- 15180



01039

6/21/2022
5:38:11 PM

E SAT TRAIN GUIDEWAY- 15180



01040

6/21/2022
5:38:11 PM

E SAT TRAIN GUIDEWAY- 15180



01041

6/21/2022
5:38:11 PM

E SAT TRAIN GUIDEWAY- 15180



01042

6/21/2022
5:38:11 PM

E SAT TRAIN GUIDEWAY- 15180



01043

6/21/2022
5:38:11 PM

E SAT TRAIN GUIDEWAY- 15180



01044

6/21/2022
5:38:11 PM

E SAT TRAIN GUIDEWAY- 15180



01045

6/21/2022
5:38:12 PM

E SAT TRAIN GUIDEWAY- 15180



01046

6/21/2022
5:38:12 PM

E SAT TRAIN GUIDEWAY- 15180



01047

6/21/2022
5:38:12 PM

E SAT TRAIN GUIDEWAY- 15180



01048

6/21/2022
5:38:12 PM

E SAT TRAIN GUIDEWAY- 15180



01049

6/21/2022
5:38:12 PM

E SAT TRAIN GUIDEWAY- 15180



01050

6/21/2022
5:38:12 PM

E SAT TRAIN GUIDEWAY- 15180



01051

6/21/2022
5:38:12 PM

E SAT TRAIN GUIDEWAY- 15180



01052

6/21/2022
5:38:12 PM

E SAT TRAIN GUIDEWAY- 15180



01053

6/21/2022
5:38:12 PM

E SAT TRAIN GUIDEWAY- 15180



01054

6/21/2022
5:38:12 PM

E SAT TRAIN GUIDEWAY- 15180



01055

6/21/2022
5:38:12 PM

E SAT TRAIN GUIDEWAY- 15180



01056

6/21/2022
5:38:12 PM

E SAT TRAIN GUIDEWAY- 15180



01057

6/21/2022
5:38:12 PM

E SAT TRAIN GUIDEWAY- 15180



01058

6/21/2022
5:38:12 PM

E SAT TRAIN GUIDEWAY- 15180



01059

6/21/2022
5:38:12 PM

E SAT TRAIN GUIDEWAY- 15180



01060

6/21/2022
5:38:13 PM

E SAT TRAIN GUIDEWAY- 15180



01061

6/21/2022
5:38:13 PM

E SAT TRAIN GUIDEWAY- 15180



01062

6/21/2022
5:38:13 PM

E SAT TRAIN GUIDEWAY- 15180



01063

6/21/2022
5:38:13 PM

E SAT TRAIN GUIDEWAY- 15180



01064

6/21/2022
5:38:13 PM

E SAT TRAIN GUIDEWAY- 15180



01065

6/21/2022
5:38:13 PM

E SAT TRAIN GUIDEWAY- 15180



01066

6/21/2022
5:38:13 PM

E SAT TRAIN GUIDEWAY- 15180



01067

6/21/2022
5:38:13 PM

E SAT TRAIN GUIDEWAY- 15180



01068

6/21/2022
5:38:13 PM

E SAT TRAIN GUIDEWAY- 15180



01069

6/21/2022
5:38:13 PM

E SAT TRAIN GUIDEWAY- 15180



01070

6/21/2022
5:38:13 PM

E SAT TRAIN GUIDEWAY- 15180



01071

6/21/2022
5:38:13 PM

E SAT TRAIN GUIDEWAY- 15180



01072

6/21/2022
5:38:13 PM

E SAT TRAIN GUIDEWAY- 15180



01073

6/21/2022
5:38:13 PM

E SAT TRAIN GUIDEWAY- 15180



01074

6/21/2022
5:38:13 PM

E SAT TRAIN GUIDEWAY- 15180



01075

6/21/2022
5:38:14 PM

E SAT TRAIN GUIDEWAY- 15180



01076

6/21/2022
5:38:14 PM

E SAT TRAIN GUIDEWAY- 15180



01077

6/21/2022
5:38:14 PM

E SAT TRAIN GUIDEWAY- 15180



01078

6/21/2022
5:38:14 PM

E SAT TRAIN GUIDEWAY- 15180



01079

6/21/2022
5:38:14 PM

E SAT TRAIN GUIDEWAY- 15180



01080

6/21/2022
5:38:14 PM

E SAT TRAIN GUIDEWAY- 15180



01081

6/21/2022
5:38:14 PM

E SAT TRAIN GUIDEWAY- 15180



01082

6/21/2022
5:38:14 PM

E SAT TRAIN GUIDEWAY- 15180



01083

6/21/2022
5:38:14 PM

E SAT TRAIN GUIDEWAY- 15180



01084

6/21/2022
5:38:14 PM

E SAT TRAIN GUIDEWAY- 15180



01085

6/21/2022
5:38:14 PM

E SAT TRAIN GUIDEWAY- 15180



01086

6/21/2022
5:38:14 PM

E SAT TRAIN GUIDEWAY- 15180



01087

6/21/2022
5:38:14 PM

E SAT TRAIN GUIDEWAY- 15180



01088

6/21/2022
5:38:14 PM

E SAT TRAIN GUIDEWAY- 15180



01089

6/21/2022
5:38:15 PM

E SAT TRAIN GUIDEWAY- 15180



01090

6/21/2022
5:38:15 PM

E SAT TRAIN GUIDEWAY- 15180



01091

6/21/2022
5:38:15 PM

E SAT TRAIN GUIDEWAY- 15180



01092

6/21/2022
5:38:15 PM

E SAT TRAIN GUIDEWAY- 15180



01093

6/21/2022
5:38:15 PM

E SAT TRAIN GUIDEWAY- 15180



01094

6/21/2022
5:38:15 PM

E SAT TRAIN GUIDEWAY- 15180



01095

6/21/2022
5:38:15 PM

E SAT TRAIN GUIDEWAY- 15180



01096

6/21/2022
5:38:15 PM

E SAT TRAIN GUIDEWAY- 15180



01097

6/21/2022
5:38:15 PM

E SAT TRAIN GUIDEWAY- 15180



01098

6/21/2022
5:38:15 PM

E SAT TRAIN GUIDEWAY- 15180



01099

6/21/2022
5:38:15 PM

E SAT TRAIN GUIDEWAY- 15180



01100

6/21/2022
5:38:15 PM

E SAT TRAIN GUIDEWAY- 15180



01101

6/21/2022
5:38:15 PM

E SAT TRAIN GUIDEWAY- 15180



01102

6/21/2022
5:38:15 PM

E SAT TRAIN GUIDEWAY- 15180



01103

6/21/2022
5:38:15 PM

E SAT TRAIN GUIDEWAY- 15180



01104

6/21/2022
5:38:16 PM

E SAT TRAIN GUIDEWAY- 15180



01105

6/21/2022
5:38:16 PM

E SAT TRAIN GUIDEWAY- 15180



01106

6/21/2022
5:38:16 PM

E SAT TRAIN GUIDEWAY- 15180



01107

6/21/2022
5:38:16 PM

E SAT TRAIN GUIDEWAY- 15180



01108

6/21/2022
5:38:16 PM

E SAT TRAIN GUIDEWAY- 15180



01109

6/21/2022
5:38:16 PM

E SAT TRAIN GUIDEWAY- 15180



01110

6/21/2022
5:38:16 PM

E SAT TRAIN GUIDEWAY- 15180



01111

6/21/2022
5:38:16 PM

E SAT TRAIN GUIDEWAY- 15180



01112

6/21/2022
5:38:16 PM

E SAT TRAIN GUIDEWAY- 15180



01113

6/21/2022
5:38:16 PM

E SAT TRAIN GUIDEWAY- 15180



01114

6/21/2022
5:38:16 PM

E SAT TRAIN GUIDEWAY- 15180



01115

6/21/2022
5:38:16 PM

E SAT TRAIN GUIDEWAY- 15180



01116

6/21/2022
5:38:16 PM

E SAT TRAIN GUIDEWAY- 15180



01117

6/21/2022
5:38:16 PM

E SAT TRAIN GUIDEWAY- 15180



01118

6/21/2022
5:38:16 PM

E SAT TRAIN GUIDEWAY- 15180



01119

6/21/2022
5:38:17 PM

E SAT TRAIN GUIDEWAY- 15180



01120

6/21/2022
5:38:17 PM

E SAT TRAIN GUIDEWAY- 15180



01121

6/21/2022
5:38:17 PM

E SAT TRAIN GUIDEWAY- 15180



01122

6/21/2022
5:38:17 PM

E SAT TRAIN GUIDEWAY- 15180



01123

6/21/2022
5:38:17 PM

E SAT TRAIN GUIDEWAY- 15180



01124

6/21/2022
5:38:17 PM

E SAT TRAIN GUIDEWAY- 15180



01125

6/21/2022
5:38:17 PM

E SAT TRAIN GUIDEWAY- 15180



01126

6/21/2022
5:38:17 PM

E SAT TRAIN GUIDEWAY- 15180



01127

6/21/2022
5:38:17 PM

E SAT TRAIN GUIDEWAY- 15180



01128

6/21/2022
5:38:17 PM

E SAT TRAIN GUIDEWAY- 15180



01129

6/21/2022
5:38:17 PM

E SAT TRAIN GUIDEWAY- 15180



01130

6/21/2022
5:38:17 PM

E SAT TRAIN GUIDEWAY- 15180



01131

6/21/2022
5:38:17 PM

E SAT TRAIN GUIDEWAY- 15180



01132

6/21/2022
5:38:17 PM

E SAT TRAIN GUIDEWAY- 15180



01133

6/21/2022
5:38:17 PM

E SAT TRAIN GUIDEWAY- 15180



01134

6/21/2022
5:38:18 PM

E SAT TRAIN GUIDEWAY- 15180



01135

6/21/2022
5:38:18 PM

E SAT TRAIN GUIDEWAY- 15180



01136

6/21/2022
5:38:18 PM

E SAT TRAIN GUIDEWAY- 15180



01137

6/21/2022
5:38:18 PM

E SAT TRAIN GUIDEWAY- 15180



01138

6/21/2022
5:38:18 PM

E SAT TRAIN GUIDEWAY- 15180



01139

6/21/2022
5:38:18 PM

E SAT TRAIN GUIDEWAY- 15180



01140

6/21/2022
5:38:18 PM

E SAT TRAIN GUIDEWAY- 15180



01141

6/21/2022
5:38:18 PM

E SAT TRAIN GUIDEWAY- 15180



01142

6/21/2022
5:38:18 PM

E SAT TRAIN GUIDEWAY- 15180



01143

6/21/2022
5:38:18 PM

E SAT TRAIN GUIDEWAY- 15180



01144

6/21/2022
5:38:18 PM

E SAT TRAIN GUIDEWAY- 15180



01145

6/21/2022
5:38:18 PM

E SAT TRAIN GUIDEWAY- 15180



01146

6/21/2022
5:38:18 PM

E SAT TRAIN GUIDEWAY- 15180



01147

6/21/2022
5:38:18 PM

E SAT TRAIN GUIDEWAY- 15180



01148

6/21/2022
5:38:18 PM

E SAT TRAIN GUIDEWAY- 15180



01149

6/21/2022
5:38:19 PM

E SAT TRAIN GUIDEWAY- 15180



01150

6/21/2022
5:38:19 PM

E SAT TRAIN GUIDEWAY- 15180



01151

6/21/2022
5:38:19 PM

E SAT TRAIN GUIDEWAY- 15180



01152

6/21/2022
5:38:19 PM

E SAT TRAIN GUIDEWAY- 15180



01153

6/21/2022
5:38:19 PM

E SAT TRAIN GUIDEWAY- 15180



01154

6/21/2022
5:38:19 PM

E SAT TRAIN GUIDEWAY- 15180



01155

6/21/2022
5:38:19 PM

E SAT TRAIN GUIDEWAY- 15180



01156

6/21/2022
5:38:19 PM

E SAT TRAIN GUIDEWAY- 15180



01157

6/21/2022
5:38:19 PM

E SAT TRAIN GUIDEWAY- 15180



01158

6/21/2022
5:38:19 PM

E SAT TRAIN GUIDEWAY- 15180



01159

6/21/2022
5:38:19 PM

E SAT TRAIN GUIDEWAY- 15180



01160

6/21/2022
5:38:19 PM

E SAT TRAIN GUIDEWAY- 15180



01161

6/21/2022
5:38:19 PM

E SAT TRAIN GUIDEWAY- 15180



01162

6/21/2022
5:38:19 PM

E SAT TRAIN GUIDEWAY- 15180



01163

6/21/2022
5:38:19 PM

E SAT TRAIN GUIDEWAY- 15180



01164

6/21/2022
5:38:20 PM

E SAT TRAIN GUIDEWAY- 15180



01165

6/21/2022
5:38:20 PM

E SAT TRAIN GUIDEWAY- 15180



01166

6/21/2022
5:38:20 PM

E SAT TRAIN GUIDEWAY- 15180



01167

6/21/2022
5:38:20 PM

E SAT TRAIN GUIDEWAY- 15180



01168

6/21/2022
5:38:20 PM

E SAT TRAIN GUIDEWAY- 15180



01169

6/21/2022
5:38:20 PM

E SAT TRAIN GUIDEWAY- 15180



01170

6/21/2022
5:38:20 PM

E SAT TRAIN GUIDEWAY- 15180



01171

6/21/2022
5:38:20 PM

E SAT TRAIN GUIDEWAY- 15180



01172

6/21/2022
5:38:20 PM

E SAT TRAIN GUIDEWAY- 15180



01173

6/21/2022
5:38:20 PM

E SAT TRAIN GUIDEWAY- 15180



01174

6/21/2022
5:38:20 PM

E SAT TRAIN GUIDEWAY- 15180



01175

6/21/2022
5:38:20 PM

E SAT TRAIN GUIDEWAY- 15180



01176

6/21/2022
5:38:20 PM

E SAT TRAIN GUIDEWAY- 15180



01177

6/21/2022
5:38:20 PM

E SAT TRAIN GUIDEWAY- 15180



01178

6/21/2022
5:38:20 PM

E SAT TRAIN GUIDEWAY- 15180



01179

6/21/2022
5:38:21 PM

E SAT TRAIN GUIDEWAY- 15180



01180

6/21/2022
5:38:21 PM

E SAT TRAIN GUIDEWAY- 15180



01181

6/21/2022
5:38:21 PM

E SAT TRAIN GUIDEWAY- 15180



01182

6/21/2022
5:38:21 PM

E SAT TRAIN GUIDEWAY- 15180



01183

6/21/2022
5:38:21 PM

E SAT TRAIN GUIDEWAY- 15180



01184

6/21/2022
5:38:21 PM

E SAT TRAIN GUIDEWAY- 15180



01185

6/21/2022
5:38:21 PM

E SAT TRAIN GUIDEWAY- 15180



01186

6/21/2022
5:38:21 PM

E SAT TRAIN GUIDEWAY- 15180



01187

6/21/2022
5:38:21 PM

E SAT TRAIN GUIDEWAY- 15180



01188

6/21/2022
5:38:21 PM

E SAT TRAIN GUIDEWAY- 15180



01189

6/21/2022
5:38:21 PM

E SAT TRAIN GUIDEWAY- 15180



01190

6/21/2022
5:38:21 PM

E SAT TRAIN GUIDEWAY- 15180



01191

6/21/2022
5:38:21 PM

E SAT TRAIN GUIDEWAY- 15180



01192

6/21/2022
5:38:21 PM

E SAT TRAIN GUIDEWAY- 15180



01193

6/21/2022
5:38:22 PM

E SAT TRAIN GUIDEWAY- 15180



01194

6/21/2022
5:38:22 PM

E SAT TRAIN GUIDEWAY- 15180



01195

6/21/2022
5:38:22 PM

E SAT TRAIN GUIDEWAY- 15180



01196

6/21/2022
5:38:22 PM

E SAT TRAIN GUIDEWAY- 15180



01197

6/21/2022
5:38:22 PM

E SAT TRAIN GUIDEWAY- 15180



01198

6/21/2022
5:38:22 PM

E SAT TRAIN GUIDEWAY- 15180



01199

6/21/2022
5:38:22 PM

E SAT TRAIN GUIDEWAY- 15180



01200

6/21/2022
5:38:22 PM

E SAT TRAIN GUIDEWAY- 15180



01201

6/21/2022
5:38:22 PM

E SAT TRAIN GUIDEWAY- 15180



01202

6/21/2022
5:38:22 PM

E SAT TRAIN GUIDEWAY- 15180



01203

6/21/2022
5:38:22 PM

E SAT TRAIN GUIDEWAY- 15180



01204

6/21/2022
5:38:22 PM

E SAT TRAIN GUIDEWAY- 15180



01205

6/21/2022
5:38:22 PM

E SAT TRAIN GUIDEWAY- 15180



01206

6/21/2022
5:38:22 PM

E SAT TRAIN GUIDEWAY- 15180



01207

6/21/2022
5:38:22 PM

E SAT TRAIN GUIDEWAY- 15180



01208

6/21/2022
5:38:23 PM

E SAT TRAIN GUIDEWAY- 15180



01209

6/21/2022
5:38:23 PM

E SAT TRAIN GUIDEWAY- 15180



01210

6/21/2022
5:38:23 PM

E SAT TRAIN GUIDEWAY- 15180



01211

6/21/2022
5:38:23 PM

E SAT TRAIN GUIDEWAY- 15180



01212

6/21/2022
5:38:23 PM

E SAT TRAIN GUIDEWAY- 15180



01213

6/21/2022
5:38:23 PM

E SAT TRAIN GUIDEWAY- 15180



01214

6/21/2022
5:38:23 PM

E SAT TRAIN GUIDEWAY- 15180



01215

6/21/2022
5:38:23 PM

E SAT TRAIN GUIDEWAY- 15180



01216

6/21/2022
5:38:23 PM

E SAT TRAIN GUIDEWAY- 15180



01217

6/21/2022
5:38:23 PM

E SAT TRAIN GUIDEWAY- 15180



01218

6/21/2022
5:38:23 PM

E SAT TRAIN GUIDEWAY- 15180



01219

6/21/2022
5:38:23 PM

E SAT TRAIN GUIDEWAY- 15180



01220

6/21/2022
5:38:23 PM

E SAT TRAIN GUIDEWAY- 15180



01221

6/21/2022
5:38:23 PM

E SAT TRAIN GUIDEWAY- 15180



01222

6/21/2022
5:38:24 PM

E SAT TRAIN GUIDEWAY- 15180



01223

6/21/2022
5:38:24 PM

E SAT TRAIN GUIDEWAY- 15180



01224

6/21/2022
5:38:24 PM

E SAT TRAIN GUIDEWAY- 15180



01225

6/21/2022
5:38:24 PM

E SAT TRAIN GUIDEWAY- 15180



01226

6/21/2022
5:38:24 PM

E SAT TRAIN GUIDEWAY- 15180



01227

6/21/2022
5:38:24 PM

E SAT TRAIN GUIDEWAY- 15180



01228

6/21/2022
5:38:24 PM

E SAT TRAIN GUIDEWAY- 15180



01229

6/21/2022
5:38:24 PM

E SAT TRAIN GUIDEWAY- 15180



01230

6/21/2022
5:38:24 PM

E SAT TRAIN GUIDEWAY- 15180



01231

6/21/2022
5:38:24 PM

E SAT TRAIN GUIDEWAY- 15180



01232

6/21/2022
5:38:24 PM

E SAT TRAIN GUIDEWAY- 15180



01233

6/21/2022
5:38:24 PM

E SAT TRAIN GUIDEWAY- 15180



01234

6/21/2022
5:38:24 PM

E SAT TRAIN GUIDEWAY- 15180



01235

6/21/2022
5:38:24 PM

E SAT TRAIN GUIDEWAY- 15180



01236

6/21/2022
5:38:24 PM

E SAT TRAIN GUIDEWAY- 15180



01237

6/21/2022
5:38:25 PM

E SAT TRAIN GUIDEWAY- 15180



01238

6/21/2022
5:38:25 PM

E SAT TRAIN GUIDEWAY- 15180



01239

6/21/2022
5:38:25 PM

E SAT TRAIN GUIDEWAY- 15180



01240

6/21/2022
5:38:25 PM

E SAT TRAIN GUIDEWAY- 15180



01241

6/21/2022
5:38:25 PM

E SAT TRAIN GUIDEWAY- 15180



01242

6/21/2022
5:38:25 PM

E SAT TRAIN GUIDEWAY- 15180



01243

6/21/2022
5:38:25 PM

E SAT TRAIN GUIDEWAY- 15180



01244

6/21/2022
5:38:25 PM

E SAT TRAIN GUIDEWAY- 15180



01245

6/21/2022
5:38:25 PM

E SAT TRAIN GUIDEWAY- 15180



01246

6/21/2022
5:38:25 PM

E SAT TRAIN GUIDEWAY- 15180



01247

6/21/2022
5:38:25 PM

E SAT TRAIN GUIDEWAY- 15180



01248

6/21/2022
5:38:25 PM

E SAT TRAIN GUIDEWAY- 15180



01249

6/21/2022
5:38:25 PM

E SAT TRAIN GUIDEWAY- 15180



01250

6/21/2022
5:38:25 PM

E SAT TRAIN GUIDEWAY- 15180



01251

6/21/2022
5:38:25 PM

E SAT TRAIN GUIDEWAY- 15180



01252

6/21/2022
5:38:26 PM

E SAT TRAIN GUIDEWAY- 15180



01253

6/21/2022
5:38:26 PM

E SAT TRAIN GUIDEWAY- 15180



01254

6/21/2022
5:38:26 PM

E SAT TRAIN GUIDEWAY- 15180



01255

6/21/2022
5:38:26 PM

E SAT TRAIN GUIDEWAY- 15180



01256

6/21/2022
5:38:26 PM

E SAT TRAIN GUIDEWAY- 15180



01257

6/21/2022
5:38:26 PM

E SAT TRAIN GUIDEWAY- 15180



01258

6/21/2022
5:38:26 PM

E SAT TRAIN GUIDEWAY- 15180



01259

6/21/2022
5:38:26 PM

E SAT TRAIN GUIDEWAY- 15180



01260

6/21/2022
5:38:26 PM

E SAT TRAIN GUIDEWAY- 15180



01261

6/21/2022
5:38:26 PM

E SAT TRAIN GUIDEWAY- 15180



01262

6/21/2022
5:38:26 PM

E SAT TRAIN GUIDEWAY- 15180



01263

6/21/2022
5:38:26 PM

E SAT TRAIN GUIDEWAY- 15180



01264

6/21/2022
5:38:26 PM

E SAT TRAIN GUIDEWAY- 15180



01265

6/21/2022
5:38:26 PM

E SAT TRAIN GUIDEWAY- 15180



01266

6/21/2022
5:38:26 PM

E SAT TRAIN GUIDEWAY- 15180



01267

6/21/2022
5:38:27 PM

E SAT TRAIN GUIDEWAY- 15180



01268

6/21/2022
5:38:27 PM

E SAT TRAIN GUIDEWAY- 15180



01269

6/21/2022
5:38:27 PM

E SAT TRAIN GUIDEWAY- 15180



01270

6/21/2022
5:38:27 PM

E SAT TRAIN GUIDEWAY- 15180



01271

6/21/2022
5:38:27 PM

E SAT TRAIN GUIDEWAY- 15180



01272

6/21/2022
5:38:27 PM

E SAT TRAIN GUIDEWAY- 15180



01273

6/21/2022
5:38:27 PM

E SAT TRAIN GUIDEWAY- 15180



01274

6/21/2022
5:38:27 PM

E SAT TRAIN GUIDEWAY- 15180



01275

6/21/2022
5:38:27 PM

E SAT TRAIN GUIDEWAY- 15180



01276

6/21/2022
5:38:27 PM

E SAT TRAIN GUIDEWAY- 15180



01277

6/21/2022
5:38:27 PM

E SAT TRAIN GUIDEWAY- 15180



01278

6/21/2022
5:38:27 PM

E SAT TRAIN GUIDEWAY- 15180



01279

6/21/2022
5:38:27 PM

E SAT TRAIN GUIDEWAY- 15180



01280

6/21/2022
5:38:27 PM

E SAT TRAIN GUIDEWAY- 15180



01281

6/21/2022
5:38:27 PM

E SAT TRAIN GUIDEWAY- 15180



01282

6/21/2022
5:38:28 PM

E SAT TRAIN GUIDEWAY- 15180



01283

6/21/2022
5:38:28 PM

E SAT TRAIN GUIDEWAY- 15180



01284

6/21/2022
5:38:28 PM

E SAT TRAIN GUIDEWAY- 15180



01285

6/21/2022
5:38:28 PM

E SAT TRAIN GUIDEWAY- 15180



01286

6/21/2022
5:38:28 PM

E SAT TRAIN GUIDEWAY- 15180



01287

6/21/2022
5:38:28 PM

E SAT TRAIN GUIDEWAY- 15180



01288

6/21/2022
5:38:28 PM

E SAT TRAIN GUIDEWAY- 15180



01289

6/21/2022
5:38:28 PM

E SAT TRAIN GUIDEWAY- 15180



01290

6/21/2022
5:38:28 PM

E SAT TRAIN GUIDEWAY- 15180



01291

6/21/2022
5:38:28 PM

E SAT TRAIN GUIDEWAY- 15180



01292

6/21/2022
5:38:28 PM

E SAT TRAIN GUIDEWAY- 15180



01293

6/21/2022
5:38:28 PM

E SAT TRAIN GUIDEWAY- 15180



01294

6/21/2022
5:38:28 PM

E SAT TRAIN GUIDEWAY- 15180



01295

6/21/2022
5:38:28 PM

E SAT TRAIN GUIDEWAY- 15180



01296

6/21/2022
5:38:28 PM

E SAT TRAIN GUIDEWAY- 15180



01297

6/21/2022
5:38:29 PM

E SAT TRAIN GUIDEWAY- 15180



01298

6/21/2022
5:38:29 PM

E SAT TRAIN GUIDEWAY- 15180



01299

6/21/2022
5:38:29 PM

E SAT TRAIN GUIDEWAY- 15180



01300

6/21/2022
5:38:29 PM

E SAT TRAIN GUIDEWAY- 15180



01301

ATTACHMENT 8: "FAA TOWER AOA TRK PTZ 3 W" CAMERA
IMAGE SEQUENCE

6/21/2022
5:37:59 PM

FAA Tower AOA TRK PTZ #3 W- 16752



00082

6/21/2022
5:37:59 PM

FAA Tower AOA TRK PTZ #3 W- 16752



00083

6/21/2022
5:37:59 PM

FAA Tower AOA TRK PTZ #3 W- 16752



00084

6/21/2022
5:37:59 PM

FAA Tower AOA TRK PTZ #3 W- 16752



00085

6/21/2022
5:37:59 PM

FAA Tower AOA TRK PTZ #3 W- 16752



00086

6/21/2022
5:38:00 PM

FAA Tower AOA TRK PTZ #3 W- 16752



00087

6/21/2022
5:38:00 PM

FAA Tower AOA TRK PTZ #3 W- 16752



00088

6/21/2022
5:38:00 PM

FAA Tower AOA TRK PTZ #3 W- 16752



00089

6/21/2022
5:38:00 PM

FAA Tower AOA TRK PTZ #3 W- 16752



00090

6/21/2022
5:38:00 PM

FAA Tower AOA TRK PTZ #3 W- 16752



00091

6/21/2022
5:38:00 PM

FAA Tower AOA TRK PTZ #3 W- 16752



00092

6/21/2022
5:38:00 PM

FAA Tower AOA TRK PTZ #3 W- 16752



00093

6/21/2022
5:38:01 PM

FAA Tower AOA TRK PTZ #3 W- 16752



00094

6/21/2022
5:38:01 PM

FAA Tower AOA TRK PTZ #3 W- 16752



00095

6/21/2022
5:38:01 PM

FAA Tower AOA TRK PTZ #3 W- 16752



00096

6/21/2022
5:38:01 PM

FAA Tower AOA TRK PTZ #3 W- 16752



00097

6/21/2022
5:38:01 PM

FAA Tower AOA TRK PTZ #3 W- 16752



00098

6/21/2022
5:38:01 PM

FAA Tower AOA TRK PTZ #3 W- 16752



00099

6/21/2022
5:38:01 PM

FAA Tower AOA TRK PTZ #3 W- 16752



00100

6/21/2022
5:38:01 PM

FAA Tower AOA TRK PTZ #3 W- 16752



00101

6/21/2022
5:38:01 PM

FAA Tower AOA TRK PTZ #3 W- 16752



00102

6/21/2022
5:38:02 PM

FAA Tower AOA TRK PTZ #3 W- 16752



00103

6/21/2022
5:38:02 PM

FAA Tower AOA TRK PTZ #3 W- 16752



00104

6/21/2022
5:38:02 PM

FAA Tower AOA TRK PTZ #3 W- 16752



00105

6/21/2022
5:38:02 PM

FAA Tower AOA TRK PTZ #3 W- 16752



00106

6/21/2022
5:38:02 PM

FAA Tower AOA TRK PTZ #3 W- 16752



00107

6/21/2022
5:38:02 PM

FAA Tower AOA TRK PTZ #3 W- 16752



00108

6/21/2022
5:38:02 PM

FAA Tower AOA TRK PTZ #3 W- 16752



00109

6/21/2022
5:38:02 PM

FAA Tower AOA TRK PTZ #3 W- 16752



00110

6/21/2022
5:38:03 PM

FAA Tower AOA TRK PTZ #3 W- 16752



00111

6/21/2022
5:38:03 PM

FAA Tower AOA TRK PTZ #3 W- 16752



00112

6/21/2022
5:38:03 PM

FAA Tower AOA TRK PTZ #3 W- 16752



00113

6/21/2022
5:38:03 PM

FAA Tower AOA TRK PTZ #3 W- 16752



00114

6/21/2022
5:38:03 PM

FAA Tower AOA TRK PTZ #3 W- 16752



00115

6/21/2022
5:38:03 PM

FAA Tower AOA TRK PTZ #3 W- 16752



00116

6/21/2022
5:38:03 PM

FAA Tower AOA TRK PTZ #3 W- 16752



00117

6/21/2022
5:38:03 PM

FAA Tower AOA TRK PTZ #3 W- 16752



00118

6/21/2022
5:38:03 PM

FAA Tower AOA TRK PTZ #3 W- 16752



00119

6/21/2022
5:38:04 PM

FAA Tower AOA TRK PTZ #3 W- 16752



00120

6/21/2022
5:38:04 PM

FAA Tower AOA TRK PTZ #3 W- 16752



00121

6/21/2022
5:38:04 PM

FAA Tower AOA TRK PTZ #3 W- 16752



00122

6/21/2022
5:38:04 PM

FAA Tower AOA TRK PTZ #3 W- 16752



00123

6/21/2022
5:38:04 PM

FAA Tower AOA TRK PTZ #3 W- 16752



00124

6/21/2022
5:38:04 PM

FAA Tower AOA TRK PTZ #3 W- 16752



00125

6/21/2022
5:38:04 PM

FAA Tower AOA TRK PTZ #3 W- 16752



00126

6/21/2022
5:38:04 PM

FAA Tower AOA TRK PTZ #3 W- 16752



00127

6/21/2022
5:38:05 PM

FAA Tower AOA TRK PTZ #3 W- 16752



00128

6/21/2022
5:38:05 PM

FAA Tower AOA TRK PTZ #3 W- 16752



00129

6/21/2022
5:38:05 PM

FAA Tower AOA TRK PTZ #3 W- 16752



00130

6/21/2022
5:38:05 PM

FAA Tower AOA TRK PTZ #3 W- 16752



00131

6/21/2022
5:38:05 PM

FAA Tower AOA TRK PTZ #3 W- 16752



00132

6/21/2022
5:38:05 PM

FAA Tower AOA TRK PTZ #3 W- 16752



00133

6/21/2022
5:38:05 PM

FAA Tower AOA TRK PTZ #3 W- 16752



00134

6/21/2022
5:38:05 PM

FAA Tower AOA TRK PTZ #3 W- 16752



00135

6/21/2022
5:38:06 PM

FAA Tower AOA TRK PTZ #3 W- 16752



00136

6/21/2022
5:38:06 PM

FAA Tower AOA TRK PTZ #3 W- 16752



00137

6/21/2022
5:38:06 PM

FAA Tower AOA TRK PTZ #3 W- 16752



00138

6/21/2022
5:38:06 PM

FAA Tower AOA TRK PTZ #3 W- 16752



00139

6/21/2022
5:38:06 PM

FAA Tower AOA TRK PTZ #3 W- 16752



00140

6/21/2022
5:38:06 PM

FAA Tower AOA TRK PTZ #3 W- 16752



00141

6/21/2022
5:38:06 PM

FAA Tower AOA TRK PTZ #3 W- 16752



00142

6/21/2022
5:38:06 PM

FAA Tower AOA TRK PTZ #3 W- 16752



00143

6/21/2022
5:38:07 PM

FAA Tower AOA TRK PTZ #3 W- 16752



00144

6/21/2022
5:38:07 PM

FAA Tower AOA TRK PTZ #3 W- 16752



00145

6/21/2022
5:38:07 PM

FAA Tower AOA TRK PTZ #3 W- 16752



00146

6/21/2022
5:38:07 PM

FAA Tower AOA TRK PTZ #3 W- 16752



00147

6/21/2022
5:38:07 PM

FAA Tower AOA TRK PTZ #3 W- 16752



00148

6/21/2022
5:38:07 PM

FAA Tower AOA TRK PTZ #3 W- 16752



00149

6/21/2022
5:38:07 PM

FAA Tower AOA TRK PTZ #3 W- 16752



00150

6/21/2022
5:38:07 PM

FAA Tower AOA TRK PTZ #3 W- 16752



00151

6/21/2022
5:38:08 PM

FAA Tower AOA TRK PTZ #3 W- 16752



00152

6/21/2022
5:38:08 PM

FAA Tower AOA TRK PTZ #3 W- 16752



00153

6/21/2022
5:38:08 PM

FAA Tower AOA TRK PTZ #3 W- 16752



00154

6/21/2022
5:38:08 PM

FAA Tower AOA TRK PTZ #3 W- 16752



00155

6/21/2022
5:38:08 PM

FAA Tower AOA TRK PTZ #3 W- 16752



00156

6/21/2022
5:38:08 PM

FAA Tower AOA TRK PTZ #3 W- 16752



00157

6/21/2022
5:38:09 PM

FAA Tower AOA TRK PTZ #3 W- 16752



00158

6/21/2022
5:38:09 PM

FAA Tower AOA TRK PTZ #3 W- 16752



00159

6/21/2022
5:38:09 PM

FAA Tower AOA TRK PTZ #3 W- 16752



00160

6/21/2022
5:38:09 PM

FAA Tower AOA TRK PTZ #3 W- 16752



00161

6/21/2022
5:38:09 PM

FAA Tower AOA TRK PTZ #3 W- 16752



00162

6/21/2022
5:38:09 PM

FAA Tower AOA TRK PTZ #3 W- 16752



00163

ATTACHMENT 9: "FAA TOWER AOA TRK PTZ 2 S" CAMERA
IMAGE SEQUENCE

8/21/2022
5:38:28 PM



00072

8/21/2022
5:38:28 PM



00073

8/21/2022
5:38:28 PM



00074

8/21/2022
5:38:29 PM



00075

6/21/2022
5:38:29 PM



00076

6/21/2022
5:38:29 PM



00077

6/21/2022
5:38:29 PM



00078

6/21/2022
5:38:29 PM



00079

8/21/2022
5:38:29 PM



00080

8/21/2022
5:38:29 PM



00081

6/21/2022
5:38:30 PM



00082

6/21/2022
5:38:30 PM



00083

6/21/2022
5:38:30 PM



00084

6/21/2022
5:38:30 PM



00085

8/21/2022
5:38:30 PM



00086

8/21/2022
5:38:30 PM



00087

8/21/2022
5:38:30 PM



00088

8/21/2022
5:38:30 PM



00089

8/21/2022
5:38:30 PM



00090

8/21/2022
5:38:31 PM



00091

6/21/2022
5:38:31 PM



00092

6/21/2022
5:38:31 PM



00093

6/21/2022
5:38:31 PM



00094

6/21/2022
5:38:31 PM



00095

8/21/2022
5:38:31 PM



00096

8/21/2022
5:38:31 PM



00097

6/21/2022
5:38:31 PM



00098

6/21/2022
5:38:32 PM



00099

6/21/2022
5:38:32 PM



00100

6/21/2022
5:38:32 PM



00101

6/21/2022
5:38:32 PM



00102

6/21/2022
5:38:32 PM



00103

6/21/2022
5:38:32 PM



00104

6/21/2022
5:38:32 PM



00105

8/21/2022
5:38:32 PM



00106

8/21/2022
5:38:32 PM



00107

6/21/2022
5:38:33 PM



00108

6/21/2022
5:38:33 PM



00109

6/21/2022
5:38:33 PM



00110

6/21/2022
5:38:33 PM



00111

6/21/2022
5:38:33 PM



00112

6/21/2022
5:38:33 PM



00113

6/21/2022
5:38:33 PM



00114

6/21/2022
5:38:34 PM



00115

8/21/2022
5:38:34 PM



00116

8/21/2022
5:38:34 PM



00117

6/21/2022
5:38:34 PM



00118

6/21/2022
5:38:34 PM



00119

8/21/2022
5:38:34 PM



00120

8/21/2022
5:38:34 PM



00121

8/21/2022
5:38:34 PM



00122

8/21/2022
5:38:34 PM



00123

8/21/2022
5:38:35 PM



00124

8/21/2022
5:38:35 PM



00125

8/21/2022
5:38:35 PM



00126

8/21/2022
5:38:35 PM



00127

6/21/2022
5:38:35 PM



00128

6/21/2022
5:38:35 PM



00129

6/21/2022
5:38:35 PM



00130

6/21/2022
5:38:35 PM



00131

6/21/2022
5:38:36 PM



00132

6/21/2022
5:38:36 PM



00133

6/21/2022
5:38:36 PM



00134

6/21/2022
5:38:36 PM



00135

6/21/2022
5:38:36 PM



00136

6/21/2022
5:38:36 PM



00137

6/21/2022
5:38:36 PM



00138

6/21/2022
5:38:36 PM



00139

6/21/2022
5:38:37 PM



00140

6/21/2022
5:38:37 PM



00141

6/21/2022
5:38:37 PM



00142

6/21/2022
5:38:37 PM



00143

8/21/2022
5:38:37 PM



00144

8/21/2022
5:38:37 PM



00145

6/21/2022
5:38:37 PM



00146

6/21/2022
5:38:37 PM



00147

8/21/2022
5:38:38 PM



00148

8/21/2022
5:38:38 PM



00149

6/21/2022
5:38:38 PM



00150

6/21/2022
5:38:38 PM



00151

6/21/2022
5:38:38 PM



00152

6/21/2022
5:38:38 PM



00153

8/21/2022
5:38:38 PM



00154

8/21/2022
5:38:38 PM



00155

6/21/2022
5:38:39 PM



00156

6/21/2022
5:38:39 PM



00157

8/21/2022
5:38:39 PM



00158

8/21/2022
5:38:39 PM



00159

8/21/2022
5:38:39 PM



00160

8/21/2022
5:38:39 PM



00161

8/21/2022
5:38:39 PM



00162

8/21/2022
5:38:39 PM



00163

8/21/2022
5:38:39 PM



00164

8/21/2022
5:38:40 PM



00165

8/21/2022
5:38:40 PM



00166

8/21/2022
5:38:40 PM



00167

6/21/2022
5:38:40 PM



00168

6/21/2022
5:38:40 PM



00169

6/21/2022
5:38:40 PM



00170

6/21/2022
5:38:40 PM



00171

6/21/2022
5:38:40 PM



00172

6/21/2022
5:38:41 PM



00173

6/21/2022
5:38:41 PM



00174

6/21/2022
5:38:41 PM



00175

6/21/2022
5:38:41 PM



00176

6/21/2022
5:38:41 PM



00177

6/21/2022
5:38:41 PM



00178

6/21/2022
5:38:41 PM



00179

6/21/2022
5:38:41 PM



00180

6/21/2022
5:38:41 PM



00181

8/21/2022
5:38:42 PM



00182

8/21/2022
5:38:42 PM



00183

6/21/2022
5:38:42 PM



00184

6/21/2022
5:38:42 PM



00185

8/21/2022
5:38:42 PM



00186

8/21/2022
5:38:42 PM



00187

8/21/2022
5:38:42 PM



00188

8/21/2022
5:38:42 PM



00189

8/21/2022
5:38:42 PM



00190

8/21/2022
5:38:43 PM



00191

6/21/2022
5:38:43 PM



00192

6/21/2022
5:38:43 PM



00193

8/21/2022
5:38:43 PM



00194

8/21/2022
5:38:43 PM



00195

8/21/2022
5:38:43 PM



00196

8/21/2022
5:38:43 PM



00197

6/21/2022
5:38:43 PM



00198

6/21/2022
5:38:44 PM



00199

6/21/2022
5:38:44 PM



00200

6/21/2022
5:38:44 PM



00201

8/21/2022
5:38:44 PM



00202

8/21/2022
5:38:44 PM



00203

6/21/2022
5:38:44 PM



00204

6/21/2022
5:38:44 PM



00205

8/21/2022
5:38:44 PM



00206

8/21/2022
5:38:45 PM



00207

8/21/2022
5:38:45 PM



00208

8/21/2022
5:38:45 PM



00209

8/21/2022
5:38:45 PM



00210

8/21/2022
5:38:45 PM



00211

8/21/2022
5:38:45 PM



00212

8/21/2022
5:38:45 PM



00213

8/21/2022
5:38:45 PM



00214

8/21/2022
5:38:45 PM



00215

8/21/2022
5:38:46 PM



00216

8/21/2022
5:38:46 PM



00217

8/21/2022
5:38:46 PM



00218

8/21/2022
5:38:46 PM



00219

6/21/2022
5:38:46 PM



00220

6/21/2022
5:38:46 PM



00221

8/21/2022
5:38:46 PM



00222

8/21/2022
5:38:46 PM



00223

8/21/2022
5:38:47 PM



00224

8/21/2022
5:38:47 PM



00225

8/21/2022
5:38:47 PM



00226

8/21/2022
5:38:47 PM



00227

6/21/2022
5:38:47 PM



00228

6/21/2022
5:38:47 PM



00229

8/21/2022
5:38:47 PM



00230

8/21/2022
5:38:47 PM



00231

ATTACHMENT 10: "SPOT 13" CAMERA IMAGE SEQUENCE

6/21/2022
5:37:18 PM

H-11 To SPOT 13- 14522



00152

6/21/2022
5:37:18 PM

H-11 To SPOT 13- 14522



00153

6/21/2022
5:37:18 PM

H-11 To SPOT 13- 14522



00154

6/21/2022
5:37:19 PM

H-11 To SPOT 13- 14522



00155

6/21/2022
5:37:19 PM

H-11 To SPOT 13- 14522



00156

6/21/2022
5:37:19 PM

H-11 To SPOT 13- 14522



00157

6/21/2022
5:37:19 PM

H-11 To SPOT 13- 14522



00158

6/21/2022
5:37:19 PM

H-11 To SPOT 13- 14522



00159

6/21/2022
5:37:19 PM

H-11 To SPOT 13- 14522



00160

6/21/2022
5:37:19 PM

H-11 To SPOT 13- 14522



00161

6/21/2022
5:37:20 PM

H-11 To SPOT 13- 14522



00162

6/21/2022
5:37:20 PM

H-11 To SPOT 13- 14522



00163

6/21/2022
5:37:20 PM

H-11 To SPOT 13- 14522



00164

6/21/2022
5:37:20 PM

H-11 To SPOT 13- 14522



00165

6/21/2022
5:37:20 PM

H-11 To SPOT 13- 14522



00166

6/21/2022
5:37:20 PM

H-11 To SPOT 13- 14522



00167

6/21/2022
5:37:20 PM

H-11 To SPOT 13- 14522



00168

6/21/2022
5:37:20 PM

H-11 To SPOT 13- 14522



00169

6/21/2022
5:37:21 PM

H-11 To SPOT 13- 14522



00170

6/21/2022
5:37:21 PM

H-11 To SPOT 13- 14522



00171

6/21/2022
5:37:21 PM

H-11 To SPOT 13- 14522



00172

6/21/2022
5:37:21 PM

H-11 To SPOT 13- 14522



00173

6/21/2022
5:37:21 PM

H-11 To SPOT 13- 14522



00174

6/21/2022
5:37:21 PM

H-11 To SPOT 13- 14522



00175

6/21/2022
5:37:21 PM

H-11 To SPOT 13- 14522



00176

6/21/2022
5:37:22 PM

H-11 To SPOT 13- 14522



00177

6/21/2022
5:37:22 PM

H-11 To SPOT 13- 14522



00178

6/21/2022
5:37:22 PM

H-11 To SPOT 13- 14522



00179

6/21/2022
5:37:22 PM

H-11 To SPOT 13- 14522



00180

6/21/2022
5:37:22 PM

H-11 To SPOT 13- 14522



00181

6/21/2022
5:37:22 PM

H-11 To SPOT 13- 14522



00182

6/21/2022
5:37:22 PM

H-11 To SPOT 13- 14522



00183

6/21/2022
5:37:22 PM

H-11 To SPOT 13- 14522



00184

6/21/2022
5:37:23 PM

H-11 To SPOT 13- 14522



00185

6/21/2022
5:37:23 PM

H-11 To SPOT 13- 14522



00186

6/21/2022
5:37:23 PM

H-11 To SPOT 13- 14522



00187

6/21/2022
5:37:23 PM

H-11 To SPOT 13- 14522



00188

6/21/2022
5:37:23 PM

H-11 To SPOT 13- 14522



00189

6/21/2022
5:37:23 PM

H-11 To SPOT 13- 14522



00190

6/21/2022
5:37:23 PM

H-11 To SPOT 13- 14522



00191

6/21/2022
5:37:24 PM

H-11 To SPOT 13- 14522



00192

6/21/2022
5:37:24 PM

H-11 To SPOT 13- 14522



00193

6/21/2022
5:37:24 PM

H-11 To SPOT 13- 14522



00194

6/21/2022
5:37:24 PM

H-11 To SPOT 13- 14522



00195

6/21/2022
5:37:24 PM

H-11 To SPOT 13- 14522



00196

6/21/2022
5:37:24 PM

H-11 To SPOT 13- 14522



00197

6/21/2022
5:37:24 PM

H-11 To SPOT 13- 14522



00198

6/21/2022
5:37:24 PM

H-11 To SPOT 13- 14522



00199

6/21/2022
5:37:25 PM

H-11 To SPOT 13- 14522



00200

6/21/2022
5:37:25 PM

H-11 To SPOT 13- 14522



00201

6/21/2022
5:37:25 PM

H-11 To SPOT 13- 14522



00202

6/21/2022
5:37:25 PM

H-11 To SPOT 13- 14522



00203

6/21/2022
5:37:25 PM

H-11 To SPOT 13- 14522



00204

6/21/2022
5:37:25 PM

H-11 To SPOT 13- 14522



00205

6/21/2022
5:37:25 PM

H-11 To SPOT 13- 14522



00206

6/21/2022
5:37:26 PM

H-11 To SPOT 13- 14522



00207

6/21/2022
5:37:26 PM

H-11 To SPOT 13- 14522



00208

6/21/2022
5:37:26 PM

H-11 To SPOT 13- 14522



00209

6/21/2022
5:37:26 PM

H-11 To SPOT 13- 14522



00210

6/21/2022
5:37:26 PM

H-11 To SPOT 13- 14522



00211

6/21/2022
5:37:26 PM

H-11 To SPOT 13- 14522



00212

6/21/2022
5:37:26 PM

H-11 To SPOT 13- 14522



00213

6/21/2022
5:37:26 PM

H-11 To SPOT 13- 14522



00214

6/21/2022
5:37:27 PM

H-11 To SPOT 13- 14522



00215

6/21/2022
5:37:27 PM

H-11 To SPOT 13- 14522



00216

6/21/2022
5:37:27 PM

H-11 To SPOT 13- 14522



00217

6/21/2022
5:37:27 PM

H-11 To SPOT 13- 14522



00218

6/21/2022
5:37:27 PM

H-11 To SPOT 13- 14522



00219

6/21/2022
5:37:27 PM

H-11 To SPOT 13- 14522



00220

6/21/2022
5:37:27 PM

H-11 To SPOT 13- 14522



00221

6/21/2022
5:37:28 PM

H-11 To SPOT 13- 14522



00222

6/21/2022
5:37:28 PM

H-11 To SPOT 13- 14522



00223

6/21/2022
5:37:28 PM

H-11 To SPOT 13- 14522



00224

6/21/2022
5:37:28 PM

H-11 To SPOT 13- 14522



00225

6/21/2022
5:37:28 PM

H-11 To SPOT 13- 14522



00226

6/21/2022
5:37:28 PM

H-11 To SPOT 13- 14522



00227

6/21/2022
5:37:28 PM

H-11 To SPOT 13- 14522



00228

6/21/2022
5:37:28 PM

H-11 To SPOT 13- 14522



00229

6/21/2022
5:37:29 PM

H-11 To SPOT 13- 14522



00230

6/21/2022
5:37:29 PM

H-11 To SPOT 13- 14522



00231

6/21/2022
5:37:29 PM

H-11 To SPOT 13- 14522



00232

6/21/2022
5:37:29 PM

H-11 To SPOT 13- 14522



00233

6/21/2022
5:37:29 PM

H-11 To SPOT 13- 14522



00234

6/21/2022
5:37:29 PM

H-11 To SPOT 13- 14522



00235

6/21/2022
5:37:29 PM

H-11 To SPOT 13- 14522



00236

6/21/2022
5:37:30 PM

H-11 To SPOT 13- 14522



00237

6/21/2022
5:37:30 PM

H-11 To SPOT 13- 14522



00238

6/21/2022
5:37:30 PM

H-11 To SPOT 13- 14522



00239

6/21/2022
5:37:30 PM

H-11 To SPOT 13- 14522



00240

6/21/2022
5:37:30 PM

H-11 To SPOT 13- 14522



00241

6/21/2022
5:37:30 PM

H-11 To SPOT 13- 14522



00242

6/21/2022
5:37:30 PM

H-11 To SPOT 13- 14522



00243

6/21/2022
5:37:30 PM

H-11 To SPOT 13- 14522



00244

6/21/2022
5:37:31 PM

H-11 To SPOT 13- 14522



00245

6/21/2022
5:37:31 PM

H-11 To SPOT 13- 14522



00246

6/21/2022
5:37:31 PM

H-11 To SPOT 13- 14522



00247

6/21/2022
5:37:31 PM

H-11 To SPOT 13- 14522



00248

6/21/2022
5:37:31 PM

H-11 To SPOT 13- 14522



00249

6/21/2022
5:37:31 PM

H-11 To SPOT 13- 14522



00250

6/21/2022
5:37:31 PM

H-11 To SPOT 13- 14522



00251

6/21/2022
5:37:32 PM

H-11 To SPOT 13- 14522



00252

6/21/2022
5:37:32 PM

H-11 To SPOT 13- 14522



00253

6/21/2022
5:37:32 PM

H-11 To SPOT 13- 14522



00254

6/21/2022
5:37:32 PM

H-11 To SPOT 13- 14522



00255

6/21/2022
5:37:32 PM

H-11 To SPOT 13- 14522



00256

6/21/2022
5:37:32 PM

H-11 To SPOT 13- 14522



00257

6/21/2022
5:37:32 PM

H-11 To SPOT 13- 14522



00258

6/21/2022
5:37:33 PM

H-11 To SPOT 13- 14522



00259

6/21/2022
5:37:33 PM

H-11 To SPOT 13- 14522



00260

6/21/2022
5:37:33 PM

H-11 To SPOT 13- 14522



00261

6/21/2022
5:37:33 PM

H-11 To SPOT 13- 14522



00262

6/21/2022
5:37:33 PM

H-11 To SPOT 13- 14522



00263

6/21/2022
5:37:33 PM

H-11 To SPOT 13- 14522



00264

6/21/2022
5:37:33 PM

H-11 To SPOT 13- 14522



00265

6/21/2022
5:37:34 PM

H-11 To SPOT 13- 14522



00266

6/21/2022
5:37:34 PM

H-11 To SPOT 13- 14522



00267

6/21/2022
5:37:34 PM

H-11 To SPOT 13- 14522



00268

6/21/2022
5:37:34 PM

H-11 To SPOT 13- 14522



00269

6/21/2022
5:37:34 PM

H-11 To SPOT 13- 14522



00270

6/21/2022
5:37:34 PM

H-11 To SPOT 13- 14522



00271

6/21/2022
5:37:34 PM

H-11 To SPOT 13- 14522



00272

6/21/2022
5:37:34 PM

H-11 To SPOT 13- 14522



00273

6/21/2022
5:37:35 PM

H-11 To SPOT 13- 14522



00274

6/21/2022
5:37:35 PM

H-11 To SPOT 13- 14522



00275

6/21/2022
5:37:35 PM

H-11 To SPOT 13- 14522



00276

6/21/2022
5:37:35 PM

H-11 To SPOT 13- 14522



00277

6/21/2022
5:37:35 PM

H-11 To SPOT 13- 14522



00278

6/21/2022
5:37:35 PM

H-11 To SPOT 13- 14522



00279

6/21/2022
5:37:35 PM

H-11 To SPOT 13- 14522



00280

6/21/2022
5:37:36 PM

H-11 To SPOT 13- 14522



00281

6/21/2022
5:37:36 PM

H-11 To SPOT 13- 14522



00282

6/21/2022
5:37:36 PM

H-11 To SPOT 13- 14522



00283

6/21/2022
5:37:36 PM

H-11 To SPOT 13- 14522



00284

6/21/2022
5:37:36 PM

H-11 To SPOT 13- 14522



00285

6/21/2022
5:37:36 PM

H-11 To SPOT 13- 14522



00286

6/21/2022
5:37:36 PM

H-11 To SPOT 13- 14522



00287

6/21/2022
5:37:36 PM

H-11 To SPOT 13- 14522



00288

6/21/2022
5:37:37 PM

H-11 To SPOT 13- 14522



00289

6/21/2022
5:37:37 PM

H-11 To SPOT 13- 14522



00290

6/21/2022
5:37:37 PM

H-11 To SPOT 13- 14522



00291

6/21/2022
5:37:37 PM

H-11 To SPOT 13- 14522



00292

6/21/2022
5:37:37 PM

H-11 To SPOT 13- 14522



00293

6/21/2022
5:37:37 PM

H-11 To SPOT 13- 14522



00294

6/21/2022
5:37:37 PM

H-11 To SPOT 13- 14522



00295

6/21/2022
5:37:38 PM

H-11 To SPOT 13- 14522



00296

6/21/2022
5:37:38 PM

H-11 To SPOT 13- 14522



00297

6/21/2022
5:37:38 PM

H-11 To SPOT 13- 14522



00298

6/21/2022
5:37:38 PM

H-11 To SPOT 13- 14522



00299

6/21/2022
5:37:38 PM

H-11 To SPOT 13- 14522



00300

6/21/2022
5:37:38 PM

H-11 To SPOT 13- 14522



00301

6/21/2022
5:37:38 PM

H-11 To SPOT 13- 14522



00302

6/21/2022
5:37:38 PM

H-11 To SPOT 13- 14522



00303

6/21/2022
5:37:39 PM

H-11 To SPOT 13- 14522



00304

6/21/2022
5:37:39 PM

H-11 To SPOT 13- 14522



00305

6/21/2022
5:37:39 PM

H-11 To SPOT 13- 14522



00306

6/21/2022
5:37:39 PM

H-11 To SPOT 13- 14522



00307

6/21/2022
5:37:39 PM

H-11 To SPOT 13- 14522



00308

6/21/2022
5:37:39 PM

H-11 To SPOT 13- 14522



00309

6/21/2022
5:37:39 PM

H-11 To SPOT 13- 14522



00310

6/21/2022
5:37:40 PM

H-11 To SPOT 13- 14522



00311

6/21/2022
5:37:40 PM

H-11 To SPOT 13- 14522



00312

6/21/2022
5:37:40 PM

H-11 To SPOT 13- 14522



00313

6/21/2022
5:37:40 PM

H-11 To SPOT 13- 14522



00314

6/21/2022
5:37:40 PM

H-11 To SPOT 13- 14522



00315

6/21/2022
5:37:40 PM

H-11 To SPOT 13- 14522



00316

6/21/2022
5:37:40 PM

H-11 To SPOT 13- 14522



00317

6/21/2022
5:37:40 PM

H-11 To SPOT 13- 14522



00318

6/21/2022
5:37:41 PM

H-11 To SPOT 13- 14522



00319

6/21/2022
5:37:41 PM

H-11 To SPOT 13- 14522



00320

6/21/2022
5:37:41 PM

H-11 To SPOT 13- 14522



00321

6/21/2022
5:37:41 PM

H-11 To SPOT 13- 14522



00322

6/21/2022
5:37:41 PM

H-11 To SPOT 13- 14522



00323

6/21/2022
5:37:41 PM

H-11 To SPOT 13- 14522



00324

6/21/2022
5:37:41 PM

H-11 To SPOT 13- 14522



00325

6/21/2022
5:37:42 PM

H-11 To SPOT 13- 14522



00326

6/21/2022
5:37:42 PM

H-11 To SPOT 13- 14522



00327

6/21/2022
5:37:42 PM

H-11 To SPOT 13- 14522



6/21/2022
5:37:42 PM

H-11 To SPOT 13- 14522



6/21/2022
5:37:42 PM

H-11 To SPOT 13- 14522



00330

6/21/2022
5:37:42 PM

H-11 To SPOT 13- 14522



00331

6/21/2022
5:37:42 PM

H-11 To SPOT 13- 14522



00332

6/21/2022
5:37:42 PM

H-11 To SPOT 13- 14522



00333

6/21/2022
5:37:43 PM

H-11 To SPOT 13- 14522



00334

6/21/2022
5:37:43 PM

H-11 To SPOT 13- 14522



00335

6/21/2022
5:37:43 PM

H-11 To SPOT 13- 14522



00336

6/21/2022
5:37:43 PM

H-11 To SPOT 13- 14522



00337

6/21/2022
5:37:43 PM

H-11 To SPOT 13- 14522



00338

6/21/2022
5:37:43 PM

H-11 To SPOT 13- 14522



00339

6/21/2022
5:37:43 PM

H-11 To SPOT 13- 14522



00340

6/21/2022
5:37:44 PM

H-11 To SPOT 13- 14522



00341

6/21/2022
5:37:44 PM

H-11 To SPOT 13- 14522



00342

6/21/2022
5:37:44 PM

H-11 To SPOT 13- 14522



00343

6/21/2022
5:37:44 PM

H-11 To SPOT 13- 14522



00344

6/21/2022
5:37:44 PM

H-11 To SPOT 13- 14522



00345

6/21/2022
5:37:44 PM

H-11 To SPOT 13- 14522



00346

6/21/2022
5:37:44 PM

H-11 To SPOT 13- 14522



00347

6/21/2022
5:37:44 PM

H-11 To SPOT 13- 14522



00348

6/21/2022
5:37:45 PM

H-11 To SPOT 13- 14522



00349

6/21/2022
5:37:45 PM

H-11 To SPOT 13- 14522



00350

6/21/2022
5:37:45 PM

H-11 To SPOT 13- 14522



00351

6/21/2022
5:37:45 PM

H-11 To SPOT 13- 14522



00352

6/21/2022
5:37:45 PM

H-11 To SPOT 13- 14522



00353

6/21/2022
5:37:45 PM

H-11 To SPOT 13- 14522



00354

6/21/2022
5:37:45 PM

H-11 To SPOT 13- 14522



00355

6/21/2022
5:37:46 PM

H-11 To SPOT 13- 14522



00356

6/21/2022
5:37:46 PM

H-11 To SPOT 13- 14522



00357

6/21/2022
5:37:46 PM

H-11 To SPOT 13- 14522



00358

6/21/2022
5:37:46 PM

H-11 To SPOT 13- 14522



00359

6/21/2022
5:37:46 PM

H-11 To SPOT 13- 14522



00360

6/21/2022
5:37:46 PM

H-11 To SPOT 13- 14522



00361

6/21/2022
5:37:46 PM

H-11 To SPOT 13- 14522



00362

6/21/2022
5:37:46 PM

H-11 To SPOT 13- 14522



00363

6/21/2022
5:37:47 PM

H-11 To SPOT 13- 14522



00364

6/21/2022
5:37:47 PM

H-11 To SPOT 13- 14522



00365

6/21/2022
5:37:47 PM

H-11 To SPOT 13- 14522



00366

6/21/2022
5:37:47 PM

H-11 To SPOT 13- 14522



00367

6/21/2022
5:37:47 PM

H-11 To SPOT 13- 14522



00368

6/21/2022
5:37:47 PM

H-11 To SPOT 13- 14522



00369

6/21/2022
5:37:47 PM

H-11 To SPOT 13- 14522



00370

6/21/2022
5:37:48 PM

H-11 To SPOT 13- 14522



00371

6/21/2022
5:37:48 PM

H-11 To SPOT 13- 14522



00372

6/21/2022
5:37:48 PM

H-11 To SPOT 13- 14522



00373

6/21/2022
5:37:48 PM

H-11 To SPOT 13- 14522



00374

6/21/2022
5:37:48 PM

H-11 To SPOT 13- 14522



00375

6/21/2022
5:37:48 PM

H-11 To SPOT 13- 14522



00376

6/21/2022
5:37:48 PM

H-11 To SPOT 13- 14522



00377

6/21/2022
5:37:48 PM

H-11 To SPOT 13- 14522



00378

6/21/2022
5:37:49 PM

H-11 To SPOT 13- 14522



00379

6/21/2022
5:37:49 PM

H-11 To SPOT 13- 14522



00380

6/21/2022
5:37:49 PM

H-11 To SPOT 13- 14522



00381

6/21/2022
5:37:49 PM

H-11 To SPOT 13- 14522



00382

6/21/2022
5:37:49 PM

H-11 To SPOT 13- 14522



00383

6/21/2022
5:37:49 PM

H-11 To SPOT 13- 14522



00384

6/21/2022
5:37:49 PM

H-11 To SPOT 13- 14522



00385

6/21/2022
5:37:50 PM

H-11 To SPOT 13- 14522



00386

6/21/2022
5:37:50 PM

H-11 To SPOT 13- 14522



00387

6/21/2022
5:37:50 PM

H-11 To SPOT 13- 14522



00388

6/21/2022
5:37:50 PM

H-11 To SPOT 13- 14522



00389

6/21/2022
5:37:50 PM

H-11 To SPOT 13- 14522



00390

6/21/2022
5:37:50 PM

H-11 To SPOT 13- 14522



00391

6/21/2022
5:37:50 PM

H-11 To SPOT 13- 14522



00392

6/21/2022
5:37:51 PM

H-11 To SPOT 13- 14522



00393

6/21/2022
5:37:51 PM

H-11 To SPOT 13- 14522



00394

6/21/2022
5:37:51 PM

H-11 To SPOT 13- 14522



00395

6/21/2022
5:37:51 PM

H-11 To SPOT 13- 14522



00396

6/21/2022
5:37:51 PM

H-11 To SPOT 13- 14522



00397

6/21/2022
5:37:51 PM

H-11 To SPOT 13- 14522



00398

6/21/2022
5:37:51 PM

H-11 To SPOT 13- 14522



00399

6/21/2022
5:37:52 PM

H-11 To SPOT 13- 14522



00400

6/21/2022
5:37:52 PM

H-11 To SPOT 13- 14522



00401

6/21/2022
5:37:52 PM

H-11 To SPOT 13- 14522



00402

6/21/2022
5:37:52 PM

H-11 To SPOT 13- 14522



00403

6/21/2022
5:37:52 PM

H-11 To SPOT 13- 14522



00404

6/21/2022
5:37:52 PM

H-11 To SPOT 13- 14522



00405

6/21/2022
5:37:53 PM

H-11 To SPOT 13- 14522



00406

6/21/2022
5:37:53 PM

H-11 To SPOT 13- 14522



00407

6/21/2022
5:37:53 PM

H-11 To SPOT 13- 14522



00408

6/21/2022
5:37:53 PM

H-11 To SPOT 13- 14522



00409

6/21/2022
5:37:53 PM

H-11 To SPOT 13- 14522



00410

6/21/2022
5:37:53 PM

H-11 To SPOT 13- 14522



00411

6/21/2022
5:37:53 PM

H-11 To SPOT 13- 14522



00412

6/21/2022
5:37:54 PM

H-11 To SPOT 13- 14522



00413

6/21/2022
5:37:54 PM

H-11 To SPOT 13- 14522



00414

6/21/2022
5:37:54 PM

H-11 To SPOT 13- 14522



00415

6/21/2022
5:37:54 PM

H-11 To SPOT 13- 14522



00416

6/21/2022
5:37:54 PM

H-11 To SPOT 13- 14522



00417

6/21/2022
5:37:54 PM

H-11 To SPOT 13- 14522



00418

6/21/2022
5:37:54 PM

H-11 To SPOT 13- 14522



00419

6/21/2022
5:37:54 PM

H-11 To SPOT 13- 14522



00420

6/21/2022
5:37:55 PM

H-11 To SPOT 13- 14522



00421

6/21/2022
5:37:55 PM

H-11 To SPOT 13- 14522



00422

6/21/2022
5:37:55 PM

H-11 To SPOT 13- 14522



00423

6/21/2022
5:37:55 PM

H-11 To SPOT 13- 14522



00424

6/21/2022
5:37:55 PM

H-11 To SPOT 13- 14522



00425

6/21/2022
5:37:55 PM

H-11 To SPOT 13- 14522



00426

6/21/2022
5:37:55 PM

H-11 To SPOT 13- 14522



00427

6/21/2022
5:37:56 PM

H-11 To SPOT 13- 14522



00428

6/21/2022
5:37:56 PM

H-11 To SPOT 13- 14522



00429

6/21/2022
5:37:56 PM

H-11 To SPOT 13- 14522



00430

6/21/2022
5:37:56 PM

H-11 To SPOT 13- 14522



00431

6/21/2022
5:37:56 PM

H-11 To SPOT 13- 14522



00432

6/21/2022
5:37:56 PM

H-11 To SPOT 13- 14522



00433

6/21/2022
5:37:56 PM

H-11 To SPOT 13- 14522



00434

6/21/2022
5:37:56 PM

H-11 To SPOT 13- 14522



00435

6/21/2022
5:37:57 PM

H-11 To SPOT 13- 14522



00436

6/21/2022
5:37:57 PM

H-11 To SPOT 13- 14522



00437

6/21/2022
5:37:57 PM

H-11 To SPOT 13- 14522



00438

6/21/2022
5:37:57 PM

H-11 To SPOT 13- 14522



00439

6/21/2022
5:37:57 PM

H-11 To SPOT 13- 14522



00440

6/21/2022
5:37:57 PM

H-11 To SPOT 13- 14522



00441

6/21/2022
5:37:57 PM

H-11 To SPOT 13- 14522



00442

6/21/2022
5:37:58 PM

H-11 To SPOT 13- 14522



00443

6/21/2022
5:37:58 PM

H-11 To SPOT 13- 14522



00444

6/21/2022
5:37:58 PM

H-11 To SPOT 13- 14522



00445

6/21/2022
5:37:58 PM

H-11 To SPOT 13- 14522



00446

6/21/2022
5:37:58 PM

H-11 To SPOT 13- 14522



00447

6/21/2022
5:37:58 PM

H-11 To SPOT 13- 14522



00448

6/21/2022
5:37:58 PM

H-11 To SPOT 13- 14522



00449

6/21/2022
5:37:59 PM

H-11 To SPOT 13- 14522



00450

6/21/2022
5:37:59 PM

H-11 To SPOT 13- 14522



00451

6/21/2022
5:37:59 PM

H-11 To SPOT 13- 14522



00452

6/21/2022
5:37:59 PM

H-11 To SPOT 13- 14522



00453

6/21/2022
5:37:59 PM

H-11 To SPOT 13- 14522



00454

6/21/2022
5:37:59 PM

H-11 To SPOT 13- 14522



00455

6/21/2022
5:37:59 PM

H-11 To SPOT 13- 14522



00456

6/21/2022
5:38:00 PM

H-11 To SPOT 13- 14522



00457

6/21/2022
5:38:00 PM

H-11 To SPOT 13- 14522



00458

6/21/2022
5:38:00 PM

H-11 To SPOT 13- 14522



00459

6/21/2022
5:38:00 PM

H-11 To SPOT 13- 14522



00460

6/21/2022
5:38:00 PM

H-11 To SPOT 13- 14522



00461

6/21/2022
5:38:00 PM

H-11 To SPOT 13- 14522



00462

6/21/2022
5:38:00 PM

H-11 To SPOT 13- 14522



00463

6/21/2022
5:38:00 PM

H-11 To SPOT 13- 14522



00464

6/21/2022
5:38:01 PM

H-11 To SPOT 13- 14522



00465

6/21/2022
5:38:01 PM

H-11 To SPOT 13- 14522



00466

6/21/2022
5:38:01 PM

H-11 To SPOT 13- 14522



00467

6/21/2022
5:38:01 PM

H-11 To SPOT 13- 14522



00468

6/21/2022
5:38:01 PM

H-11 To SPOT 13- 14522



00469

6/21/2022
5:38:01 PM

H-11 To SPOT 13- 14522



00470

6/21/2022
5:38:01 PM

H-11 To SPOT 13- 14522



00471

6/21/2022
5:38:02 PM

H-11 To SPOT 13- 14522



6/21/2022
5:38:02 PM

H-11 To SPOT 13- 14522



6/21/2022
5:38:02 PM

H-11 To SPOT 13- 14522



00474

6/21/2022
5:38:02 PM

H-11 To SPOT 13- 14522



00475

6/21/2022
5:38:02 PM

H-11 To SPOT 13- 14522



00476

6/21/2022
5:38:02 PM

H-11 To SPOT 13- 14522



00477

6/21/2022
5:38:02 PM

H-11 To SPOT 13- 14522



00478

6/21/2022
5:38:02 PM

H-11 To SPOT 13- 14522



00479

6/21/2022
5:38:03 PM

H-11 To SPOT 13- 14522



00480

6/21/2022
5:38:03 PM

H-11 To SPOT 13- 14522



00481

6/21/2022
5:38:03 PM

H-11 To SPOT 13- 14522



00482

6/21/2022
5:38:03 PM

H-11 To SPOT 13- 14522



00483

6/21/2022
5:38:03 PM

H-11 To SPOT 13- 14522



00484

6/21/2022
5:38:03 PM

H-11 To SPOT 13- 14522



00485

6/21/2022
5:38:03 PM

H-11 To SPOT 13- 14522



00486

6/21/2022
5:38:04 PM

H-11 To SPOT 13- 14522



00487

6/21/2022
5:38:04 PM

H-11 To SPOT 13- 14522



00488

6/21/2022
5:38:04 PM

H-11 To SPOT 13- 14522



00489

6/21/2022
5:38:04 PM

H-11 To SPOT 13- 14522



00490

6/21/2022
5:38:04 PM

H-11 To SPOT 13- 14522



00491

6/21/2022
5:38:04 PM

H-11 To SPOT 13- 14522



00492

6/21/2022
5:38:04 PM

H-11 To SPOT 13- 14522



00493

6/21/2022
5:38:04 PM

H-11 To SPOT 13- 14522



00494

6/21/2022
5:38:05 PM

H-11 To SPOT 13- 14522



00495

6/21/2022
5:38:05 PM

H-11 To SPOT 13- 14522



00496

6/21/2022
5:38:05 PM

H-11 To SPOT 13- 14522



00497

6/21/2022
5:38:05 PM

H-11 To SPOT 13- 14522



00498

6/21/2022
5:38:05 PM

H-11 To SPOT 13- 14522



00499

6/21/2022
5:38:05 PM

H-11 To SPOT 13- 14522



00500

6/21/2022
5:38:05 PM

H-11 To SPOT 13- 14522



00501

6/21/2022
5:38:06 PM

H-11 To SPOT 13- 14522



00502

6/21/2022
5:38:06 PM

H-11 To SPOT 13- 14522



00503

6/21/2022
5:38:06 PM

H-11 To SPOT 13- 14522



00504

6/21/2022
5:38:06 PM

H-11 To SPOT 13- 14522



00505

6/21/2022
5:38:06 PM

H-11 To SPOT 13- 14522



00506

6/21/2022
5:38:06 PM

H-11 To SPOT 13- 14522



00507

6/21/2022
5:38:06 PM

H-11 To SPOT 13- 14522



00508

6/21/2022
5:38:07 PM

H-11 To SPOT 13- 14522



00509

6/21/2022
5:38:07 PM

H-11 To SPOT 13- 14522



00510

6/21/2022
5:38:07 PM

H-11 To SPOT 13- 14522



00511

6/21/2022
5:38:07 PM

H-11 To SPOT 13- 14522



00512

6/21/2022
5:38:07 PM

H-11 To SPOT 13- 14522



00513

6/21/2022
5:38:07 PM

H-11 To SPOT 13- 14522



00514

6/21/2022
5:38:07 PM

H-11 To SPOT 13- 14522



00515

6/21/2022
5:38:08 PM

H-11 To SPOT 13- 14522



00516

6/21/2022
5:38:08 PM

H-11 To SPOT 13- 14522



00517

6/21/2022
5:38:08 PM

H-11 To SPOT 13- 14522



00518

6/21/2022
5:38:08 PM

H-11 To SPOT 13- 14522



00519

6/21/2022
5:38:08 PM

H-11 To SPOT 13- 14522



00520

6/21/2022
5:38:08 PM

H-11 To SPOT 13- 14522



00521

6/21/2022
5:38:08 PM

H-11 To SPOT 13- 14522



00522

6/21/2022
5:38:08 PM

H-11 To SPOT 13- 14522



00523

6/21/2022
5:38:09 PM

H-11 To SPOT 13- 14522



00524

6/21/2022
5:38:09 PM

H-11 To SPOT 13- 14522



00525

6/21/2022
5:38:09 PM

H-11 To SPOT 13- 14522



00526

6/21/2022
5:38:09 PM

H-11 To SPOT 13- 14522



00527

6/21/2022
5:38:09 PM

H-11 To SPOT 13- 14522



00528

6/21/2022
5:38:09 PM

H-11 To SPOT 13- 14522



00529

6/21/2022
5:38:09 PM

H-11 To SPOT 13- 14522



00530

6/21/2022
5:38:10 PM

H-11 To SPOT 13- 14522



00531

6/21/2022
5:38:10 PM

H-11 To SPOT 13- 14522



00532

6/21/2022
5:38:10 PM

H-11 To SPOT 13- 14522



00533

6/21/2022
5:38:10 PM

H-11 To SPOT 13- 14522



00534

6/21/2022
5:38:10 PM

H-11 To SPOT 13- 14522



00535

6/21/2022
5:38:10 PM

H-11 To SPOT 13- 14522



00536

6/21/2022
5:38:10 PM

H-11 To SPOT 13- 14522



00537

6/21/2022
5:38:10 PM

H-11 To SPOT 13- 14522



00538

6/21/2022
5:38:11 PM

H-11 To SPOT 13- 14522



00539

6/21/2022
5:38:11 PM

H-11 To SPOT 13- 14522



00540

6/21/2022
5:38:11 PM

H-11 To SPOT 13- 14522



00541

6/21/2022
5:38:11 PM

H-11 To SPOT 13- 14522



00542

6/21/2022
5:38:11 PM

H-11 To SPOT 13- 14522



00543

6/21/2022
5:38:11 PM

H-11 To SPOT 13- 14522



00544

6/21/2022
5:38:11 PM

H-11 To SPOT 13- 14522



00545

6/21/2022
5:38:12 PM

H-11 To SPOT 13- 14522



00546

6/21/2022
5:38:12 PM

H-11 To SPOT 13- 14522



00547

6/21/2022
5:38:12 PM

H-11 To SPOT 13- 14522



00548

6/21/2022
5:38:12 PM

H-11 To SPOT 13- 14522



00549

6/21/2022
5:38:12 PM

H-11 To SPOT 13- 14522



00550

6/21/2022
5:38:12 PM

H-11 To SPOT 13- 14522



00551

6/21/2022
5:38:12 PM

H-11 To SPOT 13- 14522



00552

6/21/2022
5:38:13 PM

H-11 To SPOT 13- 14522



00553

6/21/2022
5:38:13 PM

H-11 To SPOT 13- 14522



00554

6/21/2022
5:38:13 PM

H-11 To SPOT 13- 14522



00555

6/21/2022
5:38:13 PM

H-11 To SPOT 13- 14522



00556

6/21/2022
5:38:13 PM

H-11 To SPOT 13- 14522



00557

6/21/2022
5:38:13 PM

H-11 To SPOT 13- 14522



00558

6/21/2022
5:38:13 PM

H-11 To SPOT 13- 14522



00559

6/21/2022
5:38:14 PM

H-11 To SPOT 13- 14522



00560

6/21/2022
5:38:14 PM

H-11 To SPOT 13- 14522



00561

6/21/2022
5:38:14 PM

H-11 To SPOT 13- 14522



00562

6/21/2022
5:38:14 PM

H-11 To SPOT 13- 14522



00563

6/21/2022
5:38:14 PM

H-11 To SPOT 13- 14522



00564

6/21/2022
5:38:14 PM

H-11 To SPOT 13- 14522



00565

6/21/2022
5:38:14 PM

H-11 To SPOT 13- 14522



00566

6/21/2022
5:38:14 PM

H-11 To SPOT 13- 14522



00567

6/21/2022
5:38:15 PM

H-11 To SPOT 13- 14522



00568

6/21/2022
5:38:15 PM

H-11 To SPOT 13- 14522



00569

6/21/2022
5:38:15 PM

H-11 To SPOT 13- 14522



00570

6/21/2022
5:38:15 PM

H-11 To SPOT 13- 14522



00571

6/21/2022
5:38:15 PM

H-11 To SPOT 13- 14522



00572

6/21/2022
5:38:15 PM

H-11 To SPOT 13- 14522



00573

6/21/2022
5:38:15 PM

H-11 To SPOT 13- 14522



00574

6/21/2022
5:38:16 PM

H-11 To SPOT 13- 14522



00575

6/21/2022
5:38:16 PM

H-11 To SPOT 13- 14522



00576

6/21/2022
5:38:16 PM

H-11 To SPOT 13- 14522



00577

6/21/2022
5:38:16 PM

H-11 To SPOT 13- 14522



00578

6/21/2022
5:38:16 PM

H-11 To SPOT 13- 14522



00579

6/21/2022
5:38:16 PM

H-11 To SPOT 13- 14522



00580

6/21/2022
5:38:16 PM

H-11 To SPOT 13- 14522



00581

6/21/2022
5:38:16 PM

H-11 To SPOT 13- 14522



00582

6/21/2022
5:38:17 PM

H-11 To SPOT 13- 14522



00583

6/21/2022
5:38:17 PM

H-11 To SPOT 13- 14522



00584

6/21/2022
5:38:17 PM

H-11 To SPOT 13- 14522



00585

6/21/2022
5:38:17 PM

H-11 To SPOT 13- 14522



00586

6/21/2022
5:38:17 PM

H-11 To SPOT 13- 14522



00587

6/21/2022
5:38:17 PM

H-11 To SPOT 13- 14522



00588

6/21/2022
5:38:17 PM

H-11 To SPOT 13- 14522



00589

6/21/2022
5:38:18 PM

H-11 To SPOT 13- 14522



00590

6/21/2022
5:38:18 PM

H-11 To SPOT 13- 14522



00591

6/21/2022
5:38:18 PM

H-11 To SPOT 13- 14522



00592

6/21/2022
5:38:18 PM

H-11 To SPOT 13- 14522



00593

6/21/2022
5:38:18 PM

H-11 To SPOT 13- 14522



00594

6/21/2022
5:38:18 PM

H-11 To SPOT 13- 14522



00595

6/21/2022
5:38:18 PM

H-11 To SPOT 13- 14522



00596

6/21/2022
5:38:18 PM

H-11 To SPOT 13- 14522



00597

6/21/2022
5:38:19 PM

H-11 To SPOT 13- 14522



00598

6/21/2022
5:38:19 PM

H-11 To SPOT 13- 14522



00599

6/21/2022
5:38:19 PM

H-11 To SPOT 13- 14522



00600

6/21/2022
5:38:19 PM

H-11 To SPOT 13- 14522



00601

6/21/2022
5:38:19 PM

H-11 To SPOT 13- 14522



00602

6/21/2022
5:38:19 PM

H-11 To SPOT 13- 14522



00603

6/21/2022
5:38:19 PM

H-11 To SPOT 13- 14522



00604

6/21/2022
5:38:20 PM

H-11 To SPOT 13- 14522



00605

6/21/2022
5:38:20 PM

H-11 To SPOT 13- 14522



00606

6/21/2022
5:38:20 PM

H-11 To SPOT 13- 14522



00607

6/21/2022
5:38:20 PM

H-11 To SPOT 13- 14522



00608

6/21/2022
5:38:20 PM

H-11 To SPOT 13- 14522



00609

6/21/2022
5:38:20 PM

H-11 To SPOT 13- 14522



00610

6/21/2022
5:38:20 PM

H-11 To SPOT 13- 14522



00611

6/21/2022
5:38:20 PM

H-11 To SPOT 13- 14522



00612

6/21/2022
5:38:21 PM

H-11 To SPOT 13- 14522



00613

6/21/2022
5:38:21 PM

H-11 To SPOT 13- 14522



00614

6/21/2022
5:38:21 PM

H-11 To SPOT 13- 14522



00615

6/21/2022
5:38:21 PM

H-11 To SPOT 13- 14522



00616

6/21/2022
5:38:21 PM

H-11 To SPOT 13- 14522



00617

6/21/2022
5:38:21 PM

H-11 To SPOT 13- 14522



00618

6/21/2022
5:38:21 PM

H-11 To SPOT 13- 14522



00619

6/21/2022
5:38:22 PM

H-11 To SPOT 13- 14522



00620

6/21/2022
5:38:22 PM

H-11 To SPOT 13- 14522



00621

6/21/2022
5:38:22 PM

H-11 To SPOT 13- 14522



00622

6/21/2022
5:38:22 PM

H-11 To SPOT 13- 14522



00623

6/21/2022
5:38:22 PM

H-11 To SPOT 13- 14522



00624

6/21/2022
5:38:22 PM

H-11 To SPOT 13- 14522



00625

6/21/2022
5:38:22 PM

H-11 To SPOT 13- 14522



00626

6/21/2022
5:38:22 PM

H-11 To SPOT 13- 14522



00627

6/21/2022
5:38:23 PM

H-11 To SPOT 13- 14522



00628

6/21/2022
5:38:23 PM

H-11 To SPOT 13- 14522



00629

6/21/2022
5:38:23 PM

H-11 To SPOT 13- 14522



00630

6/21/2022
5:38:23 PM

H-11 To SPOT 13- 14522



00631

6/21/2022
5:38:23 PM

H-11 To SPOT 13- 14522



00632

6/21/2022
5:38:23 PM

H-11 To SPOT 13- 14522



00633

6/21/2022
5:38:23 PM

H-11 To SPOT 13- 14522



00634

6/21/2022
5:38:24 PM

H-11 To SPOT 13- 14522



00635

6/21/2022
5:38:24 PM

H-11 To SPOT 13- 14522



00636

6/21/2022
5:38:24 PM

H-11 To SPOT 13- 14522



00637

6/21/2022
5:38:24 PM

H-11 To SPOT 13- 14522



00638

6/21/2022
5:38:24 PM

H-11 To SPOT 13- 14522



00639

6/21/2022
5:38:24 PM

H-11 To SPOT 13- 14522



00640

6/21/2022
5:38:24 PM

H-11 To SPOT 13- 14522



00641

6/21/2022
5:38:24 PM

H-11 To SPOT 13- 14522



00642

6/21/2022
5:38:25 PM

H-11 To SPOT 13- 14522



00643

6/21/2022
5:38:25 PM

H-11 To SPOT 13- 14522



00644

6/21/2022
5:38:25 PM

H-11 To SPOT 13- 14522



00645

6/21/2022
5:38:25 PM

H-11 To SPOT 13- 14522



00646

6/21/2022
5:38:25 PM

H-11 To SPOT 13- 14522



00647

6/21/2022
5:38:25 PM

H-11 To SPOT 13- 14522



00648

6/21/2022
5:38:25 PM

H-11 To SPOT 13- 14522



00649

6/21/2022
5:38:26 PM

H-11 To SPOT 13- 14522



00650

6/21/2022
5:38:26 PM

H-11 To SPOT 13- 14522



00651

6/21/2022
5:38:26 PM

H-11 To SPOT 13- 14522



00652

6/21/2022
5:38:26 PM

H-11 To SPOT 13- 14522



00653

6/21/2022
5:38:26 PM

H-11 To SPOT 13- 14522



00654

6/21/2022
5:38:26 PM

H-11 To SPOT 13- 14522



00655

6/21/2022
5:38:26 PM

H-11 To SPOT 13- 14522



00656

6/21/2022
5:38:26 PM

H-11 To SPOT 13- 14522



00657

6/21/2022
5:38:27 PM

H-11 To SPOT 13- 14522



00658

6/21/2022
5:38:27 PM

H-11 To SPOT 13- 14522



00659

6/21/2022
5:38:27 PM

H-11 To SPOT 13- 14522



00660

6/21/2022
5:38:27 PM

H-11 To SPOT 13- 14522



00661

6/21/2022
5:38:27 PM

H-11 To SPOT 13- 14522



00662

6/21/2022
5:38:27 PM

H-11 To SPOT 13- 14522



00663

6/21/2022
5:38:27 PM

H-11 To SPOT 13- 14522



00664

6/21/2022
5:38:28 PM

H-11 To SPOT 13- 14522



00665

6/21/2022
5:38:28 PM

H-11 To SPOT 13- 14522



00666

6/21/2022
5:38:28 PM

H-11 To SPOT 13- 14522



00667

6/21/2022
5:38:28 PM

H-11 To SPOT 13- 14522



00668

6/21/2022
5:38:28 PM

H-11 To SPOT 13- 14522



00669

6/21/2022
5:38:28 PM

H-11 To SPOT 13- 14522



00670

6/21/2022
5:38:28 PM

H-11 To SPOT 13- 14522



00671

6/21/2022
5:38:28 PM

H-11 To SPOT 13- 14522



00672

6/21/2022
5:38:29 PM

H-11 To SPOT 13- 14522



00673

6/21/2022
5:38:29 PM

H-11 To SPOT 13- 14522



00674

6/21/2022
5:38:29 PM

H-11 To SPOT 13- 14522



00675

6/21/2022
5:38:29 PM

H-11 To SPOT 13- 14522



00676

6/21/2022
5:38:29 PM

H-11 To SPOT 13- 14522



00677

6/21/2022
5:38:29 PM

H-11 To SPOT 13- 14522



00678

6/21/2022
5:38:29 PM

H-11 To SPOT 13- 14522



00679

6/21/2022
5:38:30 PM

H-11 To SPOT 13- 14522



00680

6/21/2022
5:38:30 PM

H-11 To SPOT 13- 14522



00681

6/21/2022
5:38:30 PM

H-11 To SPOT 13- 14522



00682

6/21/2022
5:38:30 PM

H-11 To SPOT 13- 14522



00683

6/21/2022
5:38:30 PM

H-11 To SPOT 13- 14522



00684

6/21/2022
5:38:30 PM

H-11 To SPOT 13- 14522



00685

6/21/2022
5:38:30 PM

H-11 To SPOT 13- 14522



6/21/2022
5:38:30 PM

H-11 To SPOT 13- 14522



6/21/2022
5:38:31 PM

H-11 To SPOT 13- 14522



00688

6/21/2022
5:38:31 PM

H-11 To SPOT 13- 14522



00689

6/21/2022
5:38:31 PM

H-11 To SPOT 13- 14522



00690

6/21/2022
5:38:31 PM

H-11 To SPOT 13- 14522



00691

6/21/2022
5:38:31 PM

H-11 To SPOT 13- 14522



00692

6/21/2022
5:38:31 PM

H-11 To SPOT 13- 14522



00693

6/21/2022
5:38:31 PM

H-11 To SPOT 13- 14522



00694

6/21/2022
5:38:32 PM

H-11 To SPOT 13- 14522



00695

6/21/2022
5:38:32 PM

H-11 To SPOT 13- 14522



00696

6/21/2022
5:38:32 PM

H-11 To SPOT 13- 14522



00697

6/21/2022
5:38:32 PM

H-11 To SPOT 13- 14522



00698

6/21/2022
5:38:32 PM

H-11 To SPOT 13- 14522



00699

6/21/2022
5:38:32 PM

H-11 To SPOT 13- 14522



00700

6/21/2022
5:38:32 PM

H-11 To SPOT 13- 14522



00701

6/21/2022
5:38:32 PM

H-11 To SPOT 13- 14522



00702

6/21/2022
5:38:33 PM

H-11 To SPOT 13- 14522



00703

6/21/2022
5:38:33 PM

H-11 To SPOT 13- 14522



00704

6/21/2022
5:38:33 PM

H-11 To SPOT 13- 14522



00705

6/21/2022
5:38:33 PM

H-11 To SPOT 13- 14522



00706

6/21/2022
5:38:33 PM

H-11 To SPOT 13- 14522



00707

6/21/2022
5:38:33 PM

H-11 To SPOT 13- 14522



00708

6/21/2022
5:38:33 PM

H-11 To SPOT 13- 14522



00709

6/21/2022
5:38:34 PM

H-11 To SPOT 13- 14522



00710

6/21/2022
5:38:34 PM

H-11 To SPOT 13- 14522



00711

6/21/2022
5:38:34 PM

H-11 To SPOT 13- 14522



00712

6/21/2022
5:38:34 PM

H-11 To SPOT 13- 14522



00713

6/21/2022
5:38:34 PM

H-11 To SPOT 13- 14522



00714

6/21/2022
5:38:34 PM

H-11 To SPOT 13- 14522



00715

6/21/2022
5:38:34 PM

H-11 To SPOT 13- 14522



00716

6/21/2022
5:38:34 PM

H-11 To SPOT 13- 14522



00717

6/21/2022
5:38:35 PM

H-11 To SPOT 13- 14522



00718

6/21/2022
5:38:35 PM

H-11 To SPOT 13- 14522



00719

6/21/2022
5:38:35 PM

H-11 To SPOT 13- 14522



00720

6/21/2022
5:38:35 PM

H-11 To SPOT 13- 14522



00721

6/21/2022
5:38:35 PM

H-11 To SPOT 13- 14522



00722

6/21/2022
5:38:35 PM

H-11 To SPOT 13- 14522



00723

6/21/2022
5:38:35 PM

H-11 To SPOT 13- 14522



00724

6/21/2022
5:38:36 PM

H-11 To SPOT 13- 14522



00725

6/21/2022
5:38:36 PM

H-11 To SPOT 13- 14522



00726

6/21/2022
5:38:36 PM

H-11 To SPOT 13- 14522



00727

6/21/2022
5:38:36 PM

H-11 To SPOT 13- 14522



00728

6/21/2022
5:38:36 PM

H-11 To SPOT 13- 14522



00729

6/21/2022
5:38:36 PM

H-11 To SPOT 13- 14522



00730

6/21/2022
5:38:36 PM

H-11 To SPOT 13- 14522



00731

6/21/2022
5:38:36 PM

H-11 To SPOT 13- 14522



00732

6/21/2022
5:38:37 PM

H-11 To SPOT 13- 14522



00733

6/21/2022
5:38:37 PM

H-11 To SPOT 13- 14522



00734

6/21/2022
5:38:37 PM

H-11 To SPOT 13- 14522



00735

6/21/2022
5:38:37 PM

H-11 To SPOT 13- 14522



00736

6/21/2022
5:38:37 PM

H-11 To SPOT 13- 14522



00737

6/21/2022
5:38:37 PM

H-11 To SPOT 13- 14522



00738

6/21/2022
5:38:37 PM

H-11 To SPOT 13- 14522



00739

6/21/2022
5:38:38 PM

H-11 To SPOT 13- 14522



00740

6/21/2022
5:38:38 PM

H-11 To SPOT 13- 14522



00741

6/21/2022
5:38:38 PM

H-11 To SPOT 13- 14522



00742

6/21/2022
5:38:38 PM

H-11 To SPOT 13- 14522



00743

6/21/2022
5:38:38 PM

H-11 To SPOT 13- 14522



00744

6/21/2022
5:38:38 PM

H-11 To SPOT 13- 14522



00745

6/21/2022
5:38:38 PM

H-11 To SPOT 13- 14522



00746

6/21/2022
5:38:38 PM

H-11 To SPOT 13- 14522



00747

6/21/2022
5:38:39 PM

H-11 To SPOT 13- 14522



00748

6/21/2022
5:38:39 PM

H-11 To SPOT 13- 14522



00749

6/21/2022
5:38:39 PM

H-11 To SPOT 13- 14522



00750

6/21/2022
5:38:39 PM

H-11 To SPOT 13- 14522



00751

6/21/2022
5:38:39 PM

H-11 To SPOT 13- 14522



00752

6/21/2022
5:38:39 PM

H-11 To SPOT 13- 14522



00753

6/21/2022
5:38:39 PM

H-11 To SPOT 13- 14522



00754

6/21/2022
5:38:40 PM

H-11 To SPOT 13- 14522



00755

6/21/2022
5:38:40 PM

H-11 To SPOT 13- 14522



00756

6/21/2022
5:38:40 PM

H-11 To SPOT 13- 14522



00757

6/21/2022
5:38:40 PM

H-11 To SPOT 13- 14522



00758

6/21/2022
5:38:40 PM

H-11 To SPOT 13- 14522



00759

6/21/2022
5:38:40 PM

H-11 To SPOT 13- 14522



00760

6/21/2022
5:38:40 PM

H-11 To SPOT 13- 14522



00761

6/21/2022
5:38:40 PM

H-11 To SPOT 13- 14522



00762

6/21/2022
5:38:41 PM

H-11 To SPOT 13- 14522



00763

6/21/2022
5:38:41 PM

H-11 To SPOT 13- 14522



00764

6/21/2022
5:38:41 PM

H-11 To SPOT 13- 14522



00765

6/21/2022
5:38:41 PM

H-11 To SPOT 13- 14522



00766

6/21/2022
5:38:41 PM

H-11 To SPOT 13- 14522



00767

6/21/2022
5:38:41 PM

H-11 To SPOT 13- 14522



00768

6/21/2022
5:38:41 PM

H-11 To SPOT 13- 14522



00769

6/21/2022
5:38:42 PM

H-11 To SPOT 13- 14522



6/21/2022
5:38:42 PM

H-11 To SPOT 13- 14522



6/21/2022
5:38:42 PM

H-11 To SPOT 13- 14522



00772

6/21/2022
5:38:42 PM

H-11 To SPOT 13- 14522



00773

6/21/2022
5:38:42 PM

H-11 To SPOT 13- 14522



00774

6/21/2022
5:38:42 PM

H-11 To SPOT 13- 14522



00775

6/21/2022
5:38:42 PM

H-11 To SPOT 13- 14522



00776

6/21/2022
5:38:42 PM

H-11 To SPOT 13- 14522



00777

6/21/2022
5:38:43 PM

H-11 To SPOT 13- 14522



00778

6/21/2022
5:38:43 PM

H-11 To SPOT 13- 14522



00779

6/21/2022
5:38:43 PM

H-11 To SPOT 13- 14522



6/21/2022
5:38:43 PM

H-11 To SPOT 13- 14522



6/21/2022
5:38:43 PM

H-11 To SPOT 13- 14522



00782

6/21/2022
5:38:43 PM

H-11 To SPOT 13- 14522



00783

6/21/2022
5:38:43 PM

H-11 To SPOT 13- 14522



00784

6/21/2022
5:38:44 PM

H-11 To SPOT 13- 14522



00785

6/21/2022
5:38:44 PM

H-11 To SPOT 13- 14522



00786

6/21/2022
5:38:44 PM

H-11 To SPOT 13- 14522



00787

6/21/2022
5:38:44 PM

H-11 To SPOT 13- 14522



00788

6/21/2022
5:38:44 PM

H-11 To SPOT 13- 14522



00789

6/21/2022
5:38:44 PM

H-11 To SPOT 13- 14522



00790

6/21/2022
5:38:44 PM

H-11 To SPOT 13- 14522



00791

6/21/2022
5:38:44 PM

H-11 To SPOT 13- 14522



6/21/2022
5:38:45 PM

H-11 To SPOT 13- 14522



6/21/2022
5:38:45 PM

H-11 To SPOT 13- 14522



6/21/2022
5:38:45 PM

H-11 To SPOT 13- 14522



6/21/2022
5:38:45 PM

H-11 To SPOT 13- 14522



00796

6/21/2022
5:38:45 PM

H-11 To SPOT 13- 14522



00797

6/21/2022
5:38:45 PM

H-11 To SPOT 13- 14522



00798

6/21/2022
5:38:45 PM

H-11 To SPOT 13- 14522



00799

6/21/2022
5:38:46 PM

H-11 To SPOT 13- 14522



00800

6/21/2022
5:38:46 PM

H-11 To SPOT 13- 14522



00801

6/21/2022
5:38:46 PM

H-11 To SPOT 13- 14522



00802

6/21/2022
5:38:46 PM

H-11 To SPOT 13- 14522



00803

6/21/2022
5:38:46 PM

H-11 To SPOT 13- 14522



00804

6/21/2022
5:38:46 PM

H-11 To SPOT 13- 14522



00805

6/21/2022
5:38:46 PM

H-11 To SPOT 13- 14522



00806

6/21/2022
5:38:46 PM

H-11 To SPOT 13- 14522



00807

6/21/2022
5:38:47 PM

H-11 To SPOT 13- 14522



00808

6/21/2022
5:38:47 PM

H-11 To SPOT 13- 14522



00809

6/21/2022
5:38:47 PM

H-11 To SPOT 13- 14522



6/21/2022
5:38:47 PM

H-11 To SPOT 13- 14522



6/21/2022
5:38:47 PM

H-11 To SPOT 13- 14522



00812

6/21/2022
5:38:47 PM

H-11 To SPOT 13- 14522



00813

6/21/2022
5:38:47 PM

H-11 To SPOT 13- 14522



00814

6/21/2022
5:38:48 PM

H-11 To SPOT 13- 14522



00815

6/21/2022
5:38:48 PM

H-11 To SPOT 13- 14522



00816

6/21/2022
5:38:48 PM

H-11 To SPOT 13- 14522



00817

6/21/2022
5:38:48 PM

H-11 To SPOT 13- 14522



00818

6/21/2022
5:38:48 PM

H-11 To SPOT 13- 14522



00819

6/21/2022
5:38:48 PM

H-11 To SPOT 13- 14522



00820

6/21/2022
5:38:48 PM

H-11 To SPOT 13- 14522



00821

6/21/2022
5:38:49 PM

H-11 To SPOT 13- 14522



6/21/2022
5:38:49 PM

H-11 To SPOT 13- 14522



6/21/2022
5:38:49 PM

H-11 To SPOT 13- 14522



00824

6/21/2022
5:38:49 PM

H-11 To SPOT 13- 14522



00825

6/21/2022
5:38:49 PM

H-11 To SPOT 13- 14522



00826

6/21/2022
5:38:49 PM

H-11 To SPOT 13- 14522



00827

6/21/2022
5:38:49 PM

H-11 To SPOT 13- 14522



00828

6/21/2022
5:38:50 PM

H-11 To SPOT 13- 14522



00829

6/21/2022
5:38:50 PM

H-11 To SPOT 13- 14522



00830

6/21/2022
5:38:50 PM

H-11 To SPOT 13- 14522



00831

6/21/2022
5:38:50 PM

H-11 To SPOT 13- 14522



00832

6/21/2022
5:38:50 PM

H-11 To SPOT 13- 14522



00833

6/21/2022
5:38:50 PM

H-11 To SPOT 13- 14522



00834

6/21/2022
5:38:50 PM

H-11 To SPOT 13- 14522



00835

6/21/2022
5:38:50 PM

H-11 To SPOT 13- 14522



00836

6/21/2022
5:38:51 PM

H-11 To SPOT 13- 14522



00837

6/21/2022
5:38:51 PM

H-11 To SPOT 13- 14522



00838

6/21/2022
5:38:51 PM

H-11 To SPOT 13- 14522



00839

6/21/2022
5:38:51 PM

H-11 To SPOT 13- 14522



00840

6/21/2022
5:38:51 PM

H-11 To SPOT 13- 14522



00841

6/21/2022
5:38:51 PM

H-11 To SPOT 13- 14522



00842

6/21/2022
5:38:51 PM

H-11 To SPOT 13- 14522



00843

6/21/2022
5:38:52 PM

H-11 To SPOT 13- 14522



00844

6/21/2022
5:38:52 PM

H-11 To SPOT 13- 14522



00845

6/21/2022
5:38:52 PM

H-11 To SPOT 13- 14522



00846

6/21/2022
5:38:52 PM

H-11 To SPOT 13- 14522



00847

6/21/2022
5:38:52 PM

H-11 To SPOT 13- 14522



00848

6/21/2022
5:38:52 PM

H-11 To SPOT 13- 14522



00849

6/21/2022
5:38:52 PM

H-11 To SPOT 13- 14522



00850

6/21/2022
5:38:52 PM

H-11 To SPOT 13- 14522



00851

ATTACHMENT 11: "PASSENGER" CAMERA IMAGE SEQUENCE



00001



00002

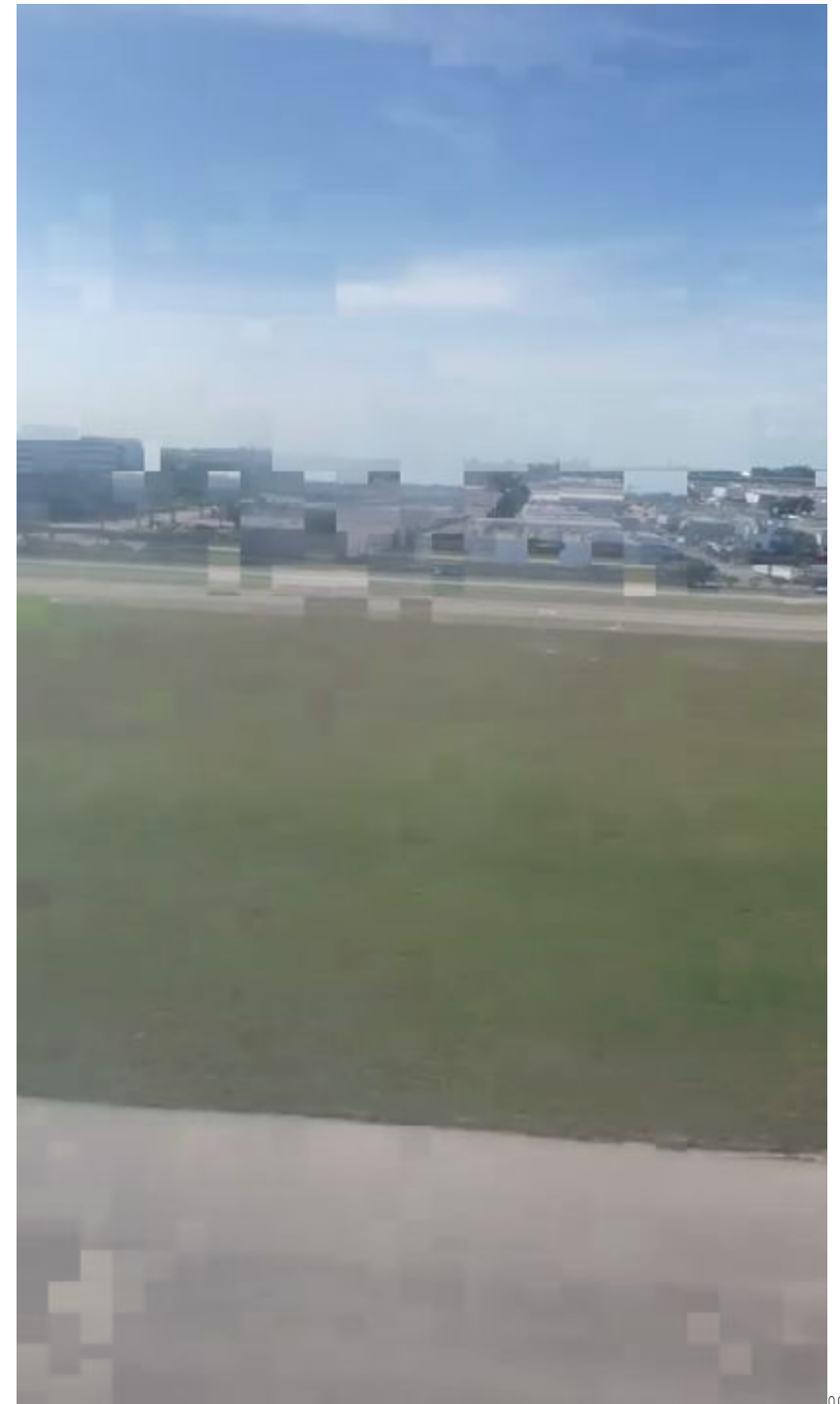

00003



00004



00005



00006



00007



00008



00009



00010



00011

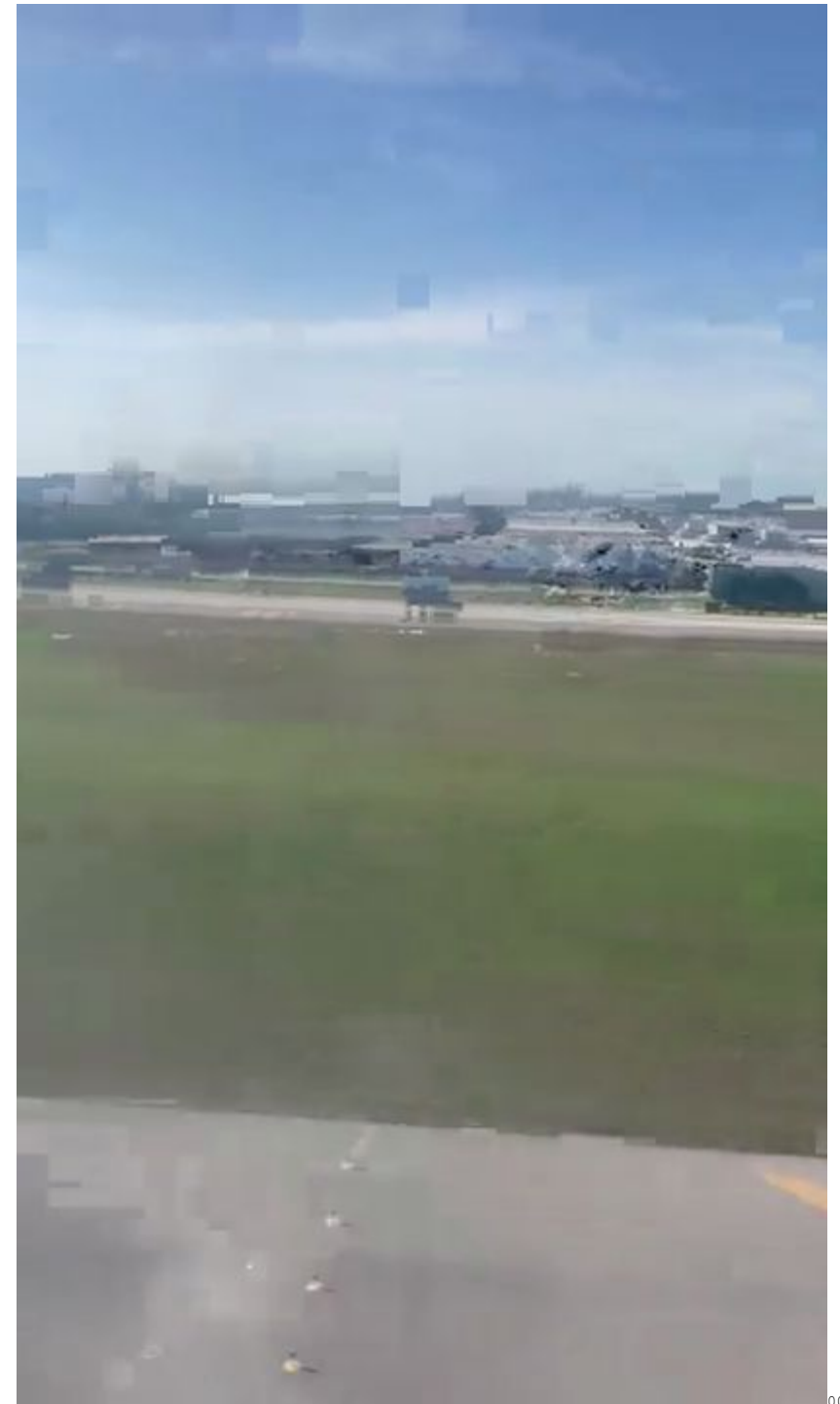

00012



00013



00014

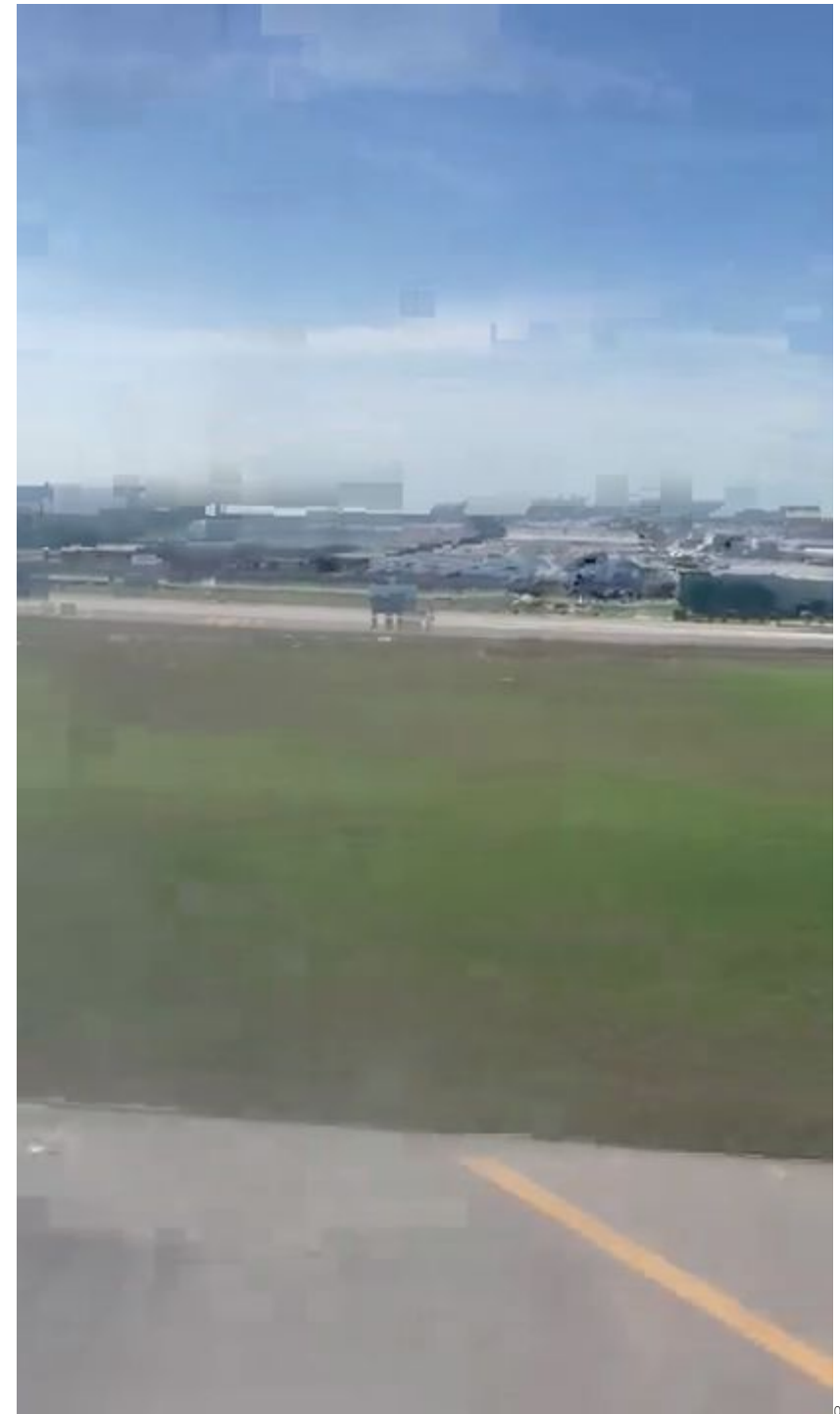

00015



00016

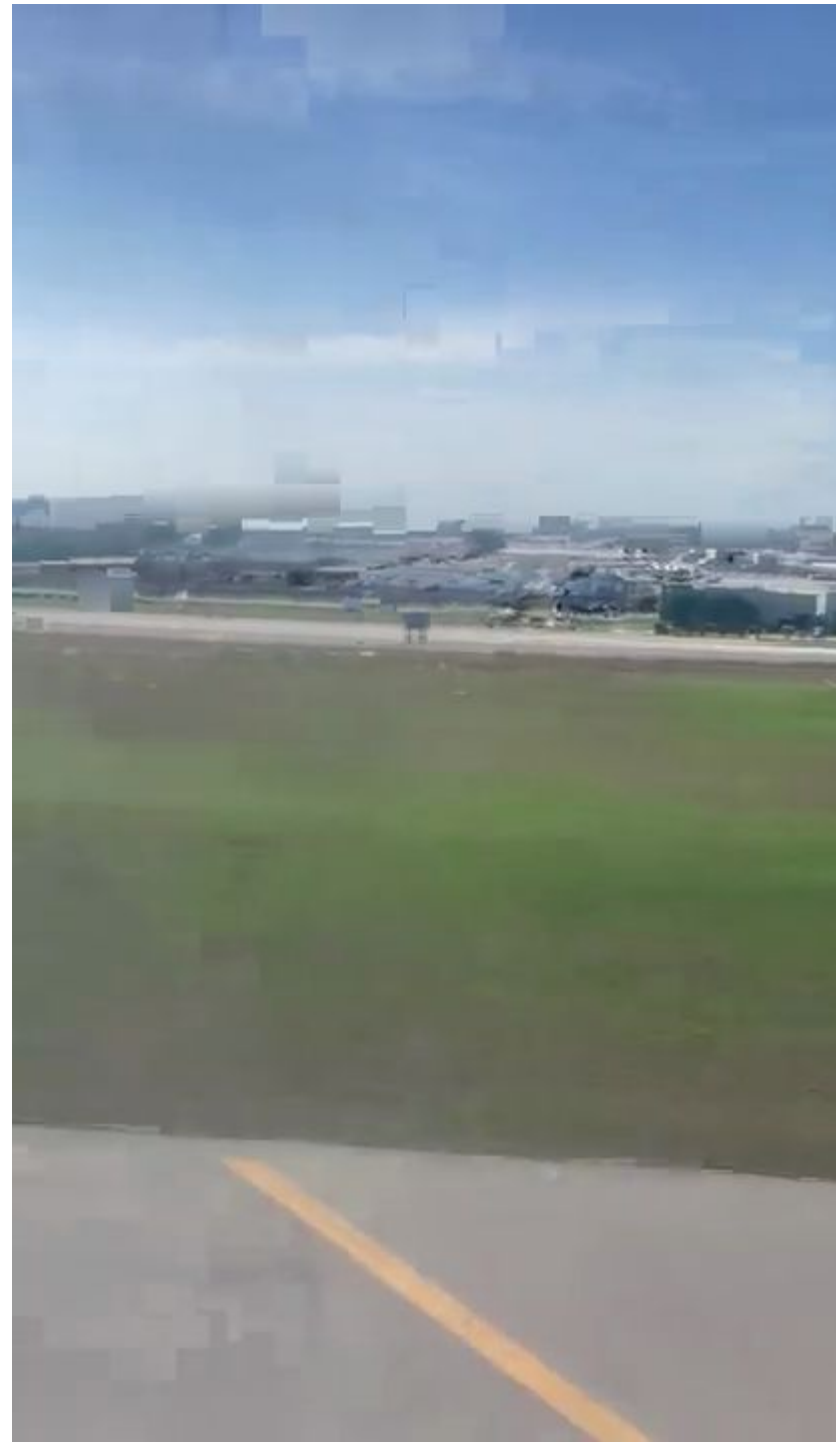

00017

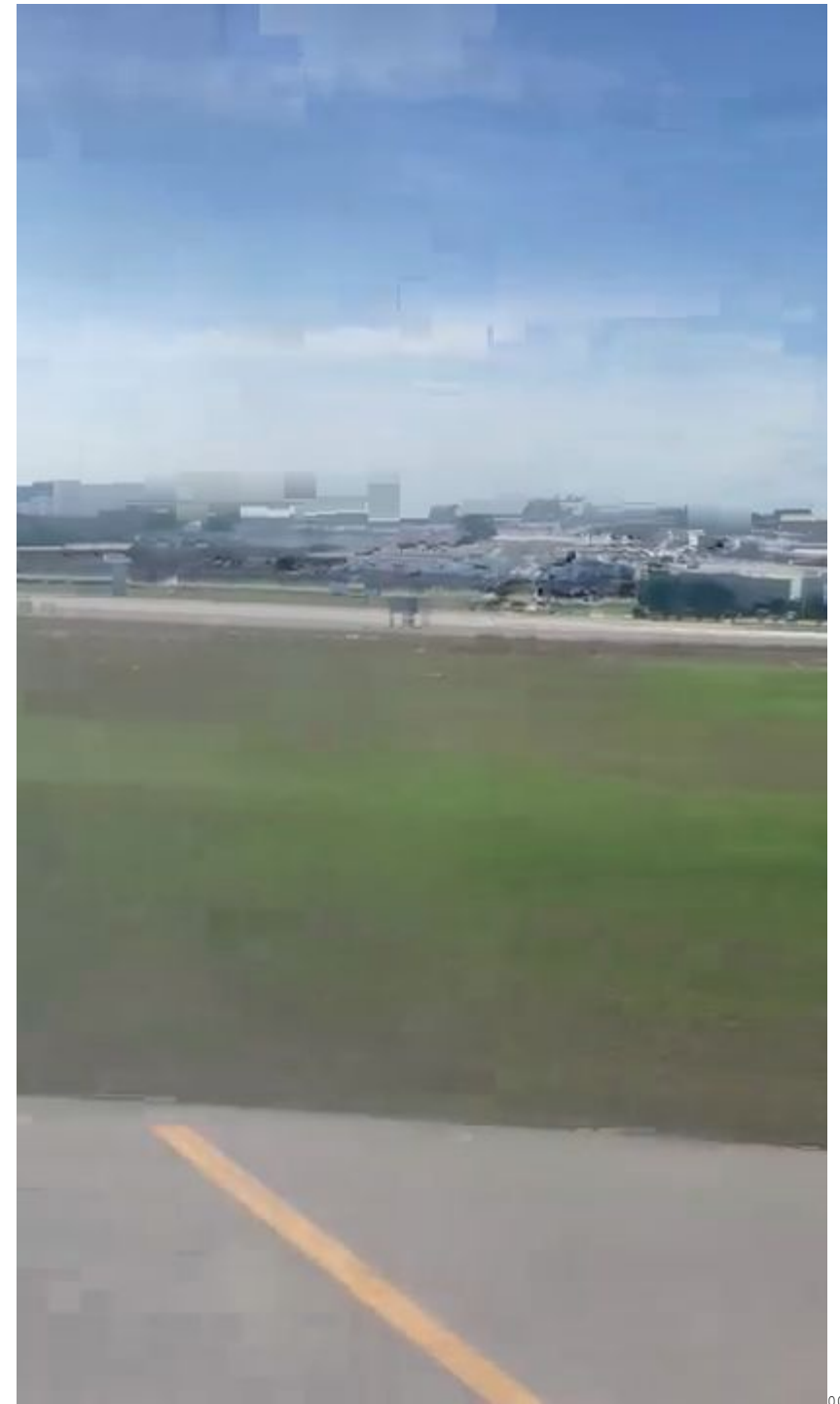

00018



00019



00020



00021



00022



00023



00024



00025



00026

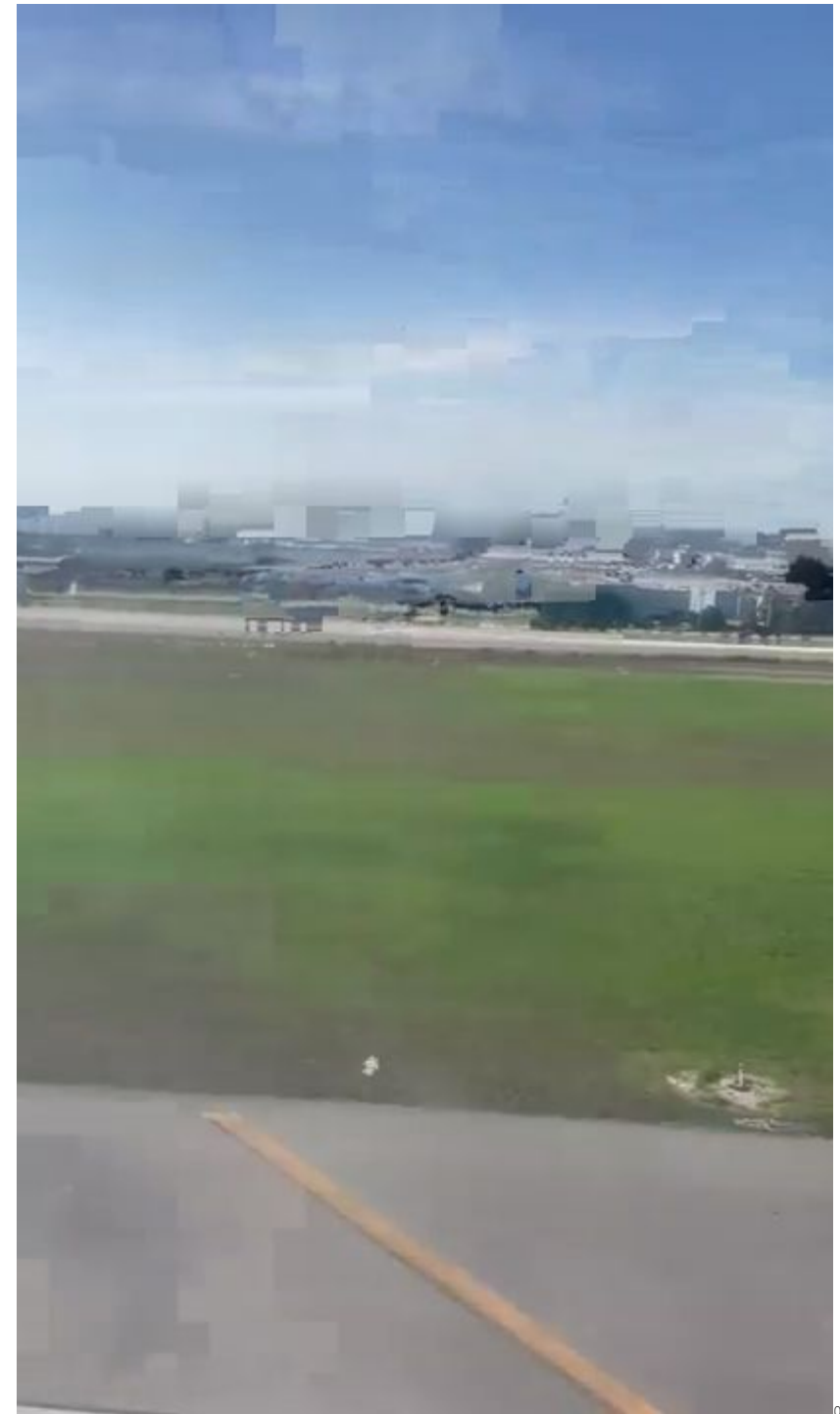

00027

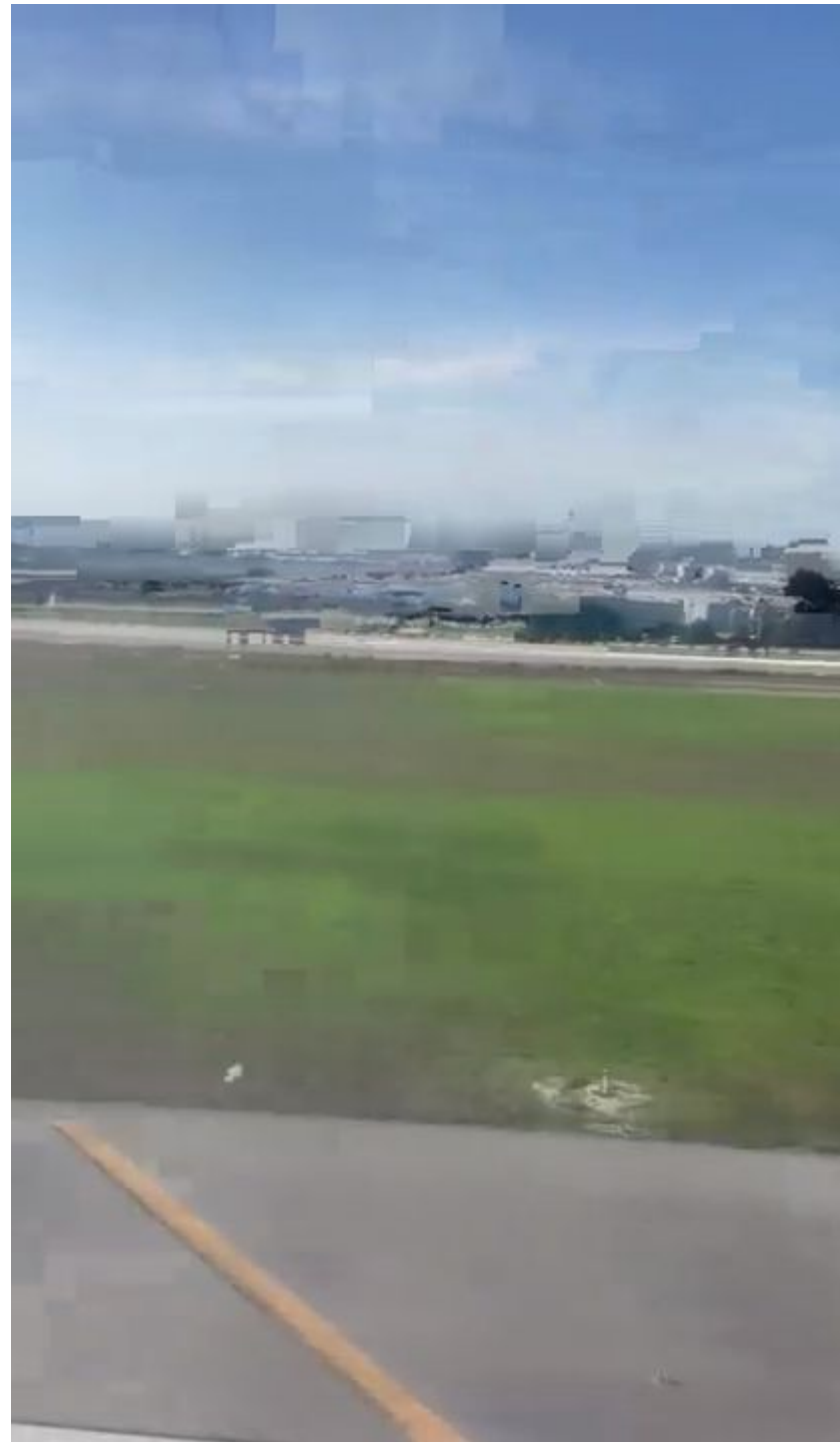

00028



00029



00030



00031



00032



00033



00034



00035

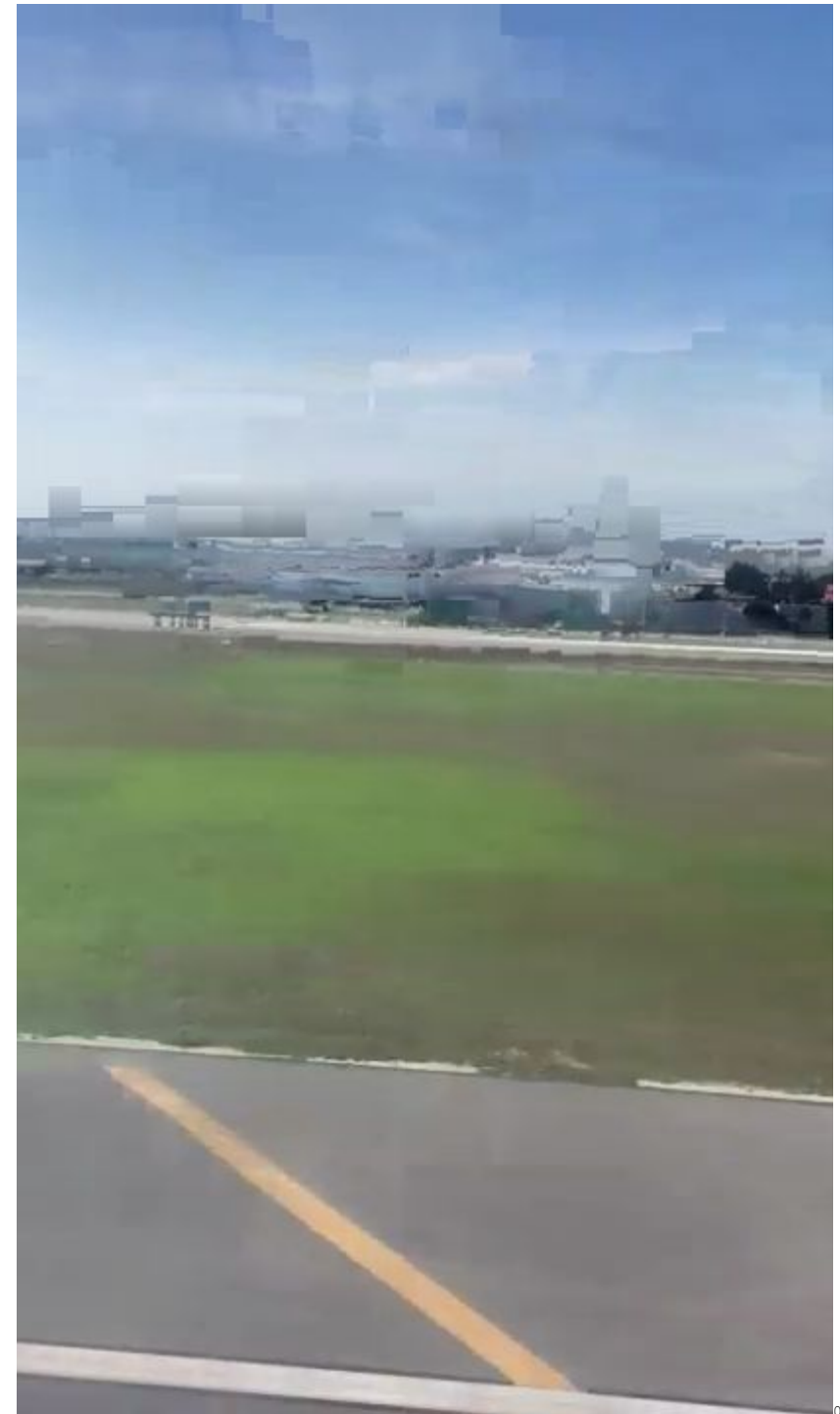

00036



00037



00038



00039



00040



00041



00042



00043



00044

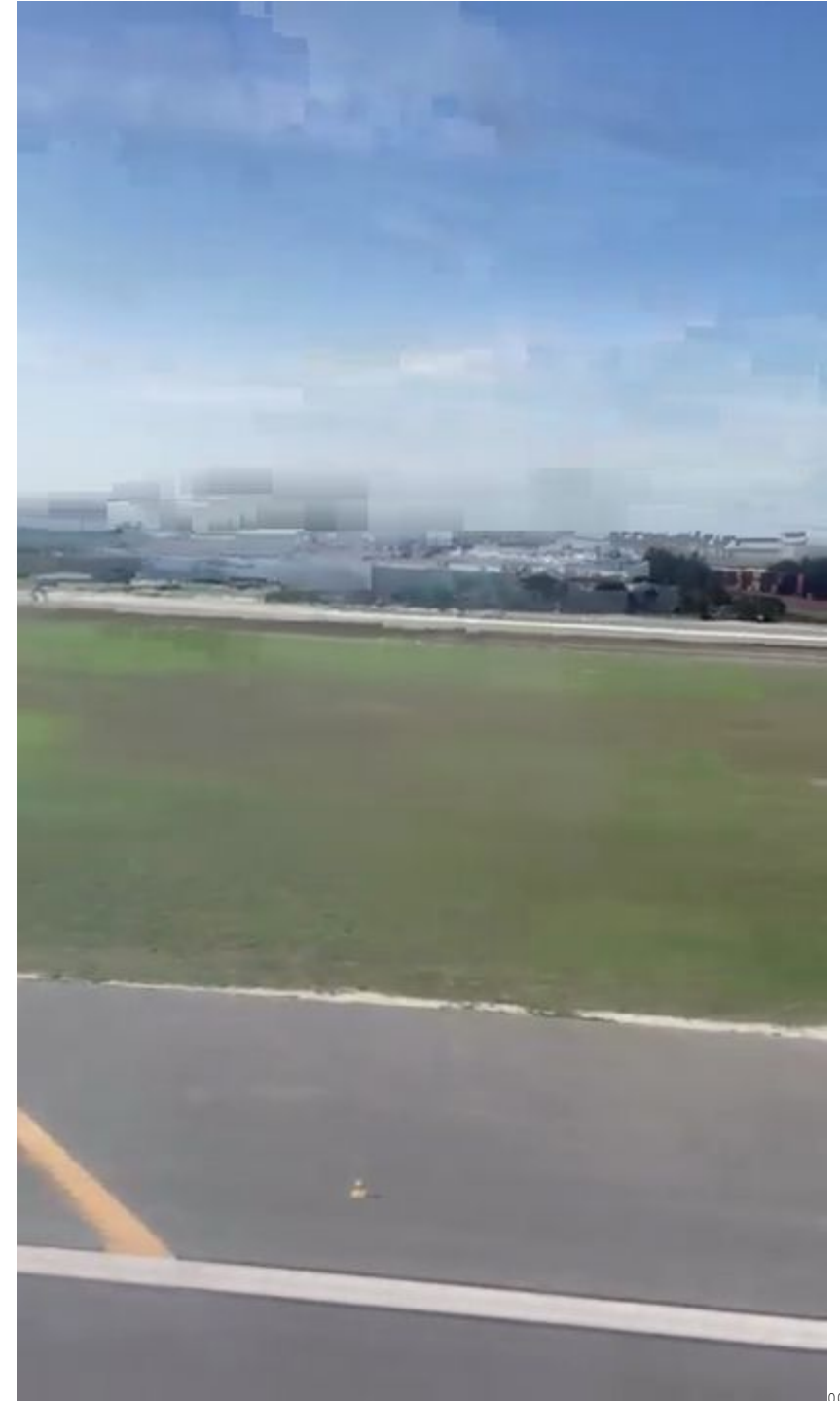

00045



00046



00047



00048



00049



00050

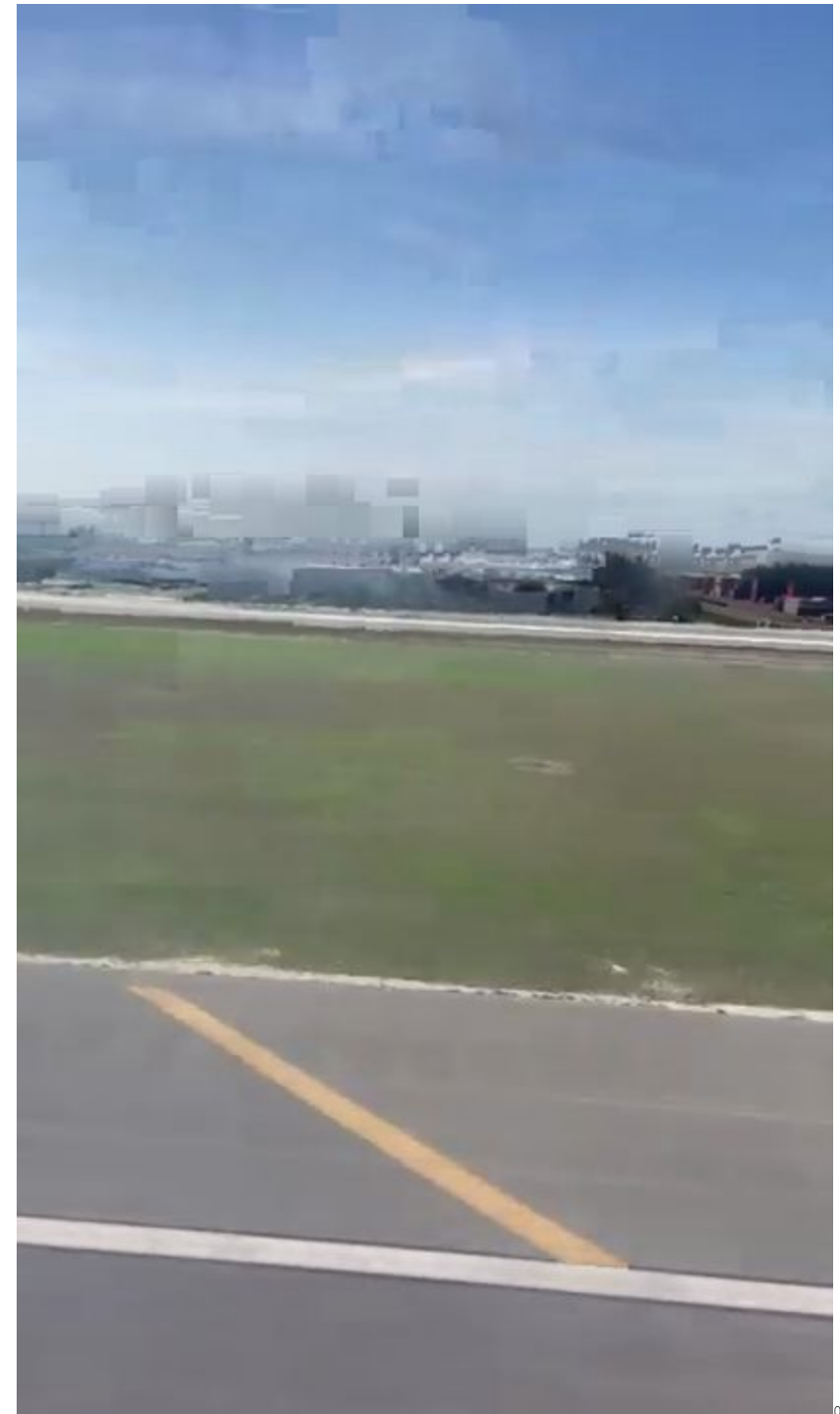

00051

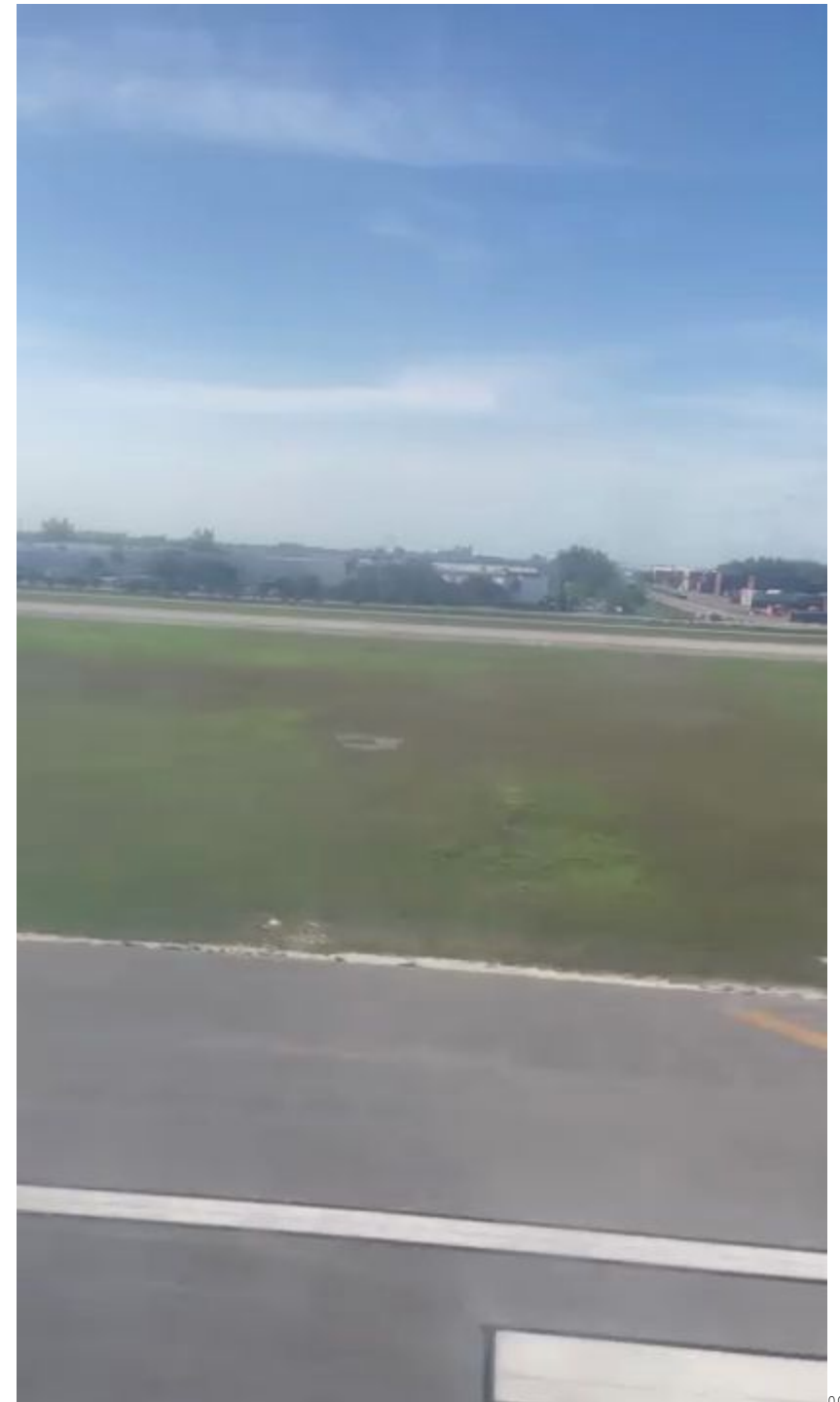



00055

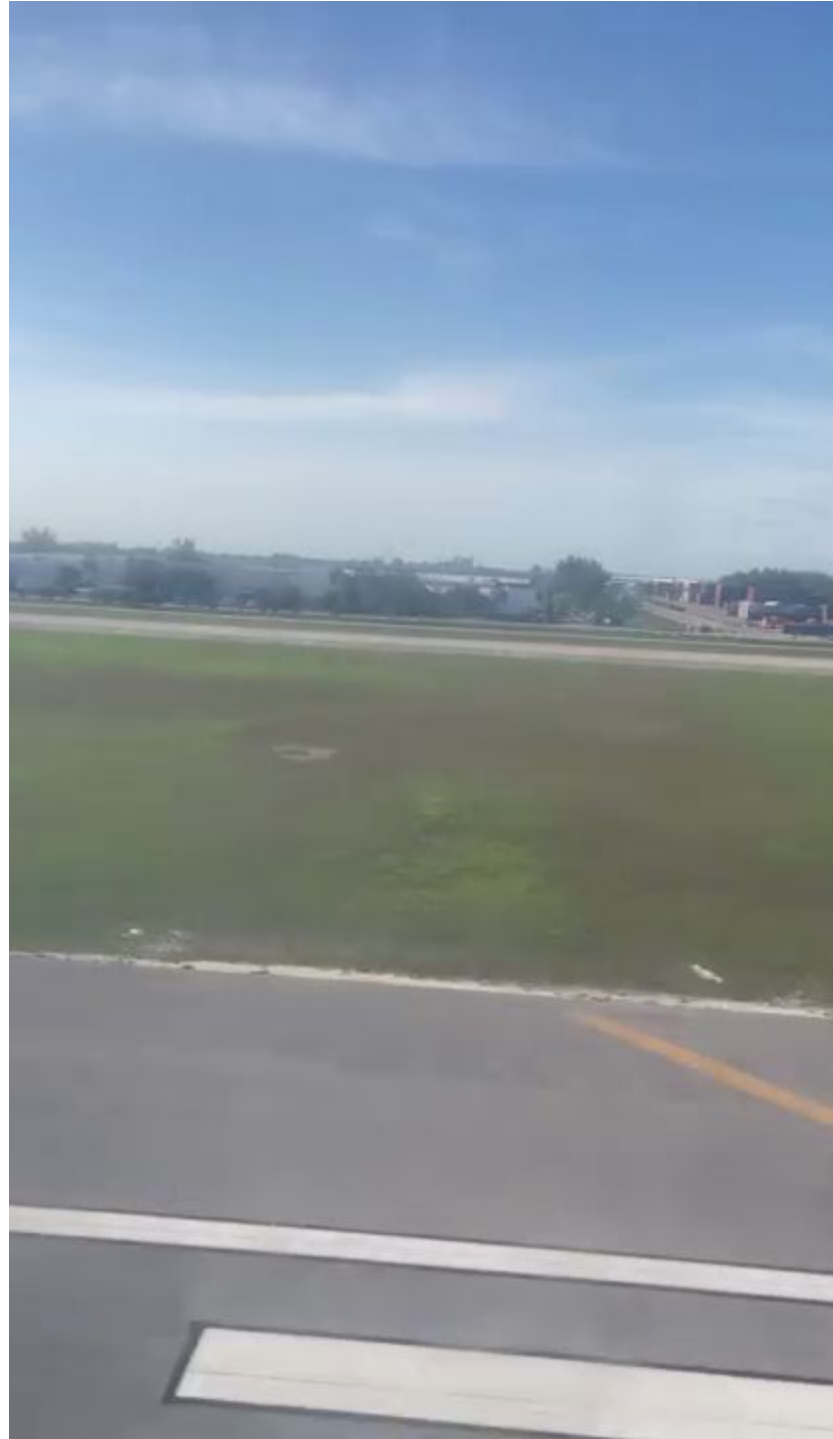

00056

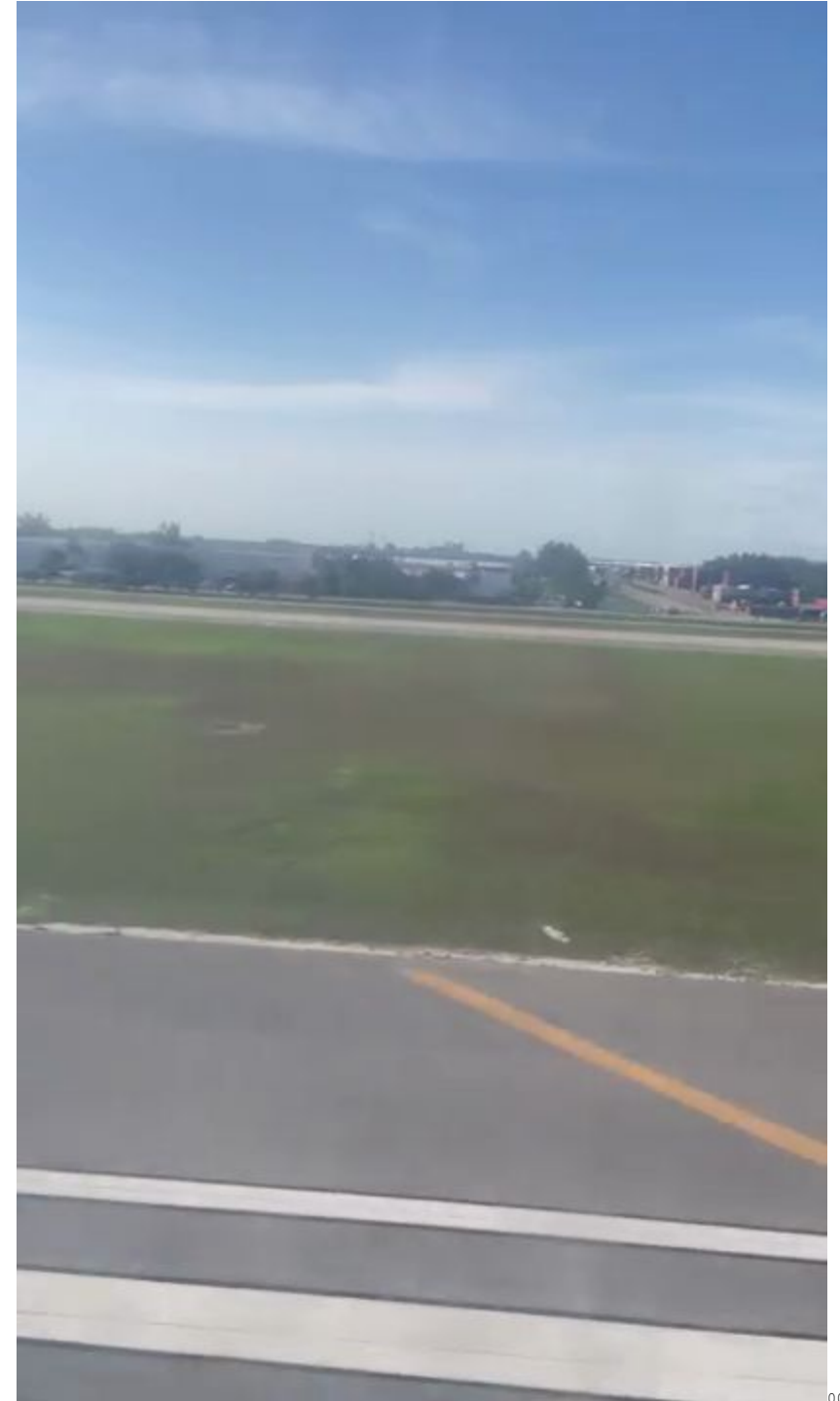

00057



00058



00059

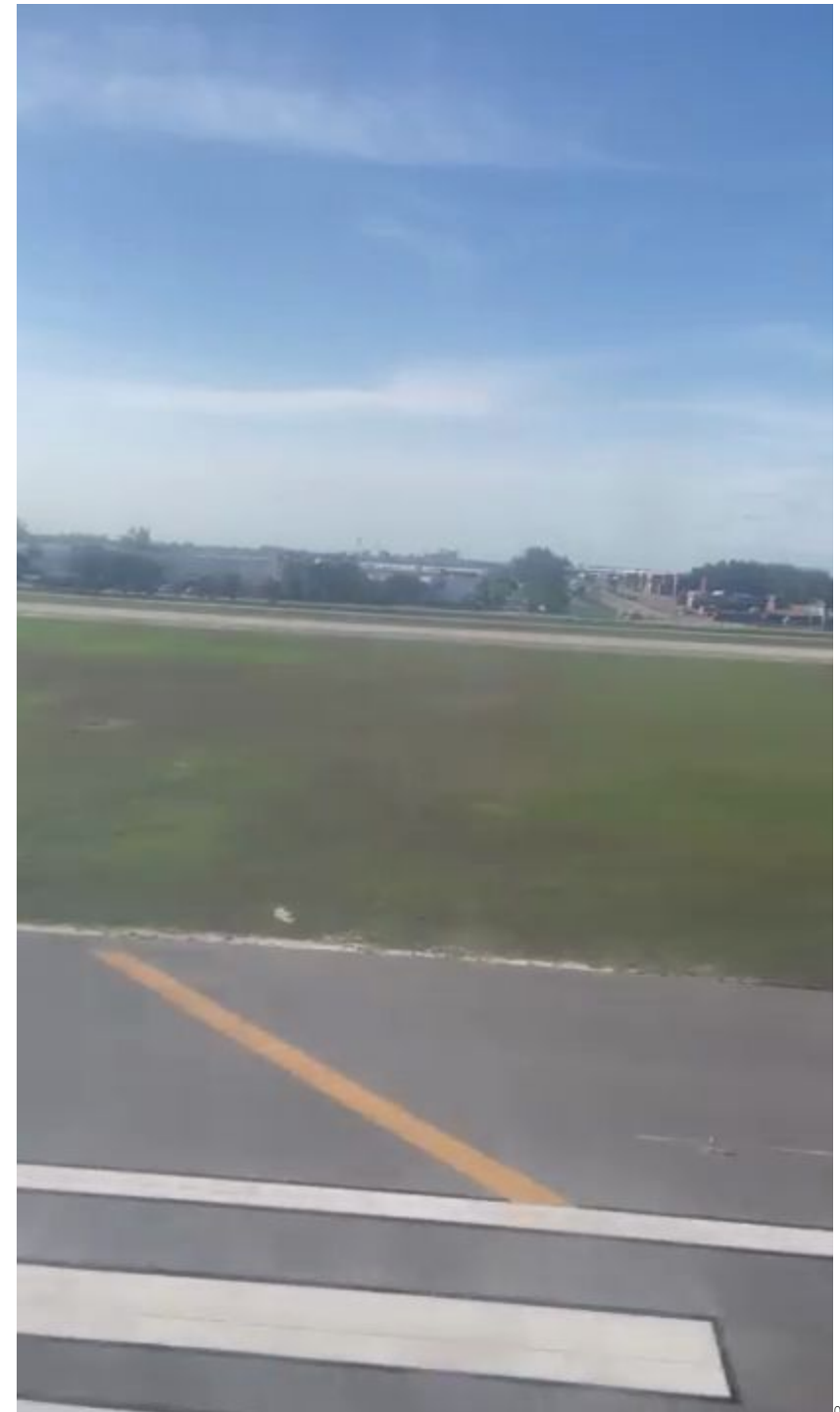

00060



00061



00062



00063



00064



00065



00066



00067



00068



00069



00070



00071



00072



00073



00074



00075



00076



00077

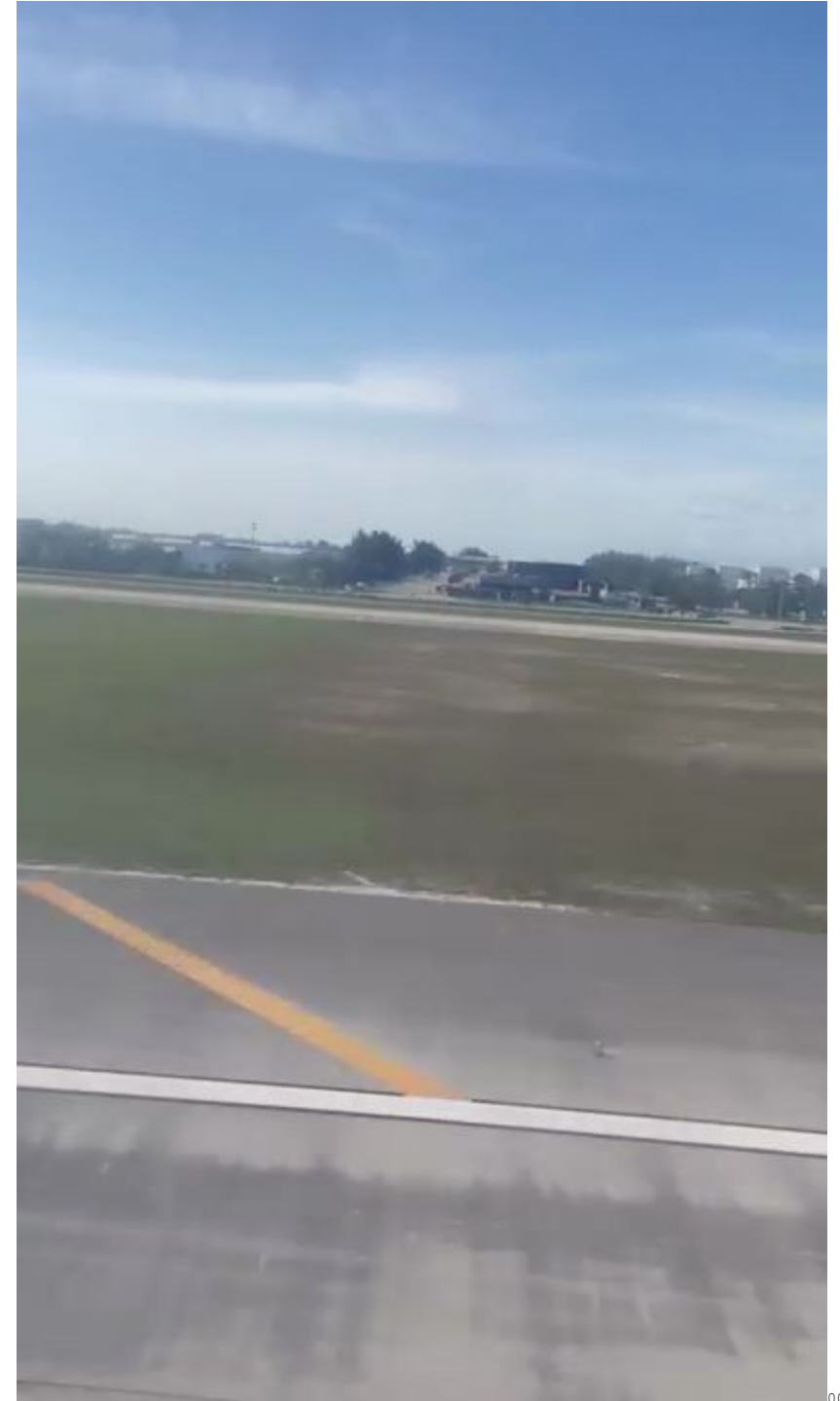

00078



00079



00080



00081



00082



00083

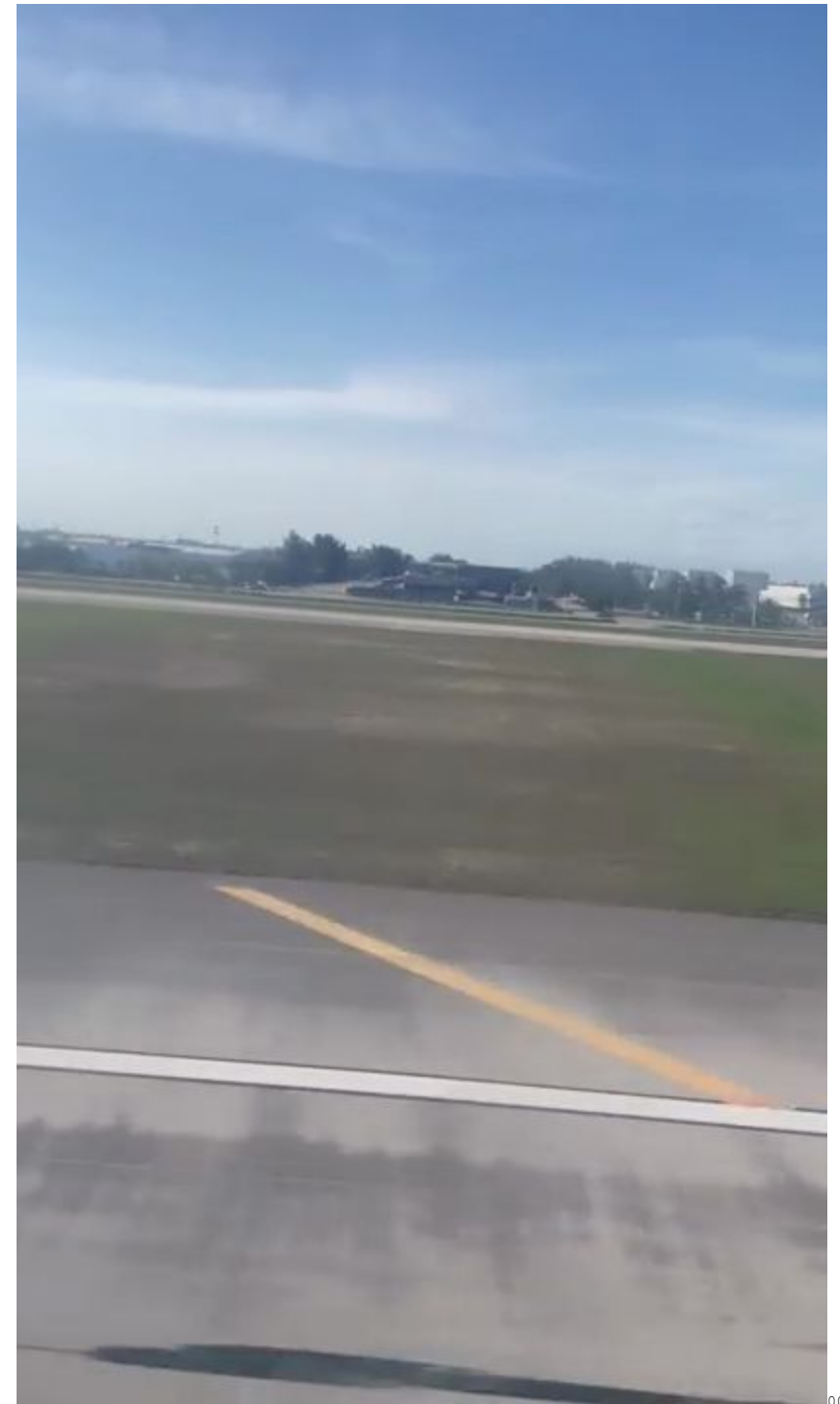

00084



00085



00086

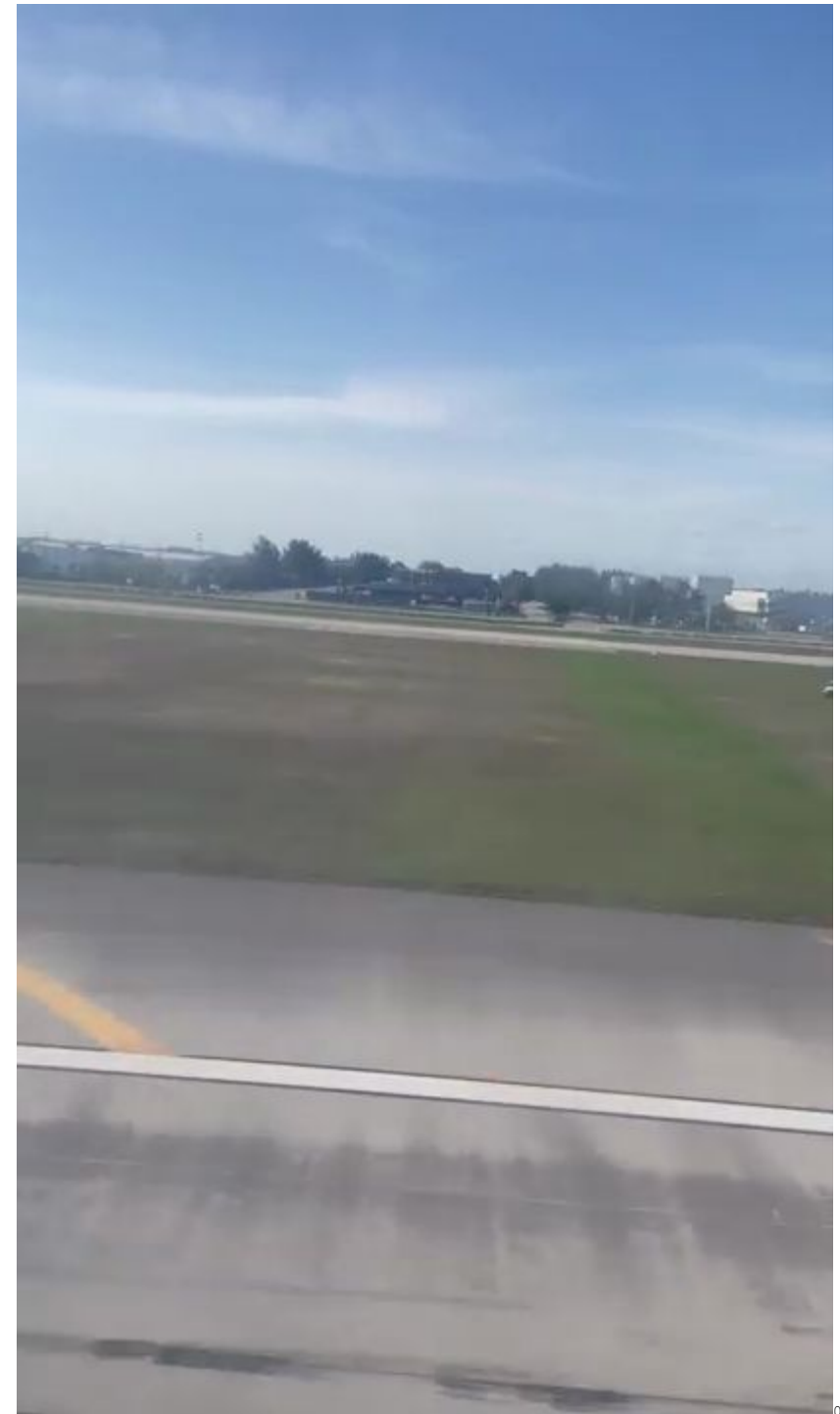

00087



00088



00089

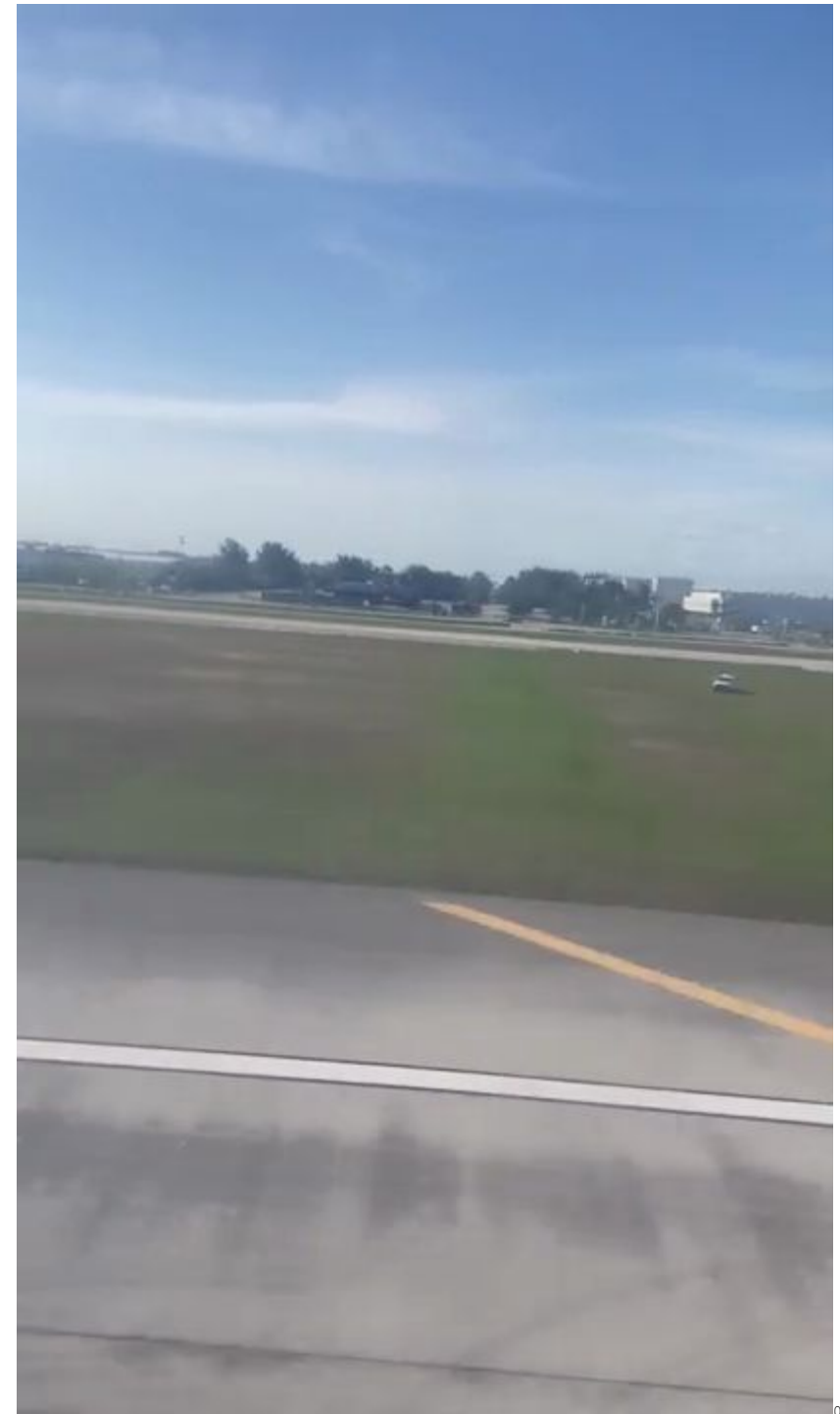

00090



00091



00092

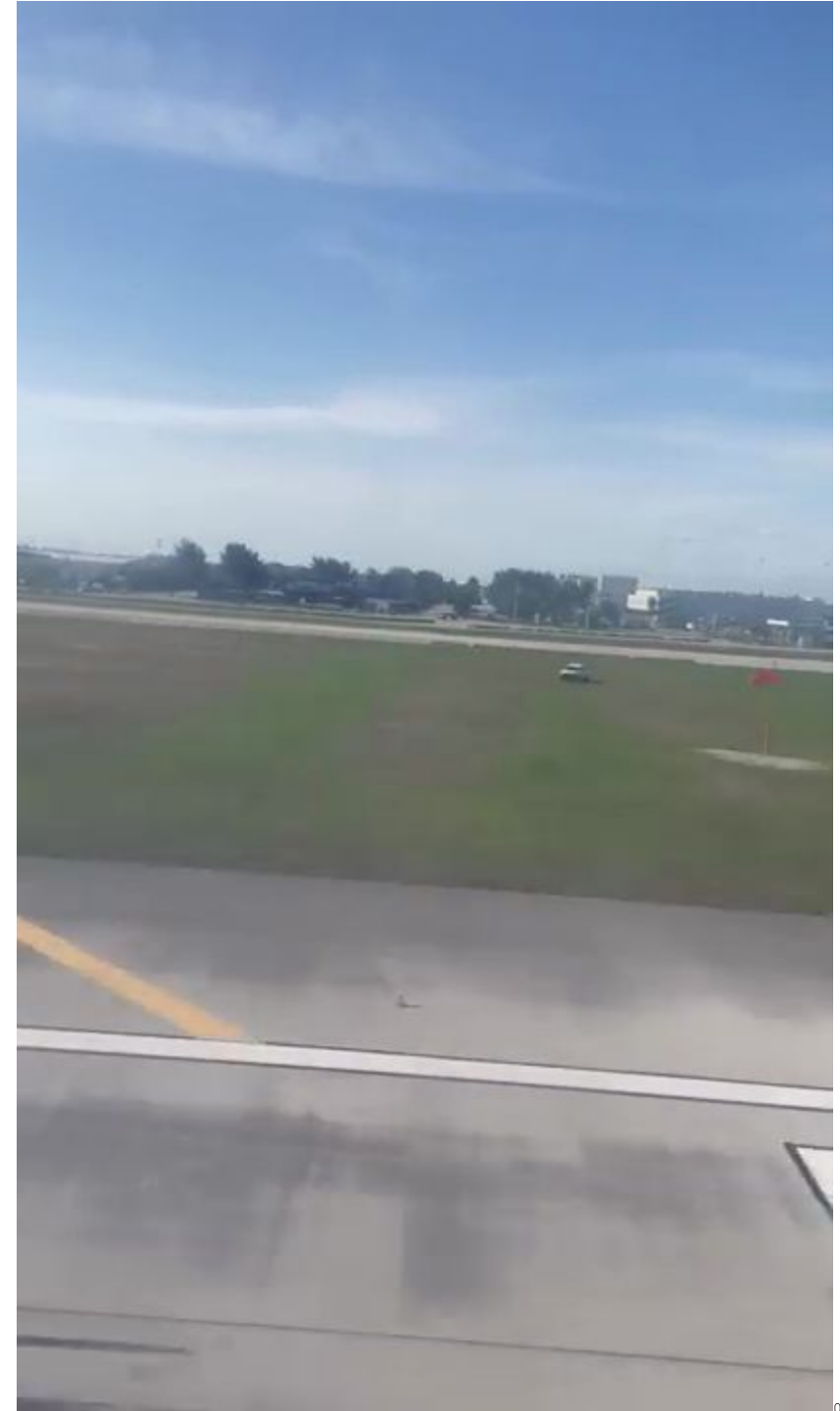

00093



00094



00095

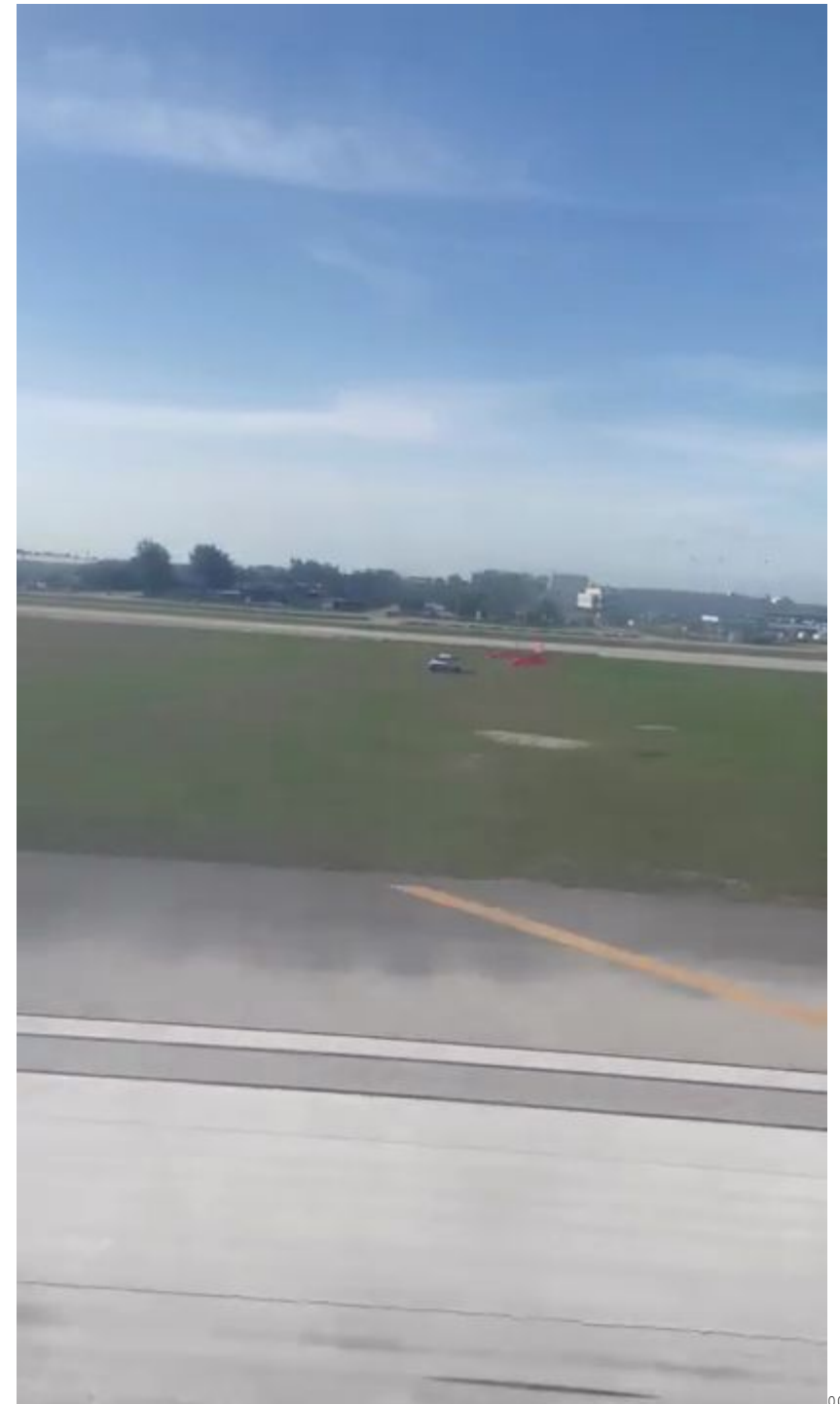

00096

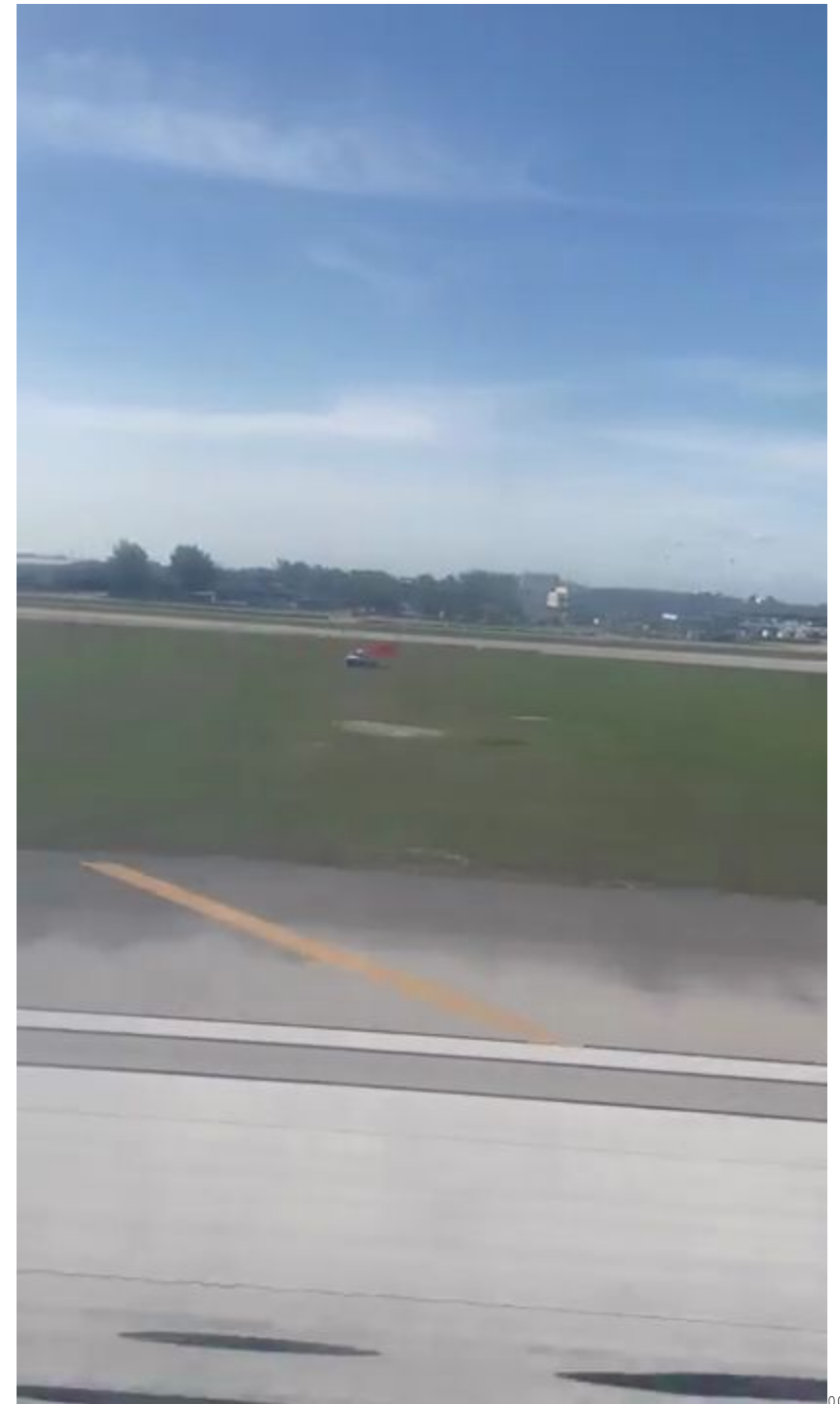



00100



00101

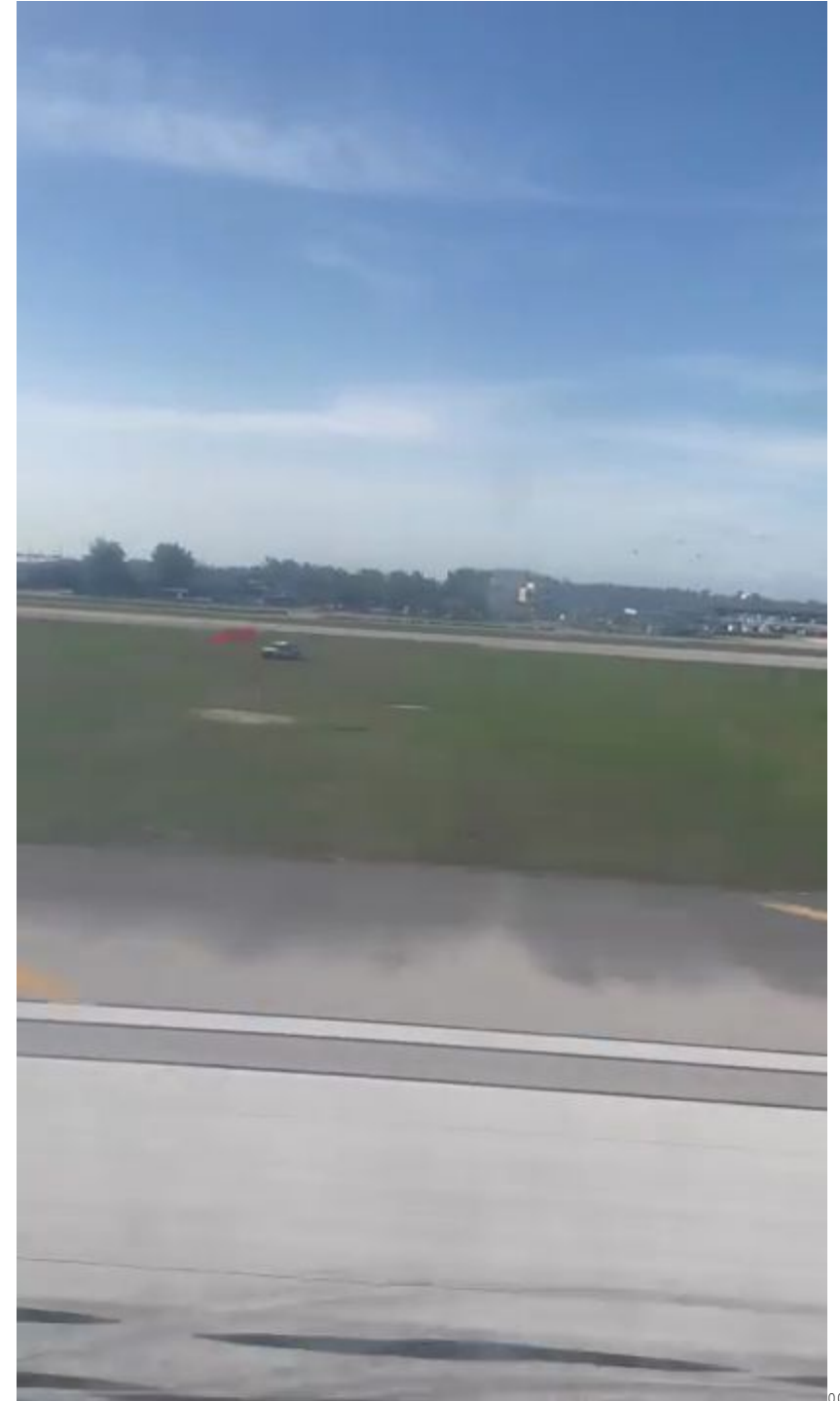

00102



00103



00104

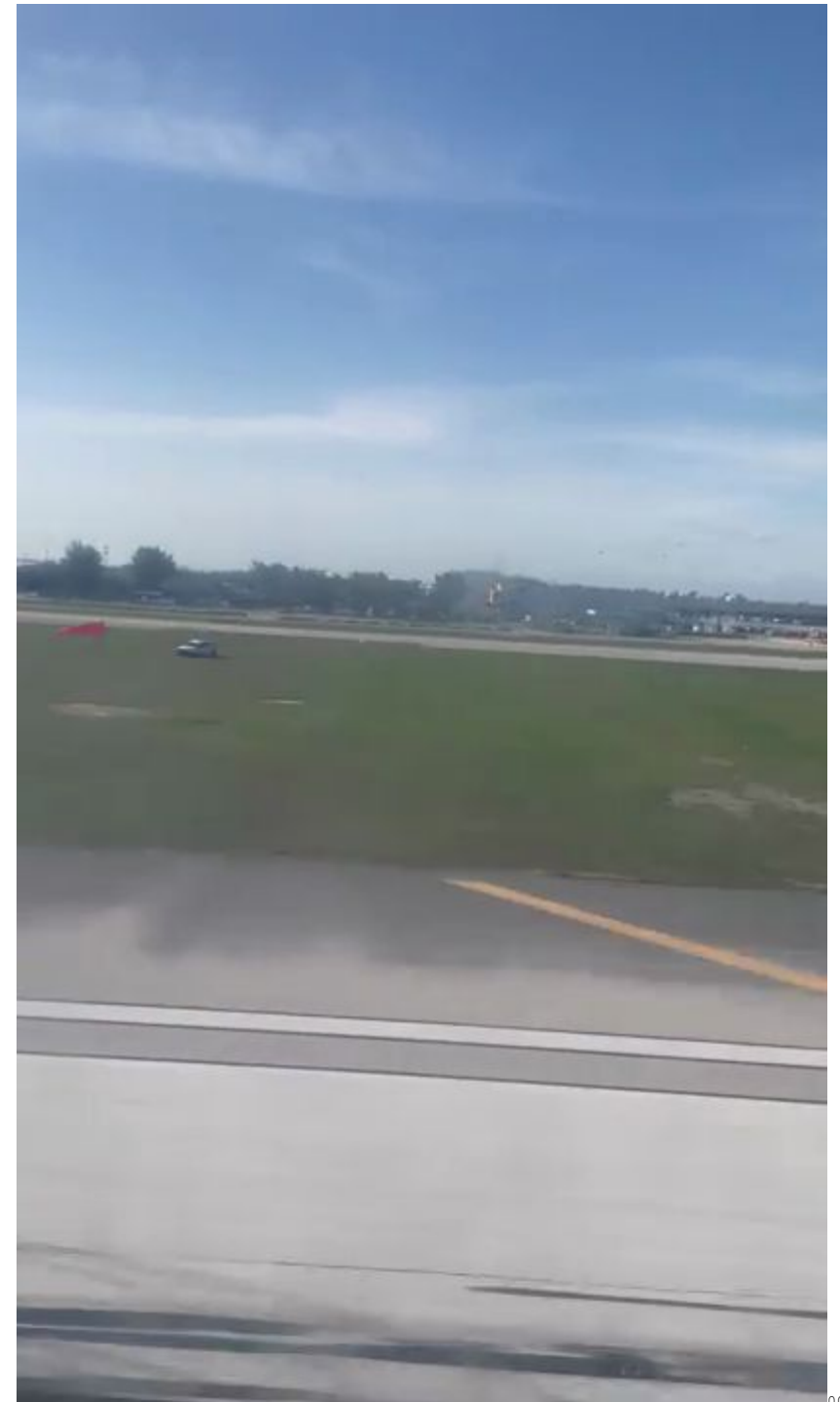

00105



00106



00107



00108



00109



00110



00111



00112



00113

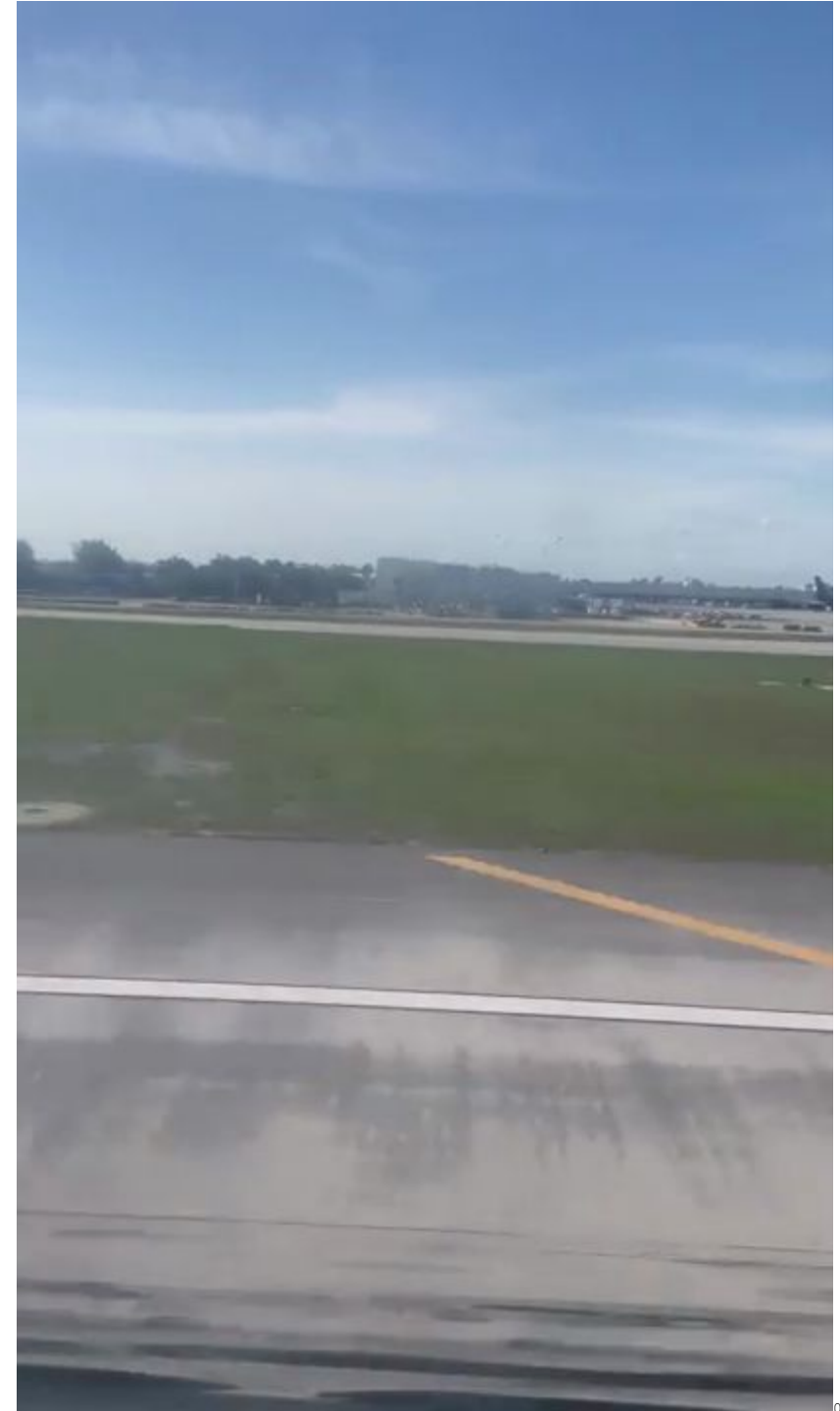

00114



00115



00116



00117



00118



00119

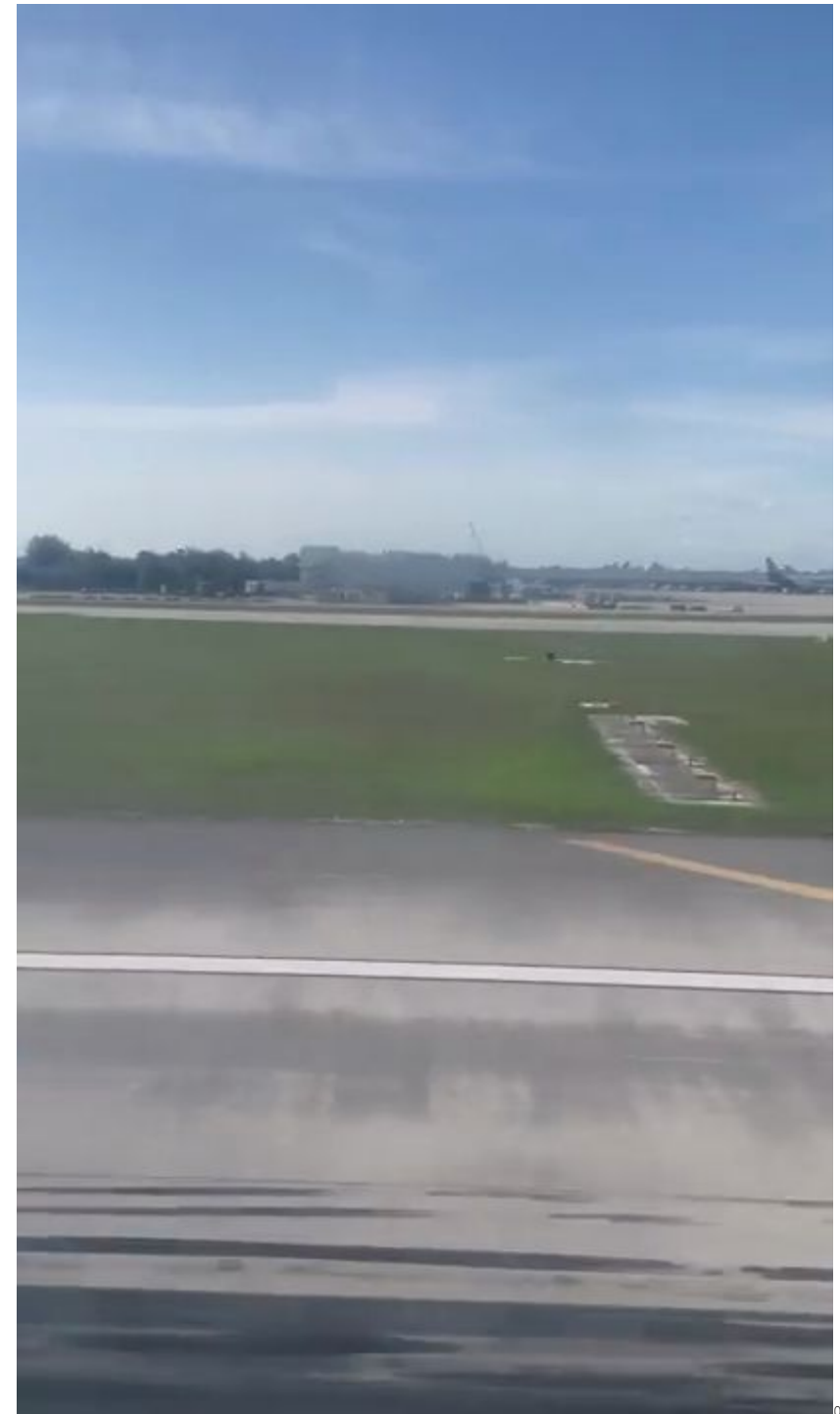

00120

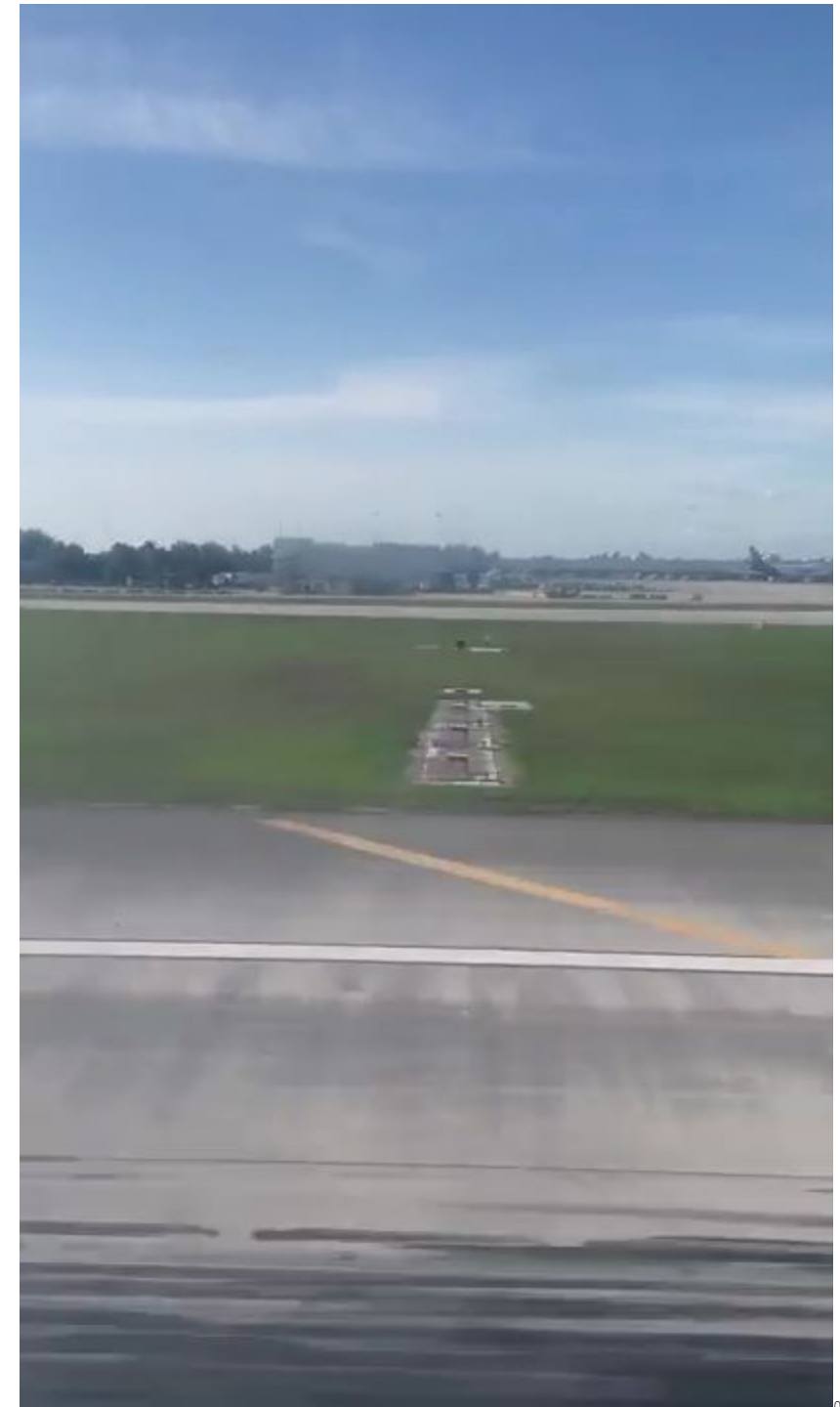
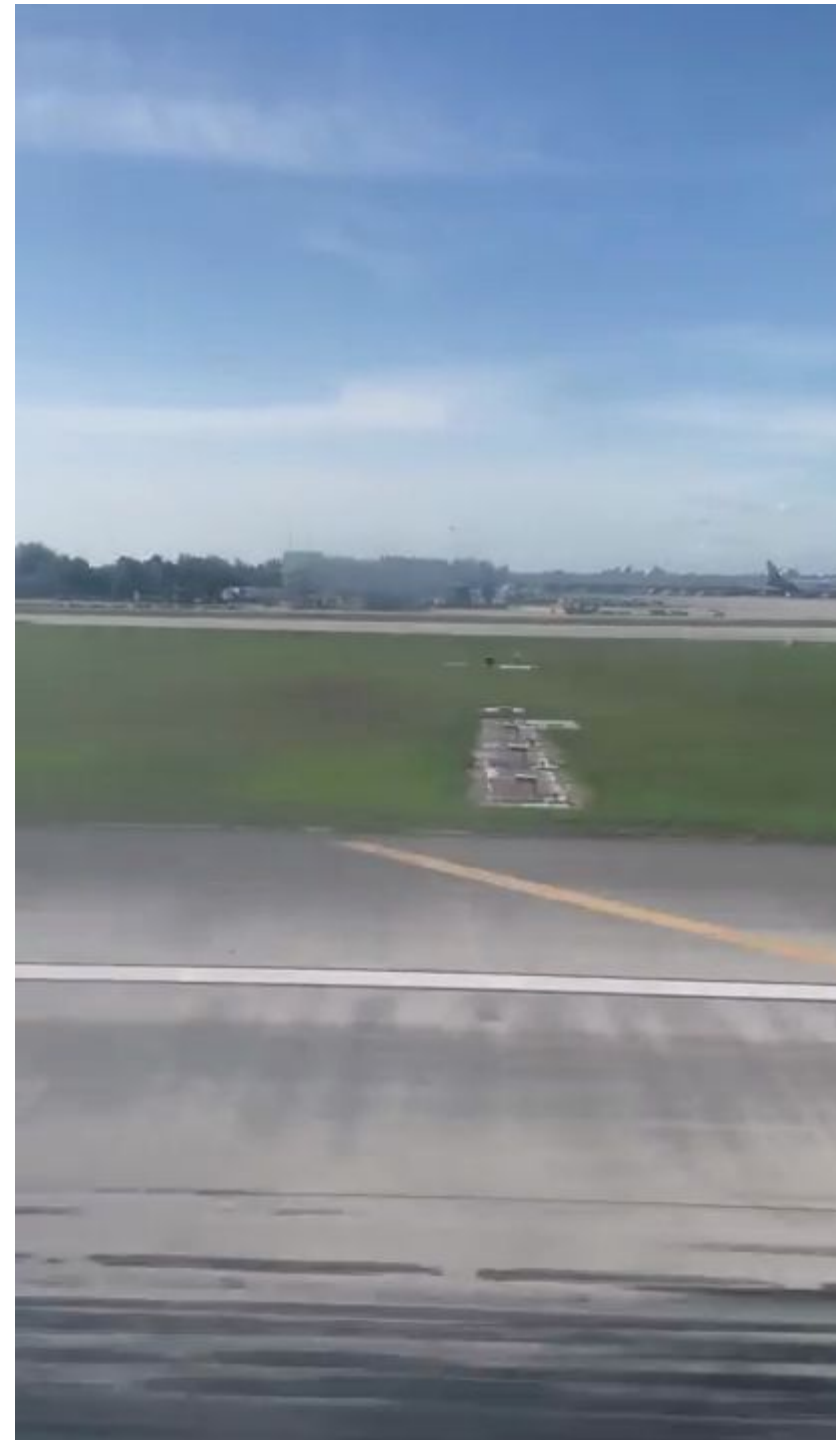



00124



00125

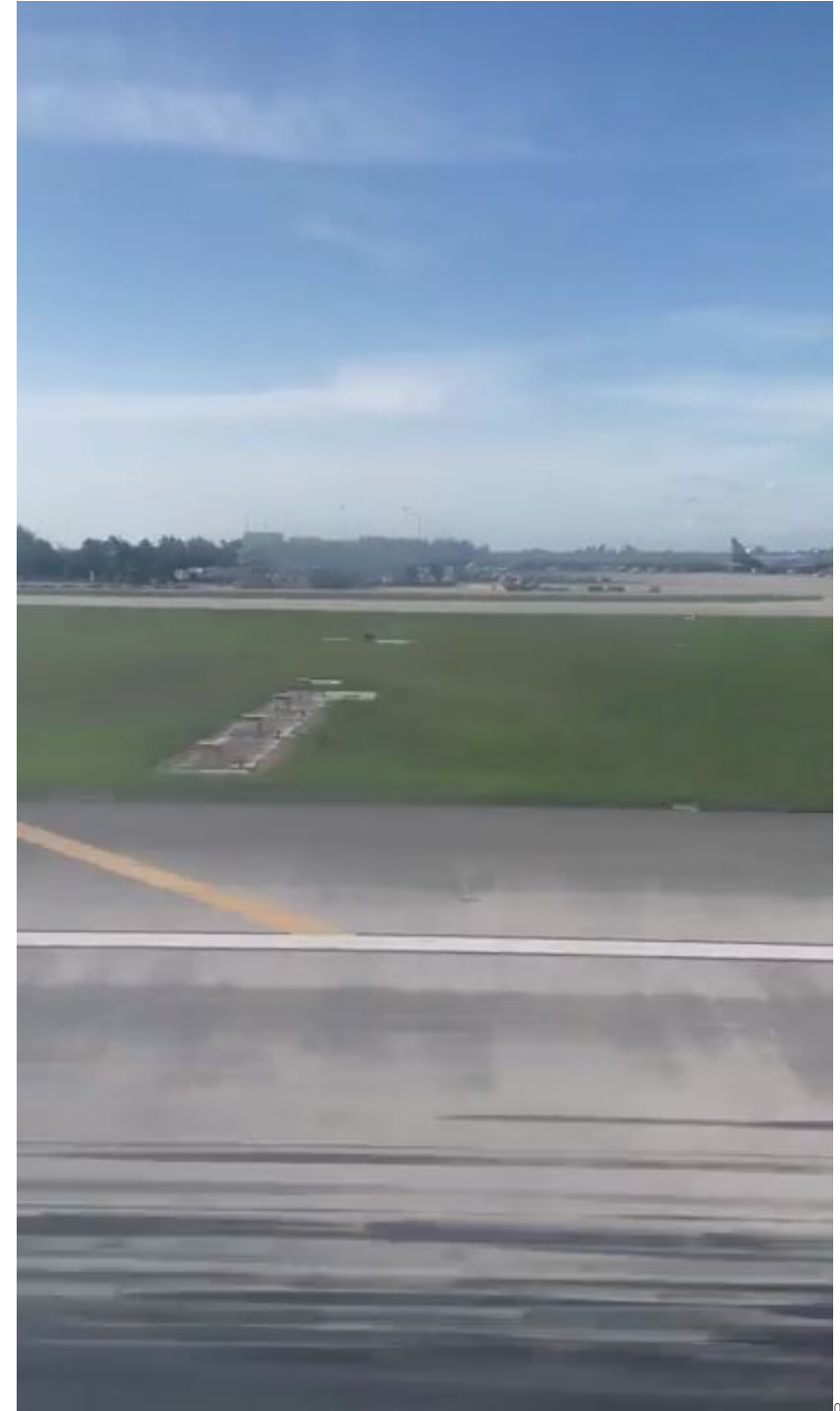

00126



00127



00128

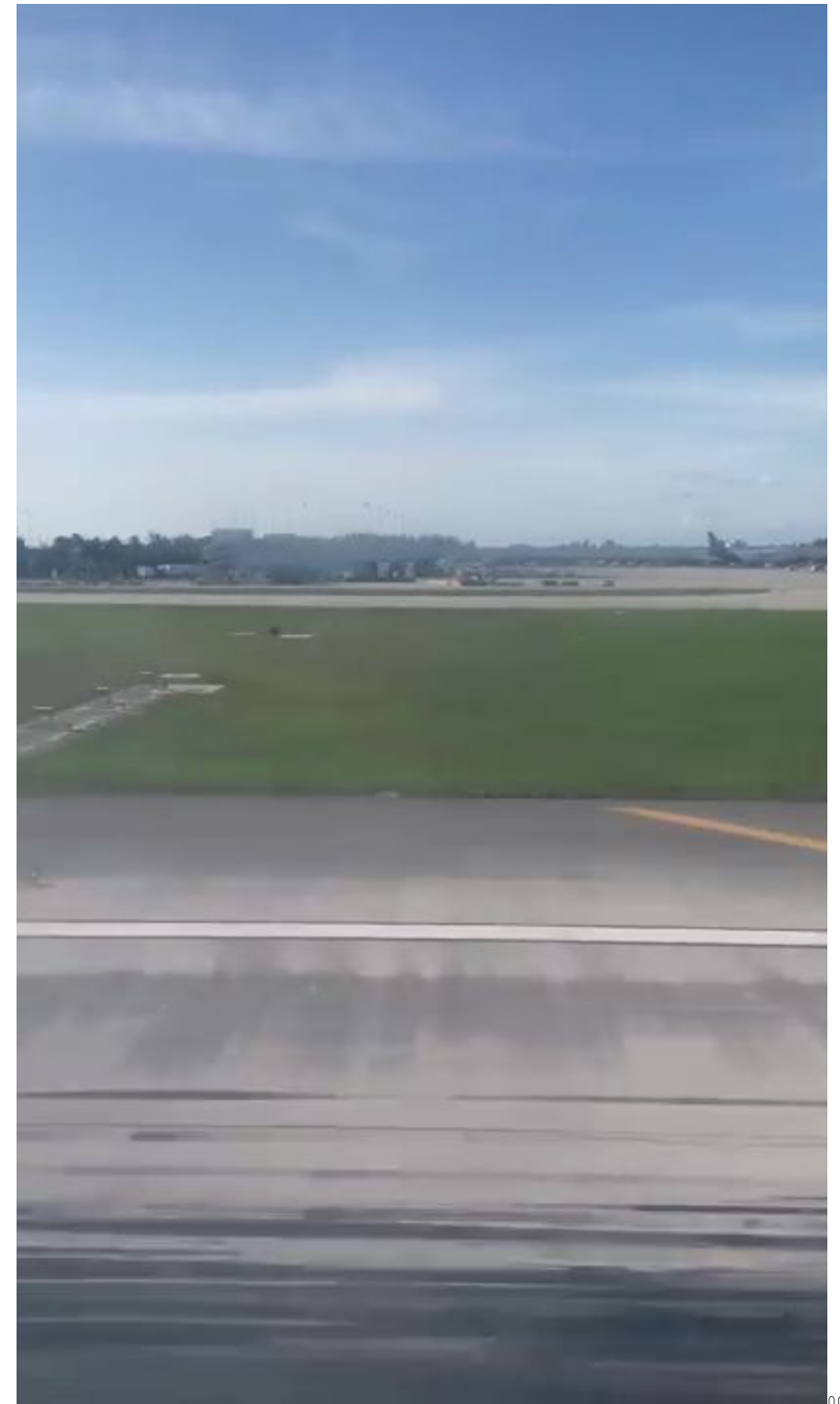

00129

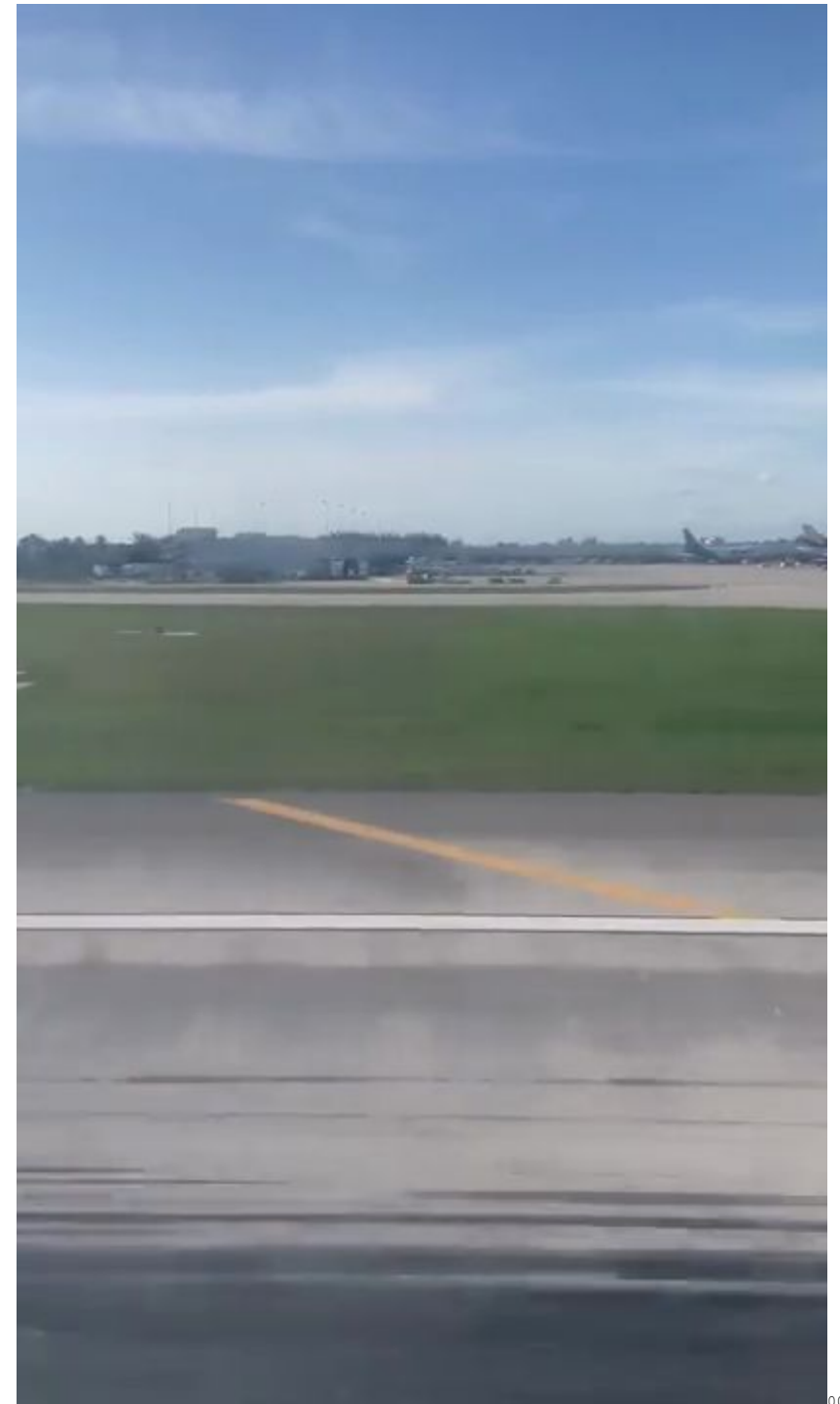

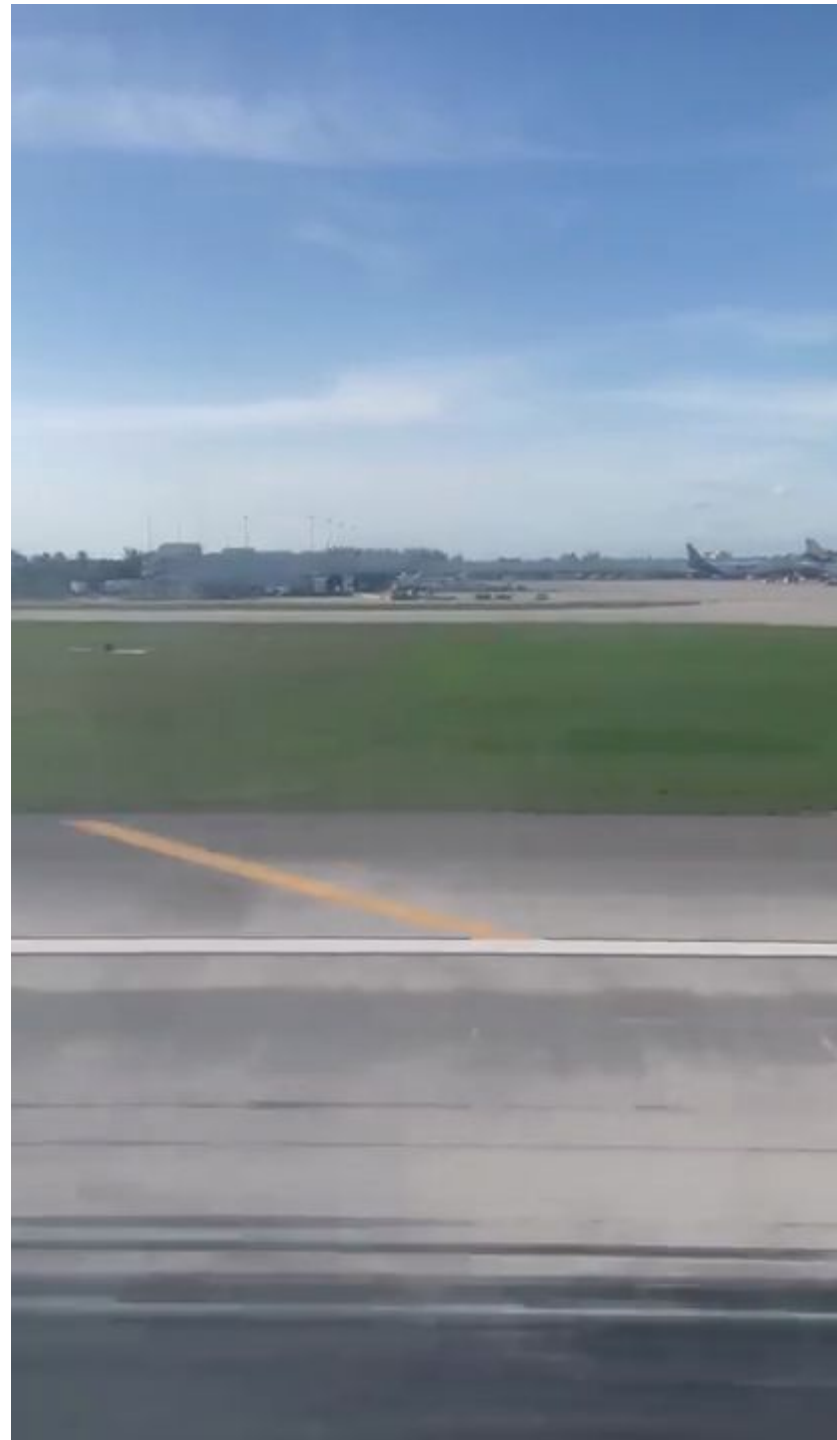

00133



00134

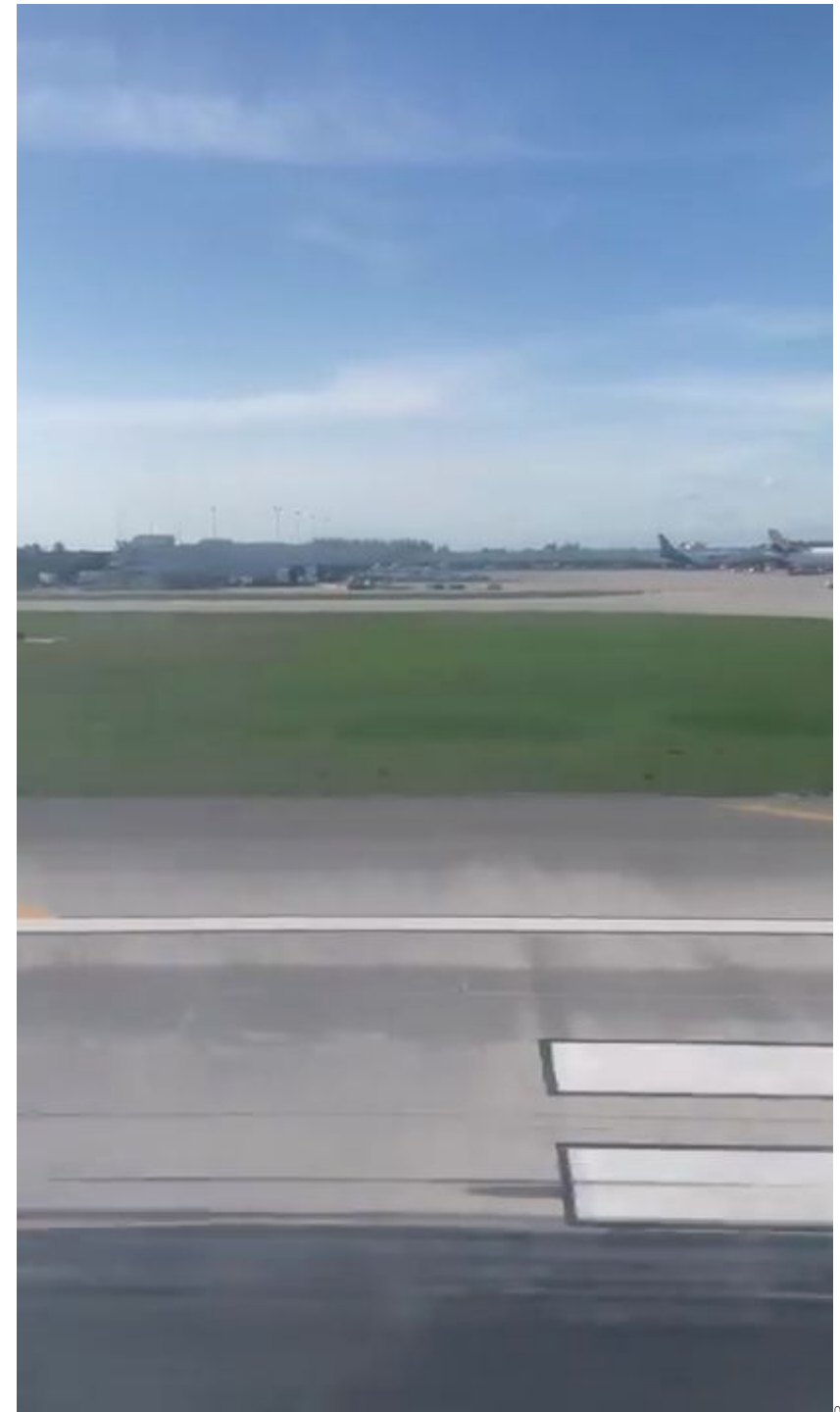

00135

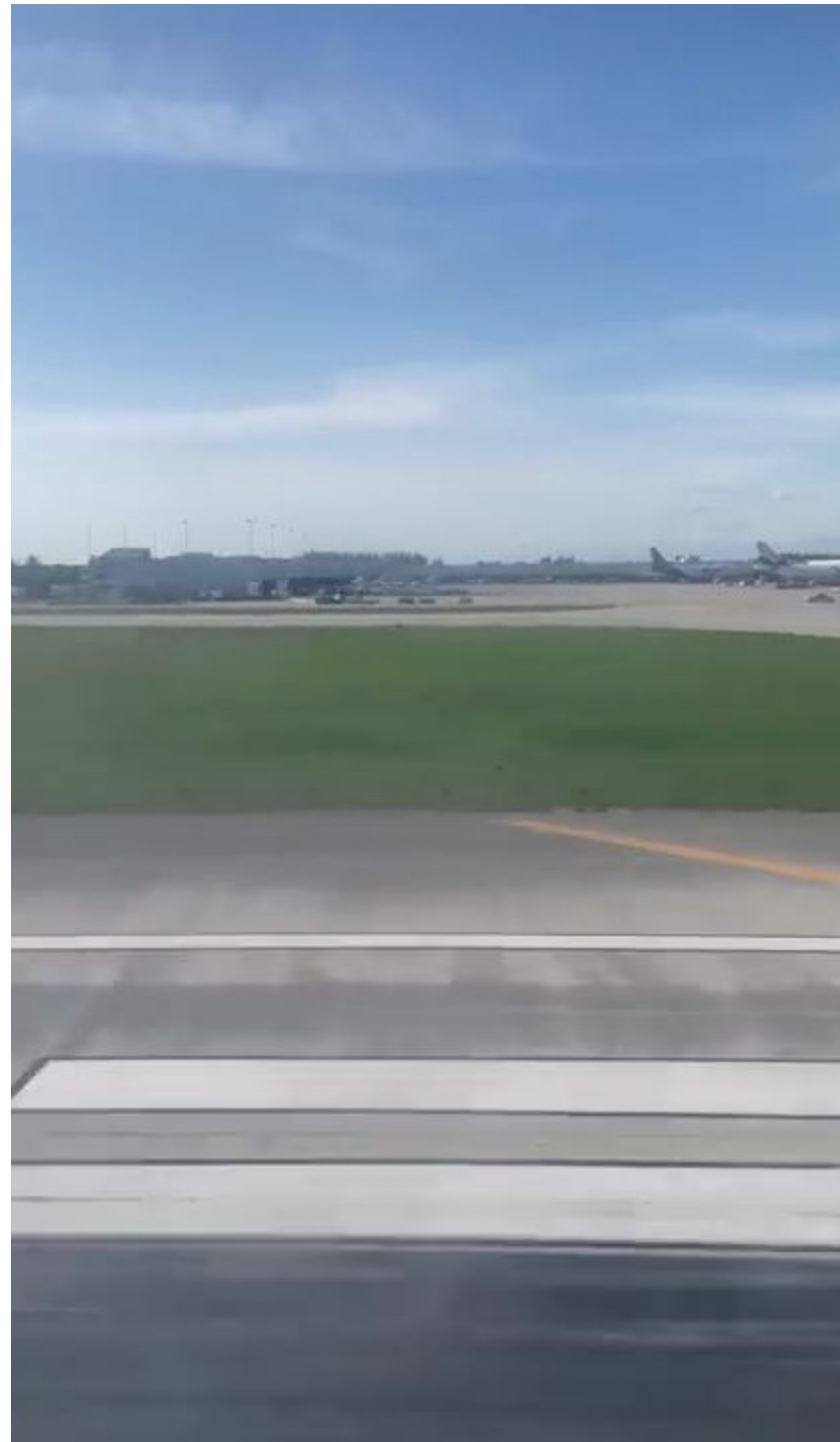

00136

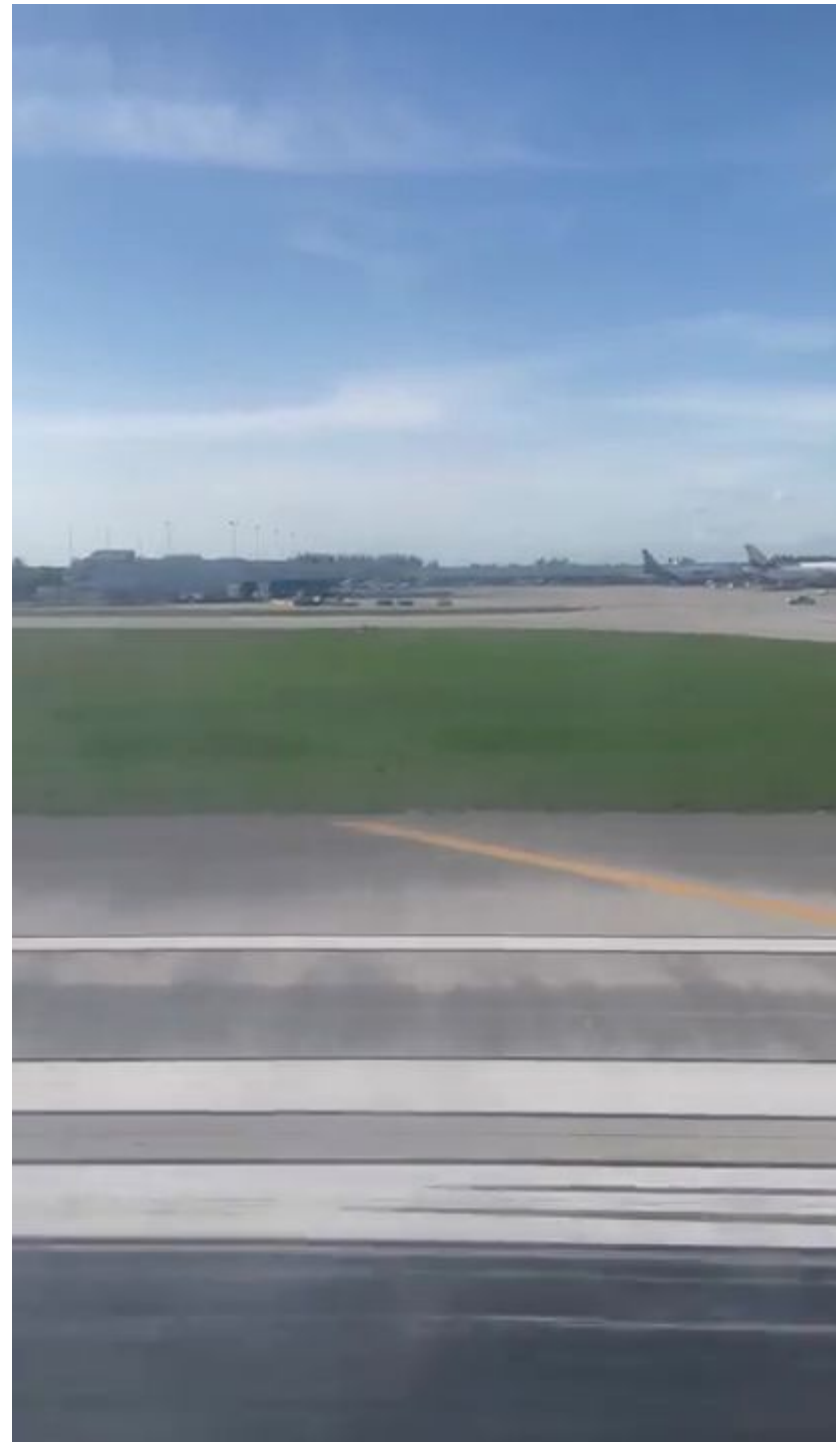

00137

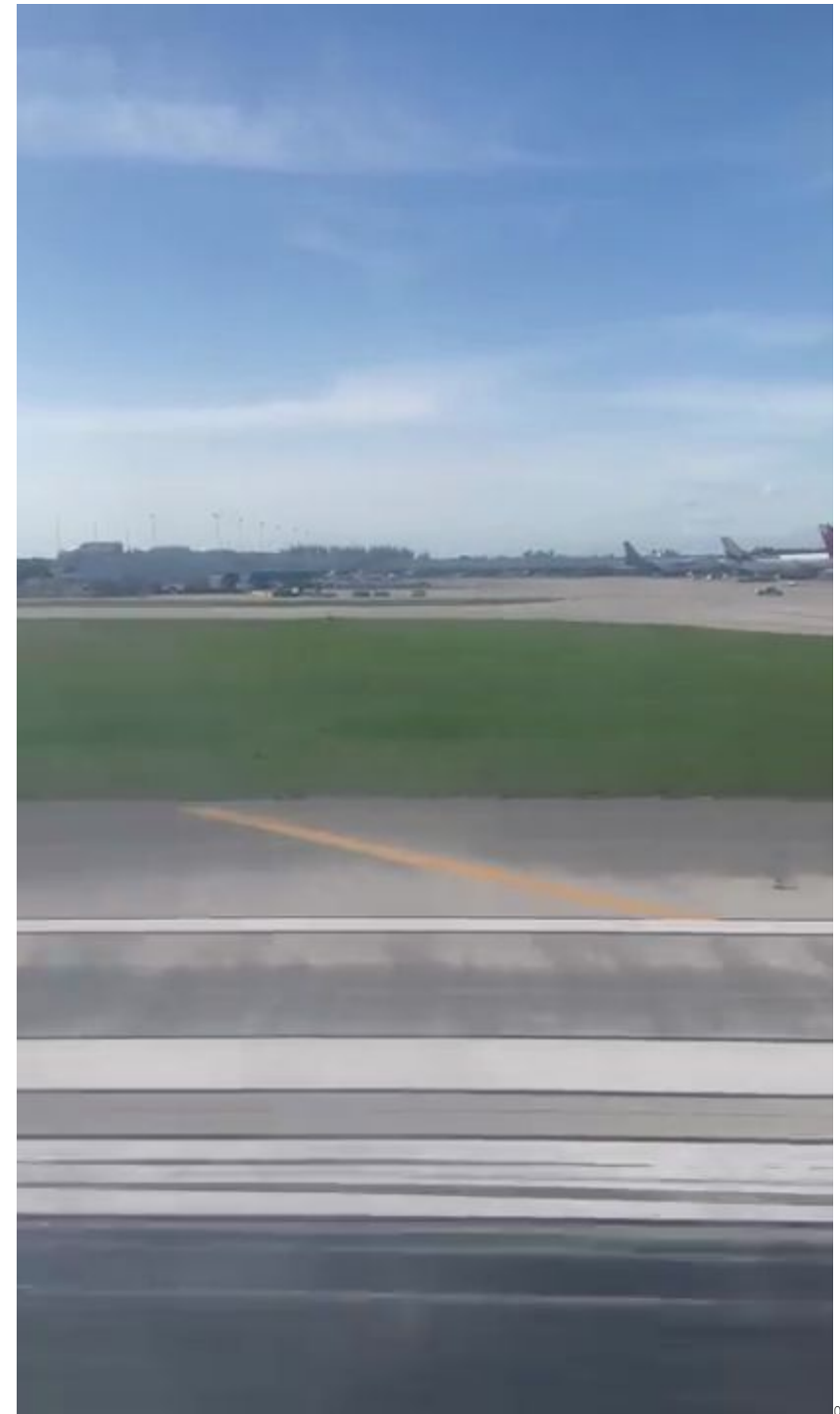

00138



00139

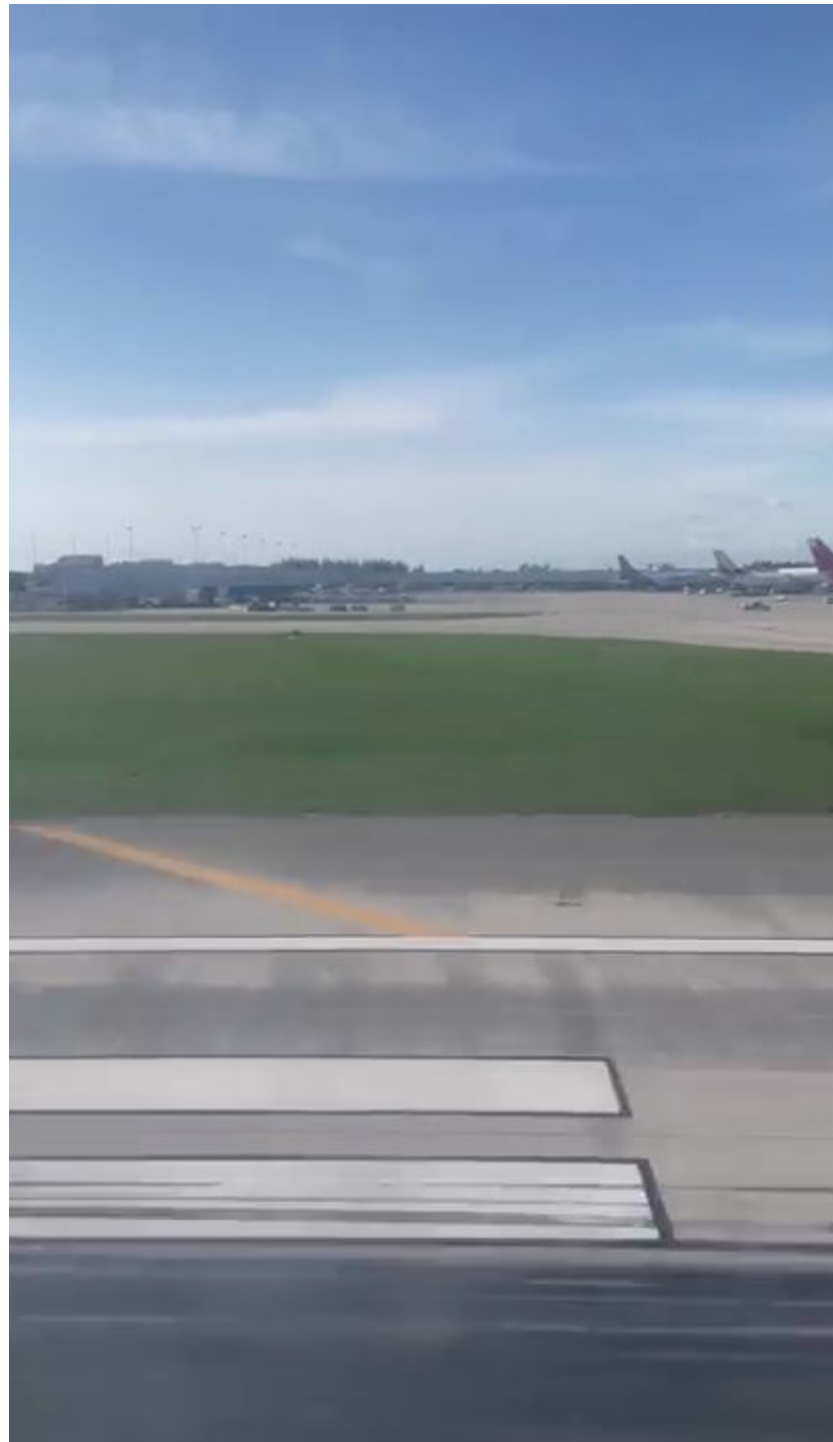

00140

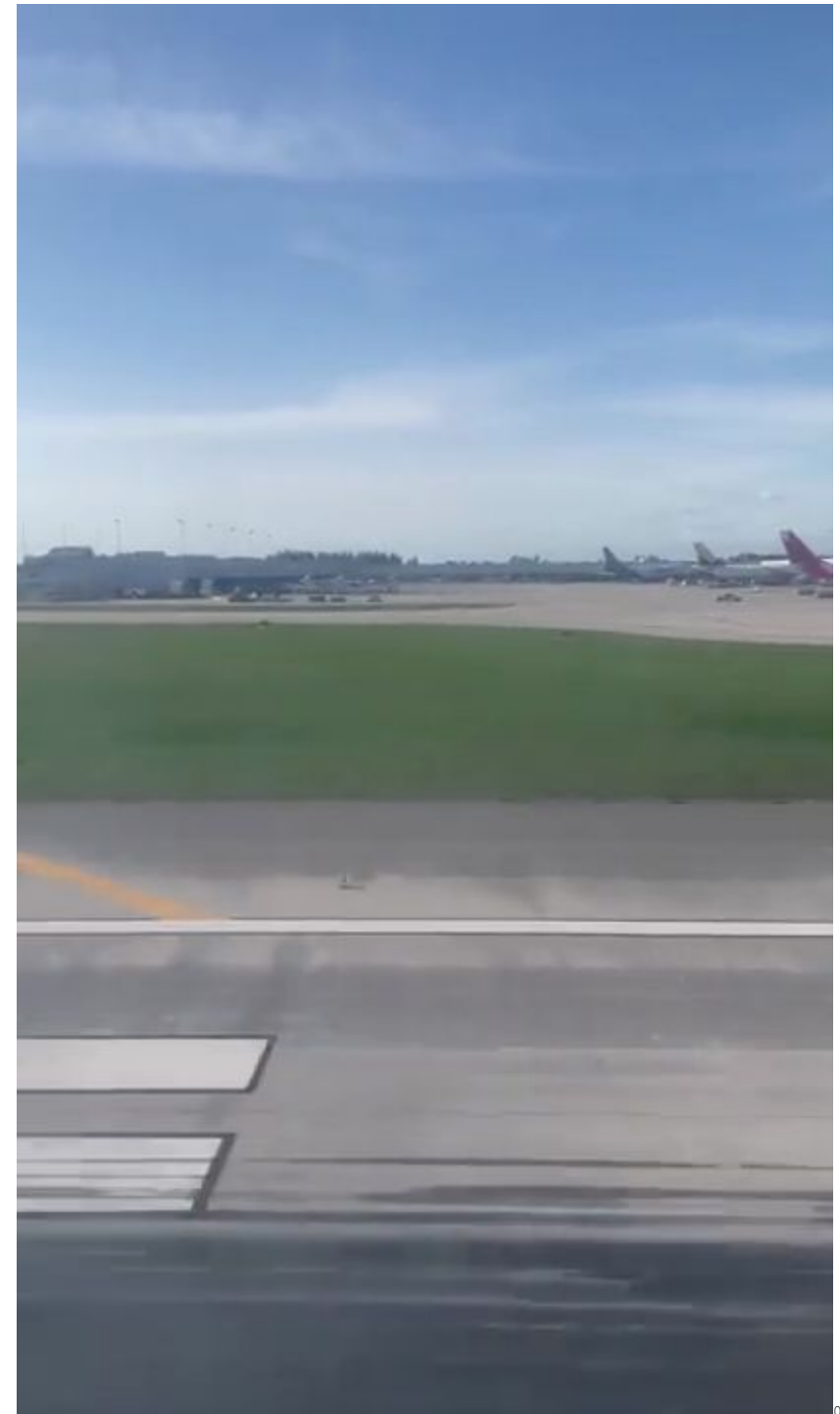

00141

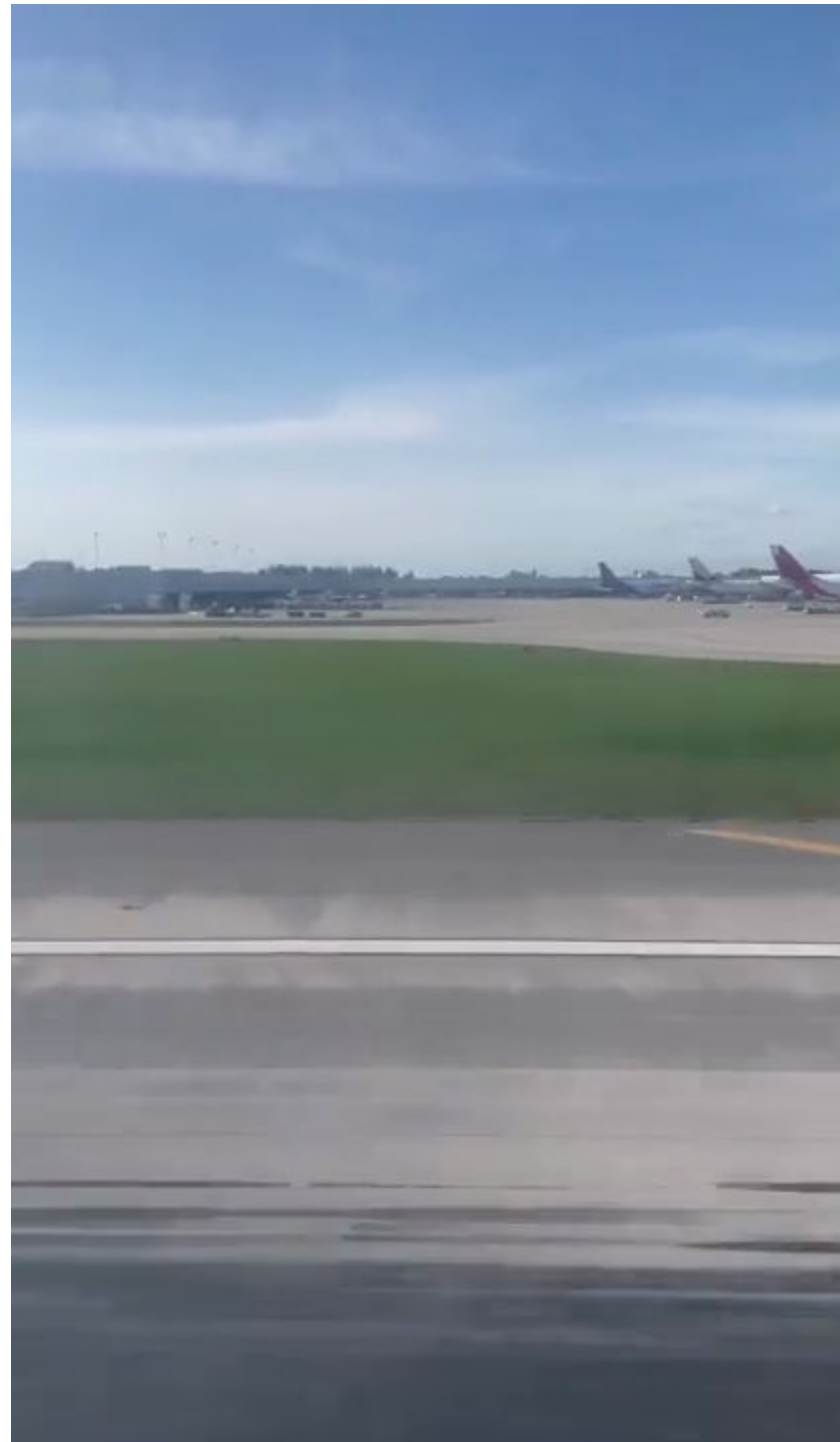

00142



00143

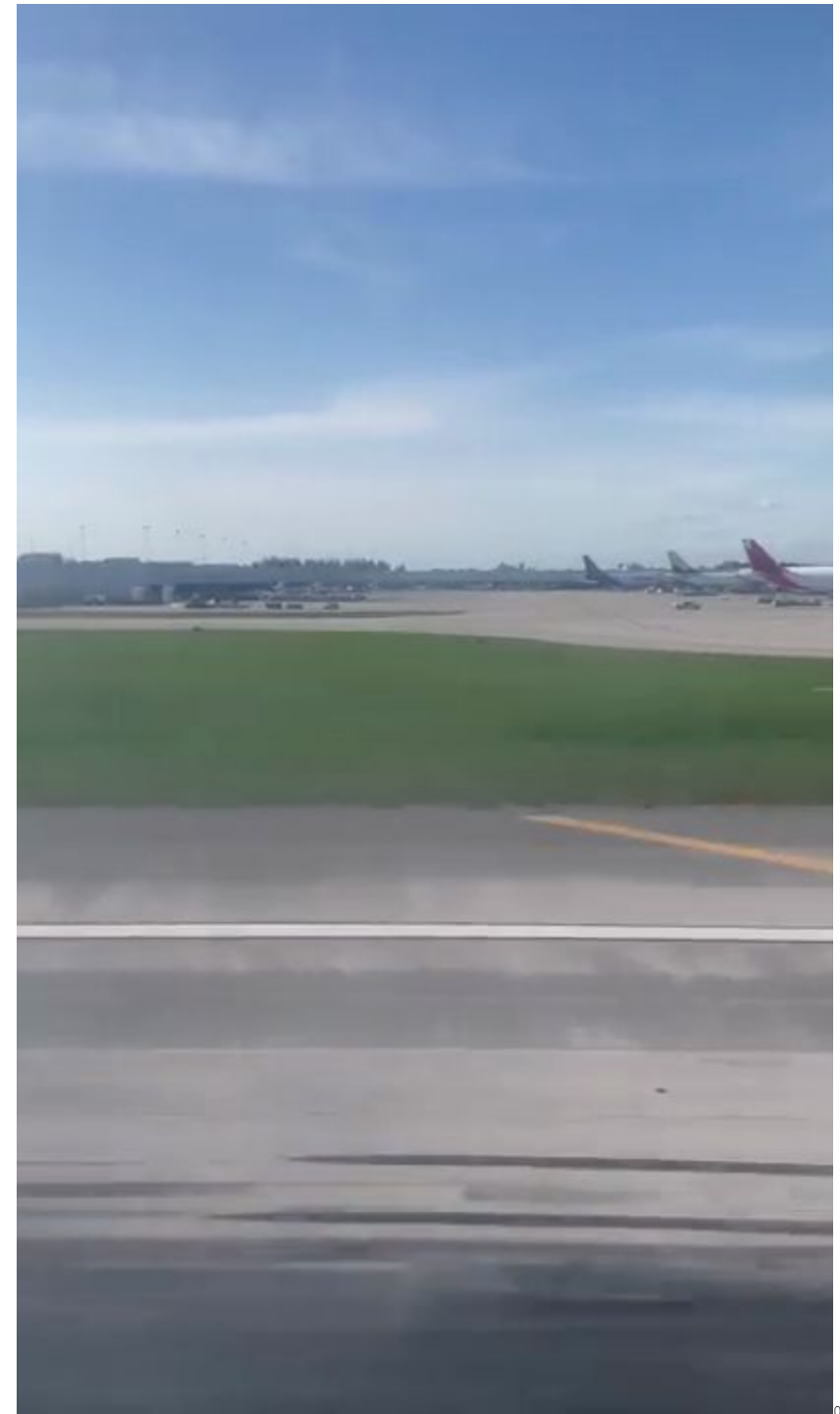

00144



00145

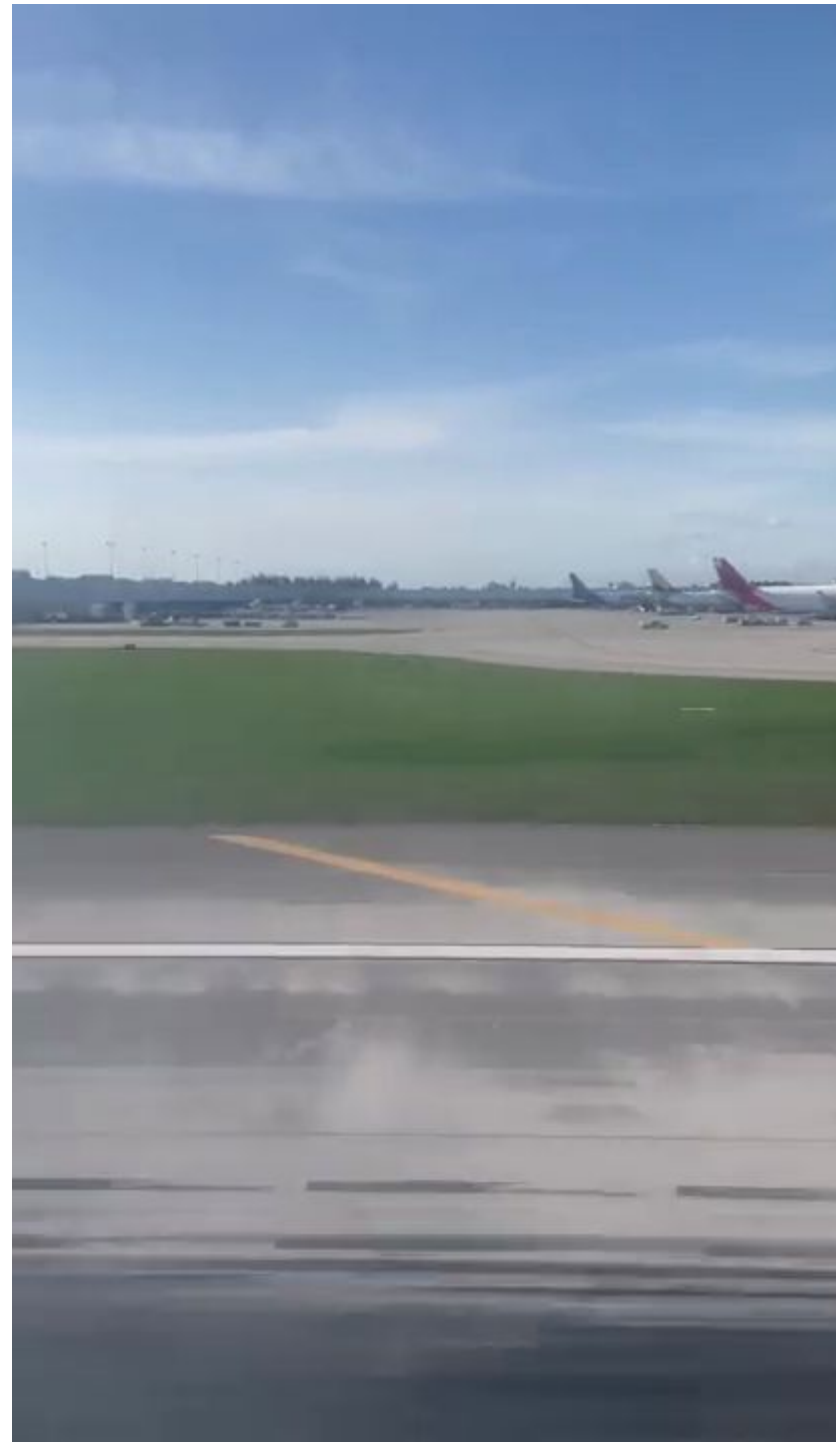

00146



00147



00148



00149



00150



00151



00152



00153

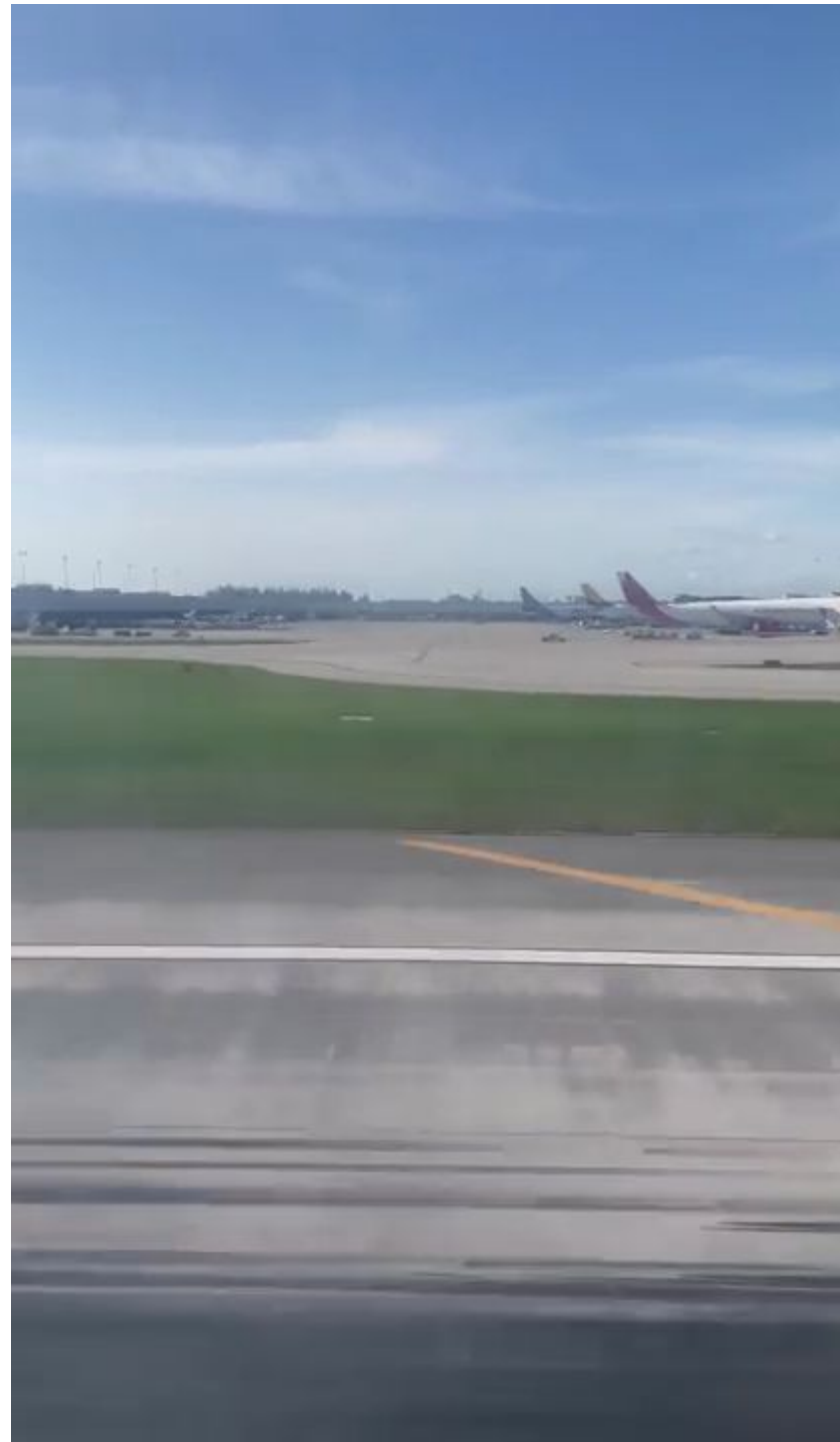

00154



00155



00156



00157



00158

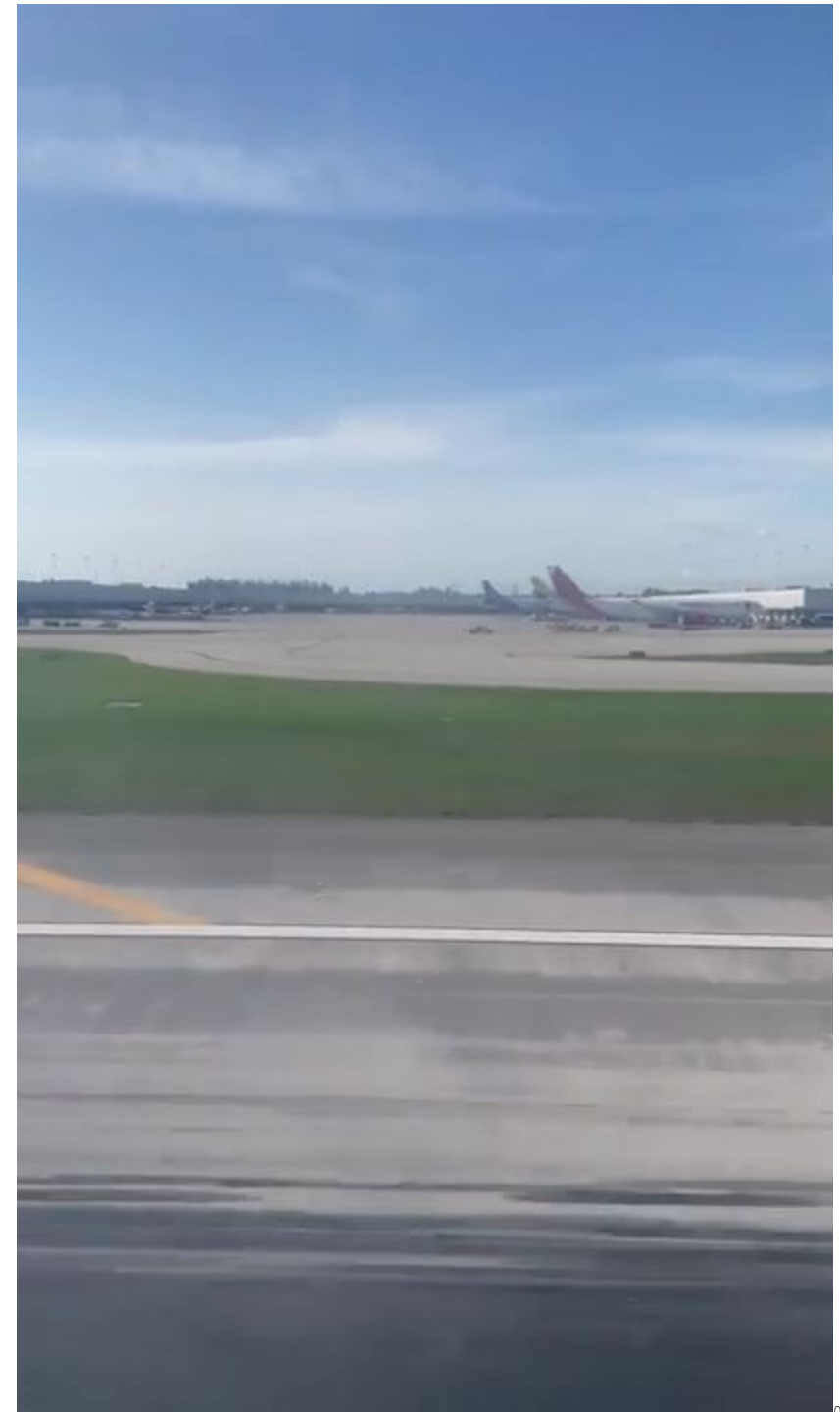

00159



00160



00161

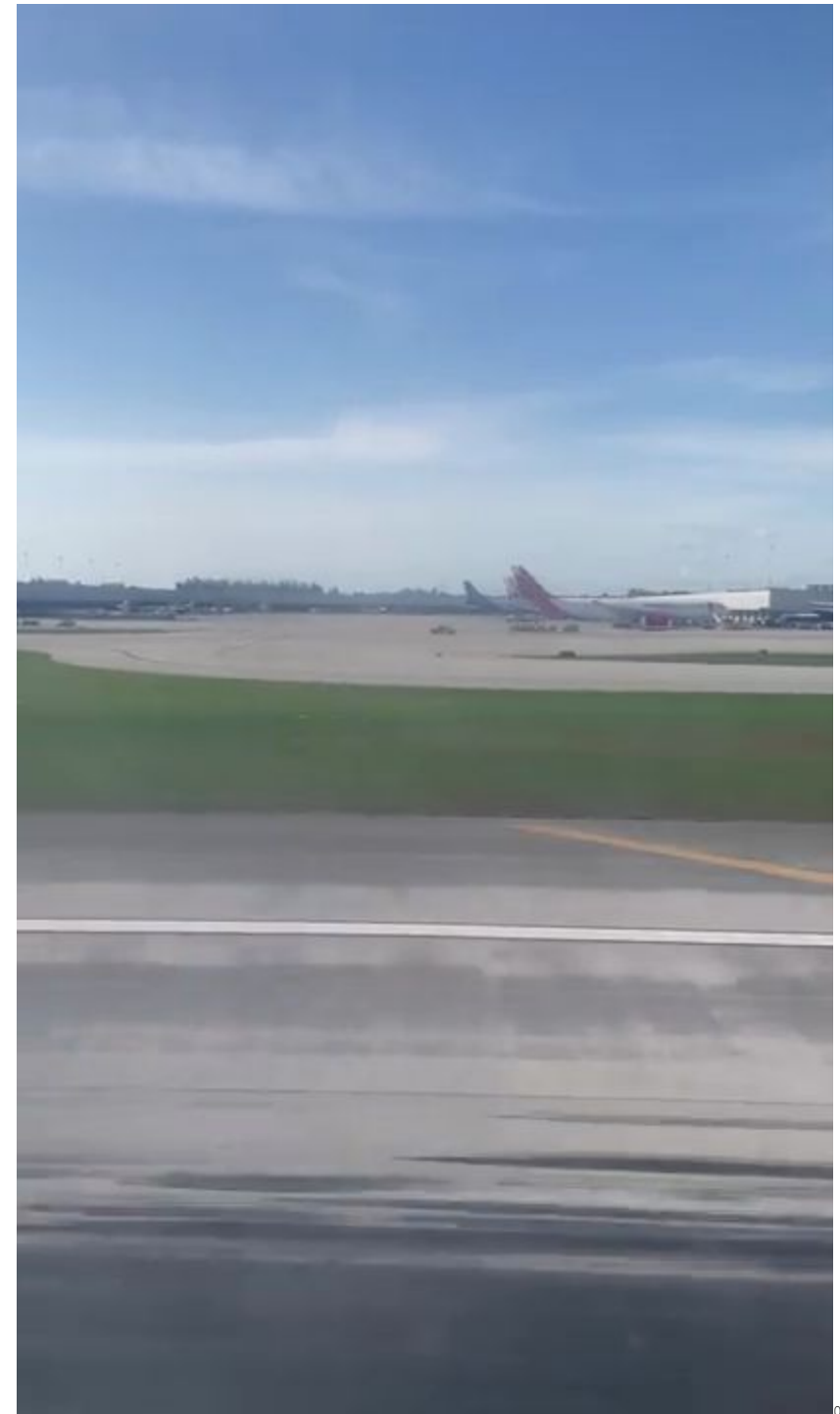

00162



00163

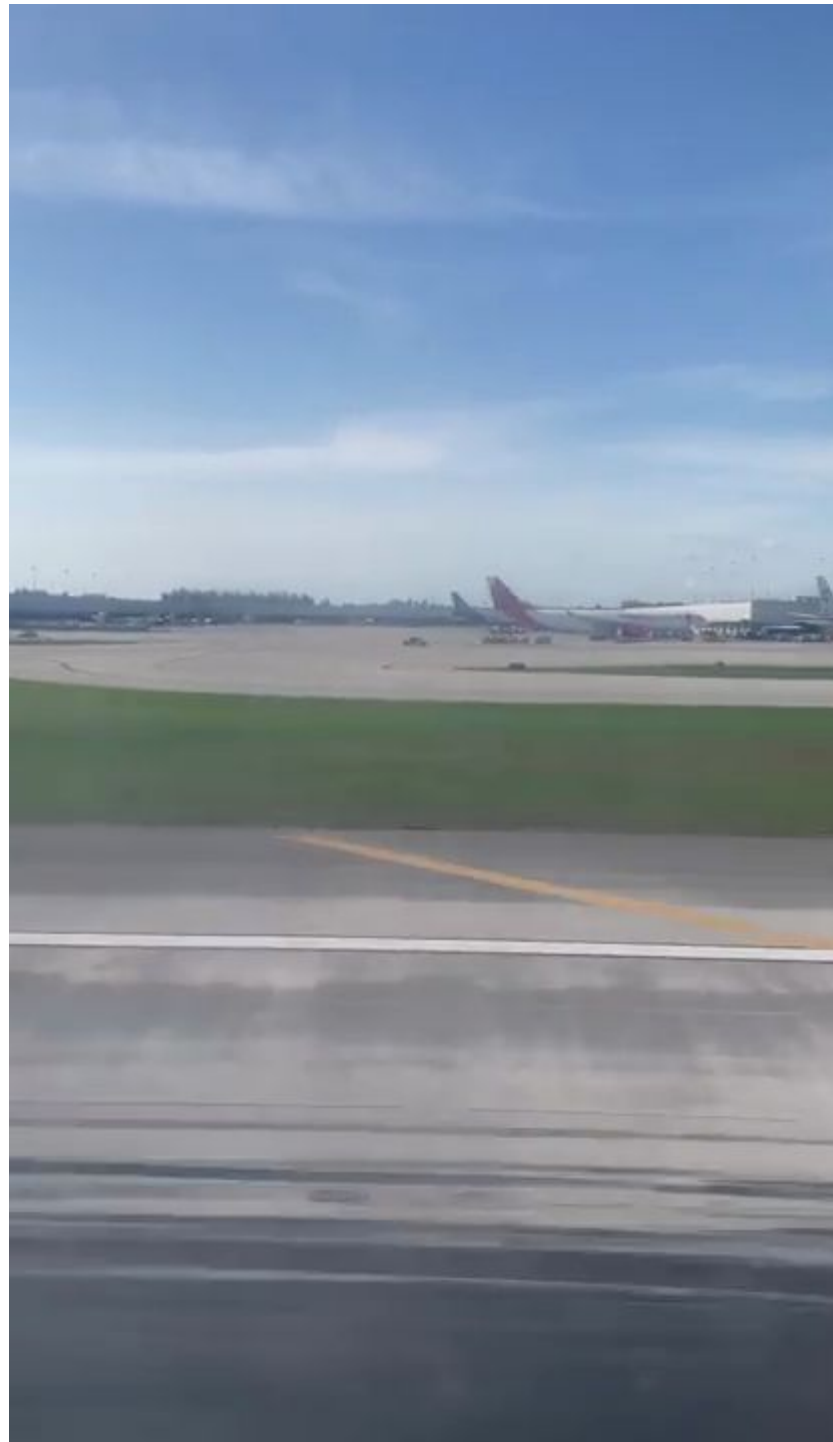

00164

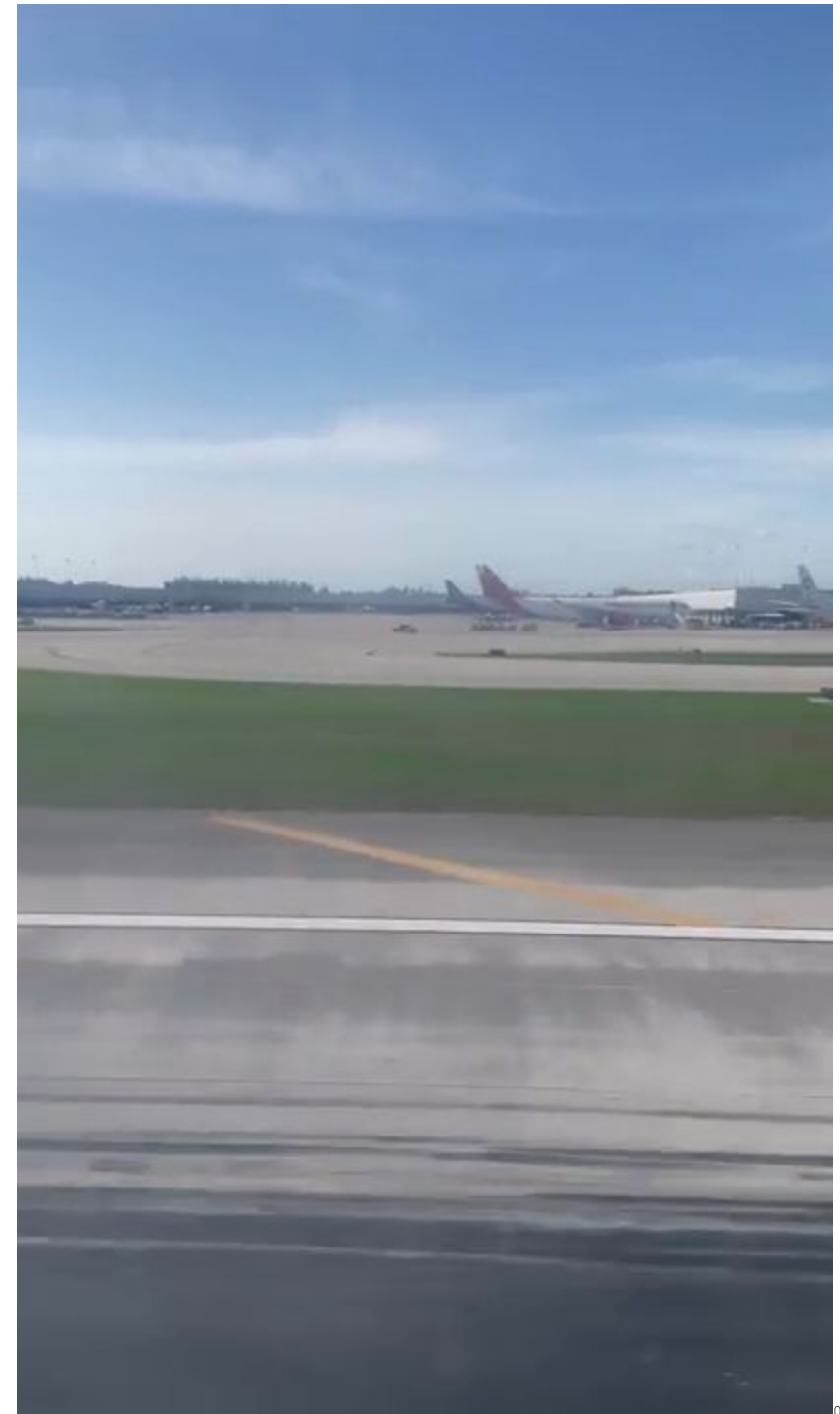

00165



00166



00167

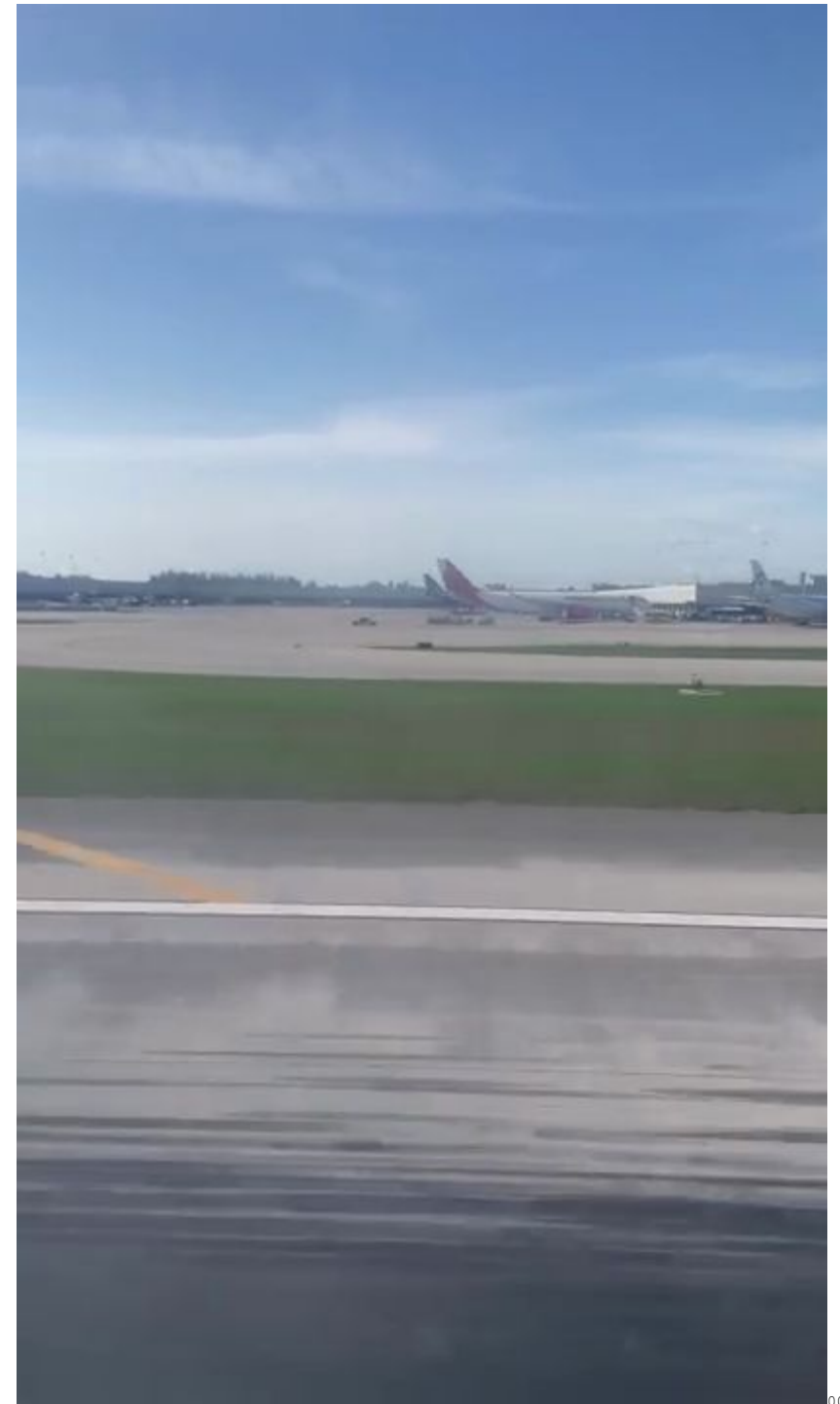

00168



00169



00170

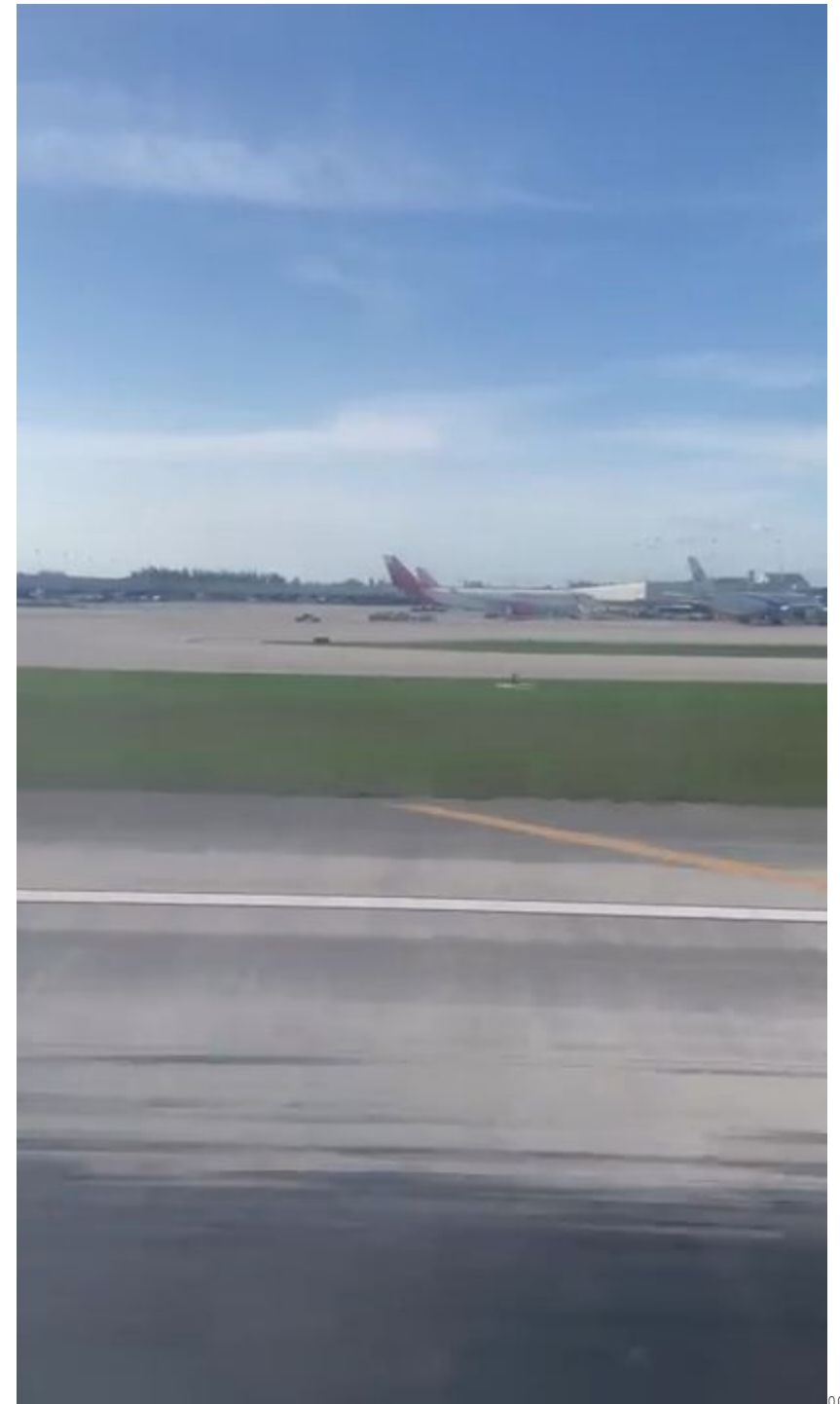

00171



00172



00173

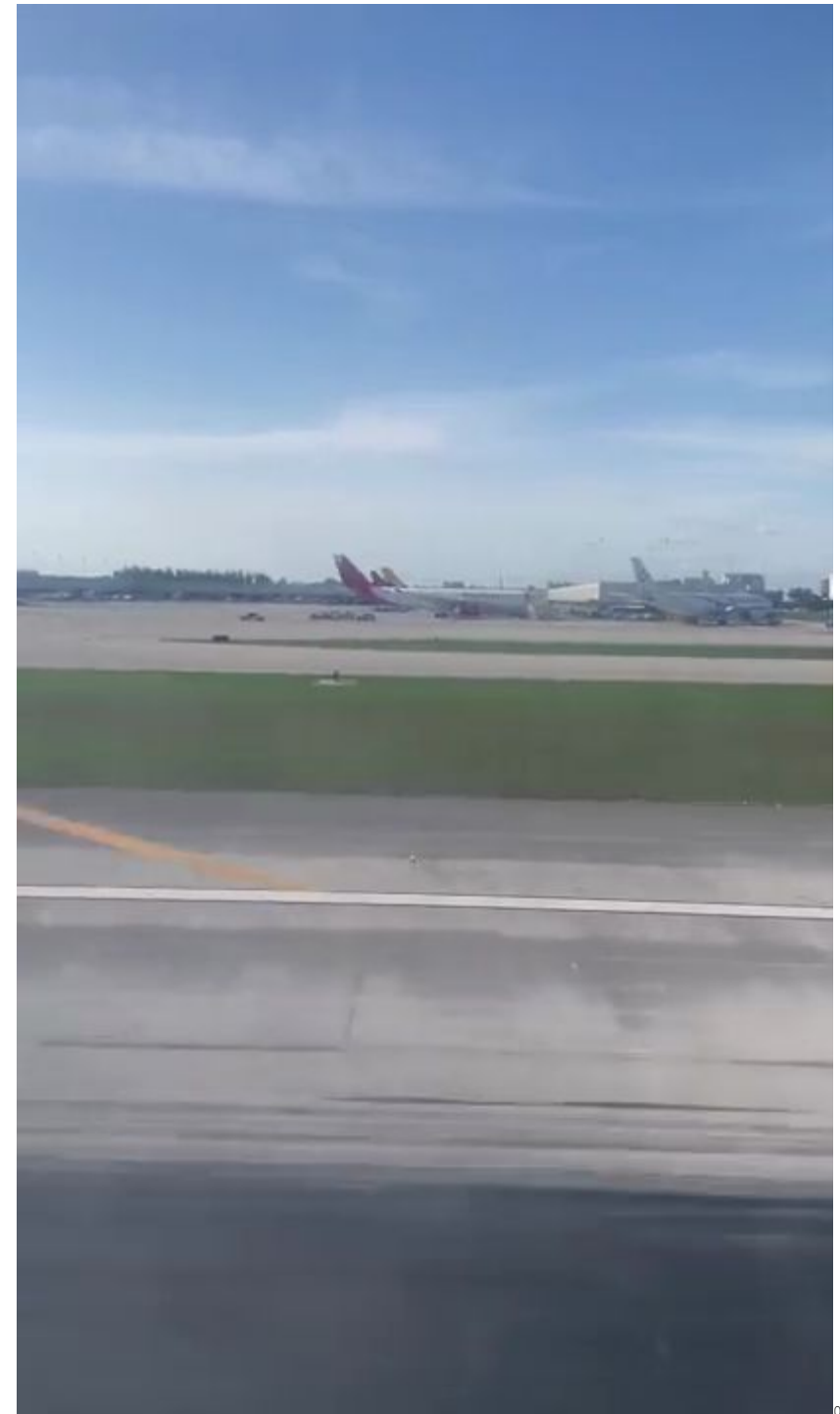

00174



00175

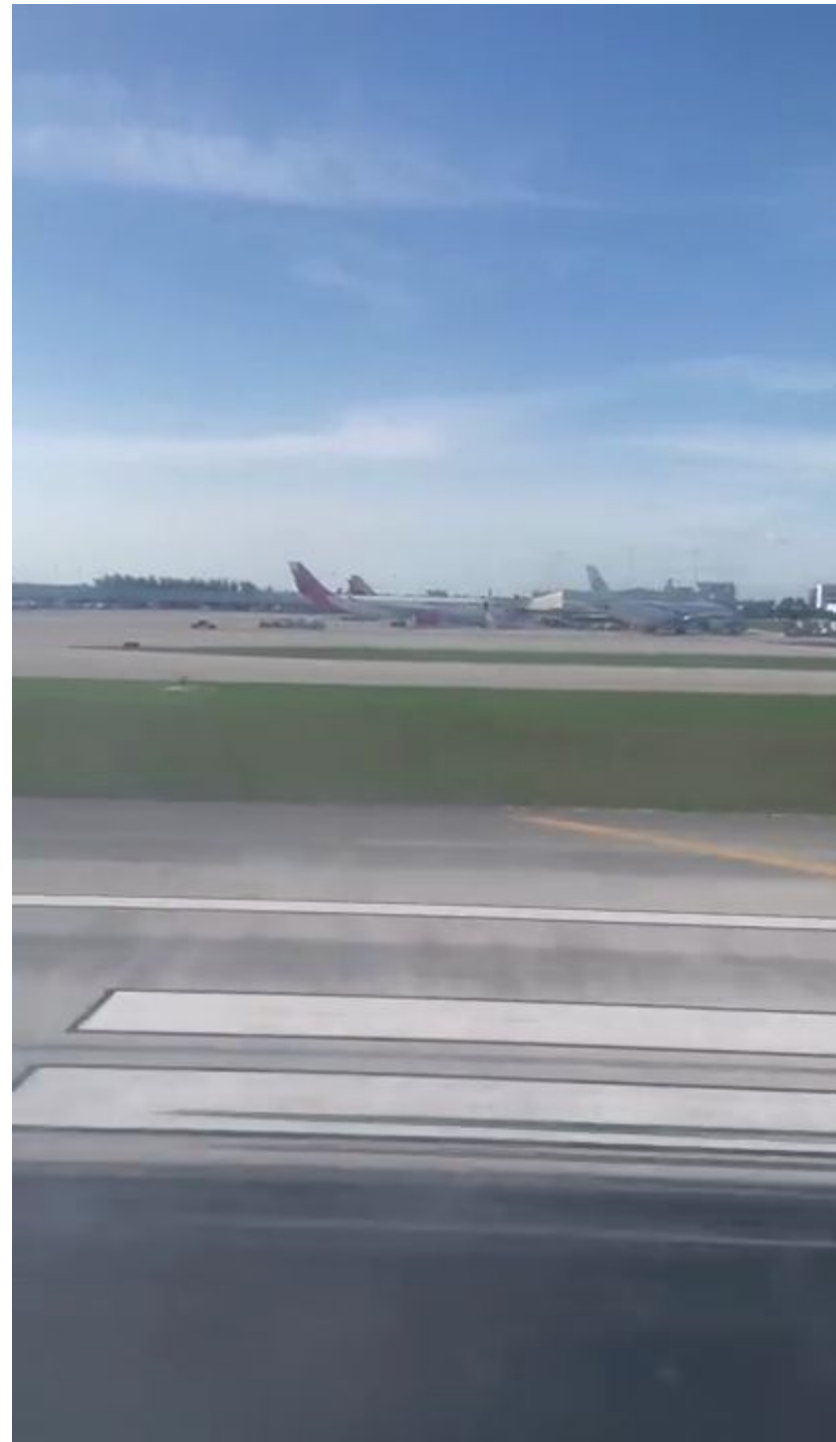

00176

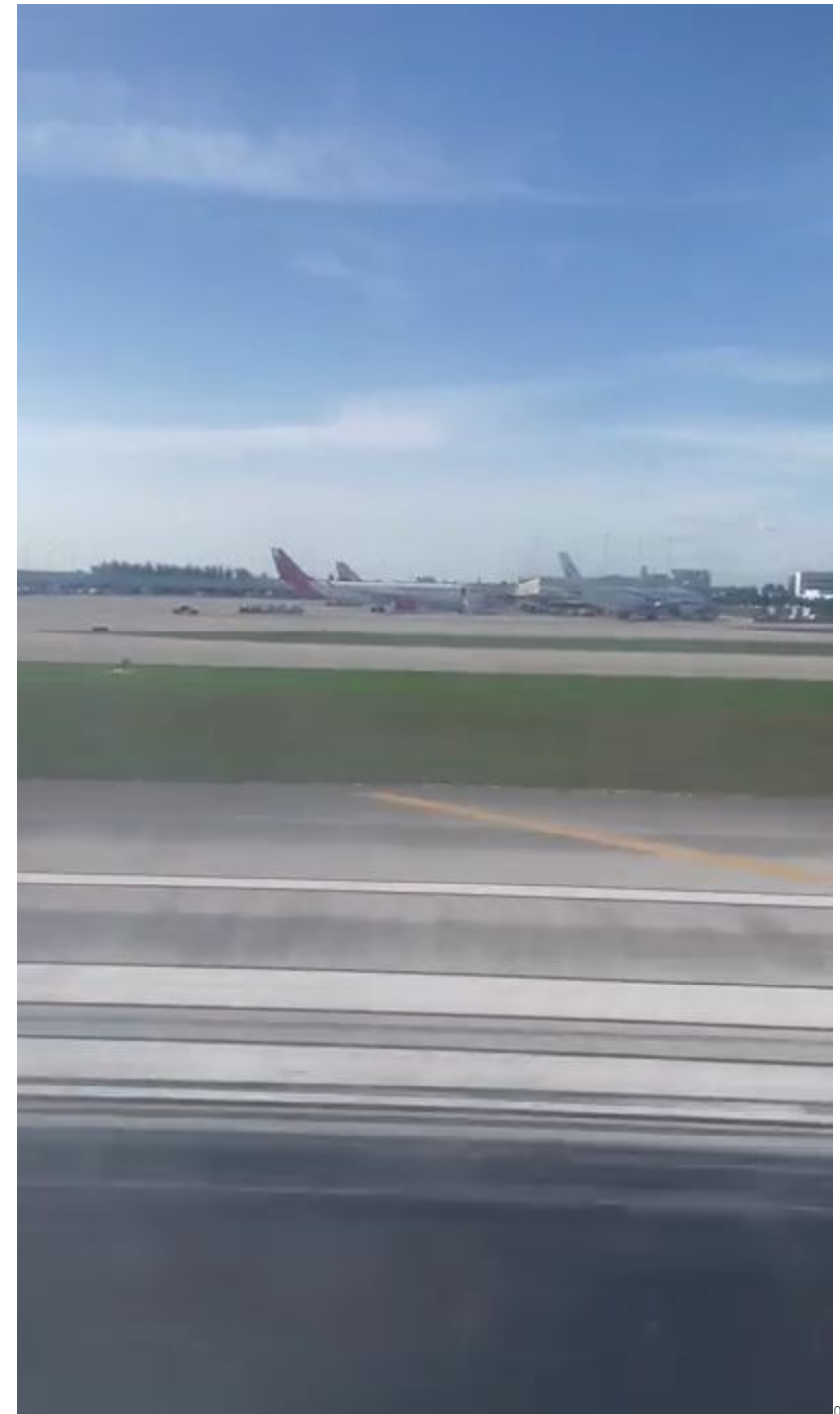

00177



00178

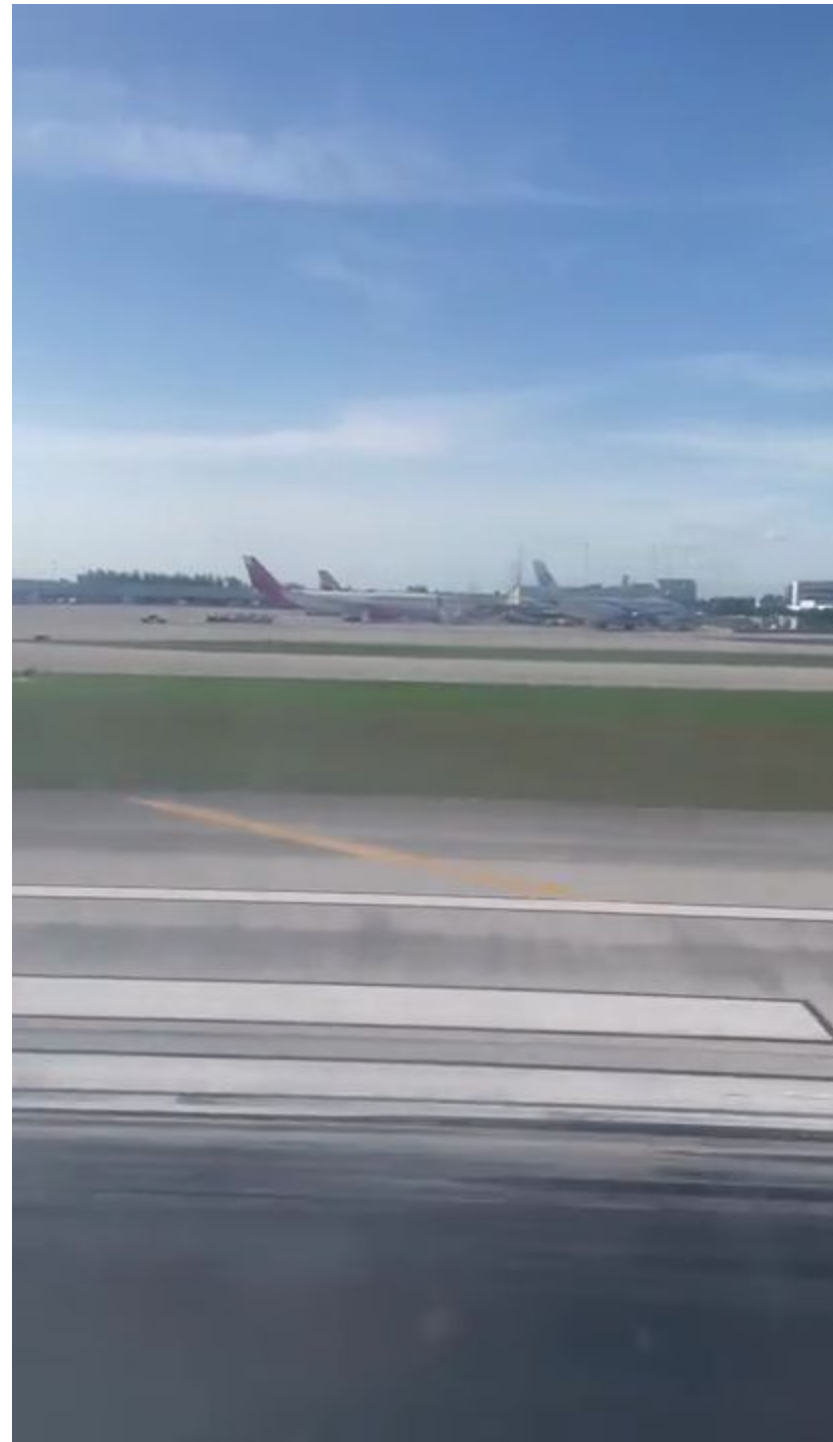

00179

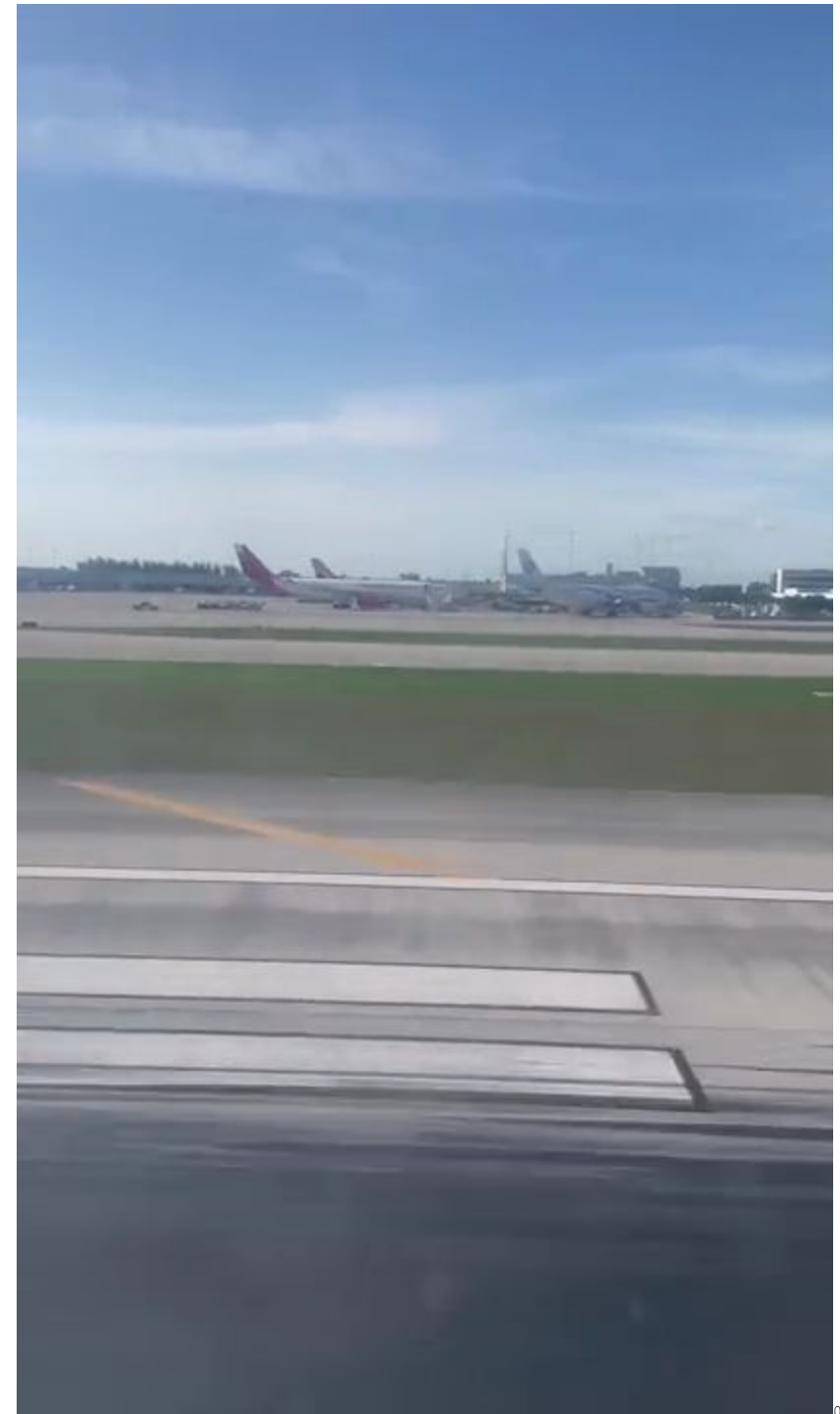

00180



00181



00182



00183



00184



00185

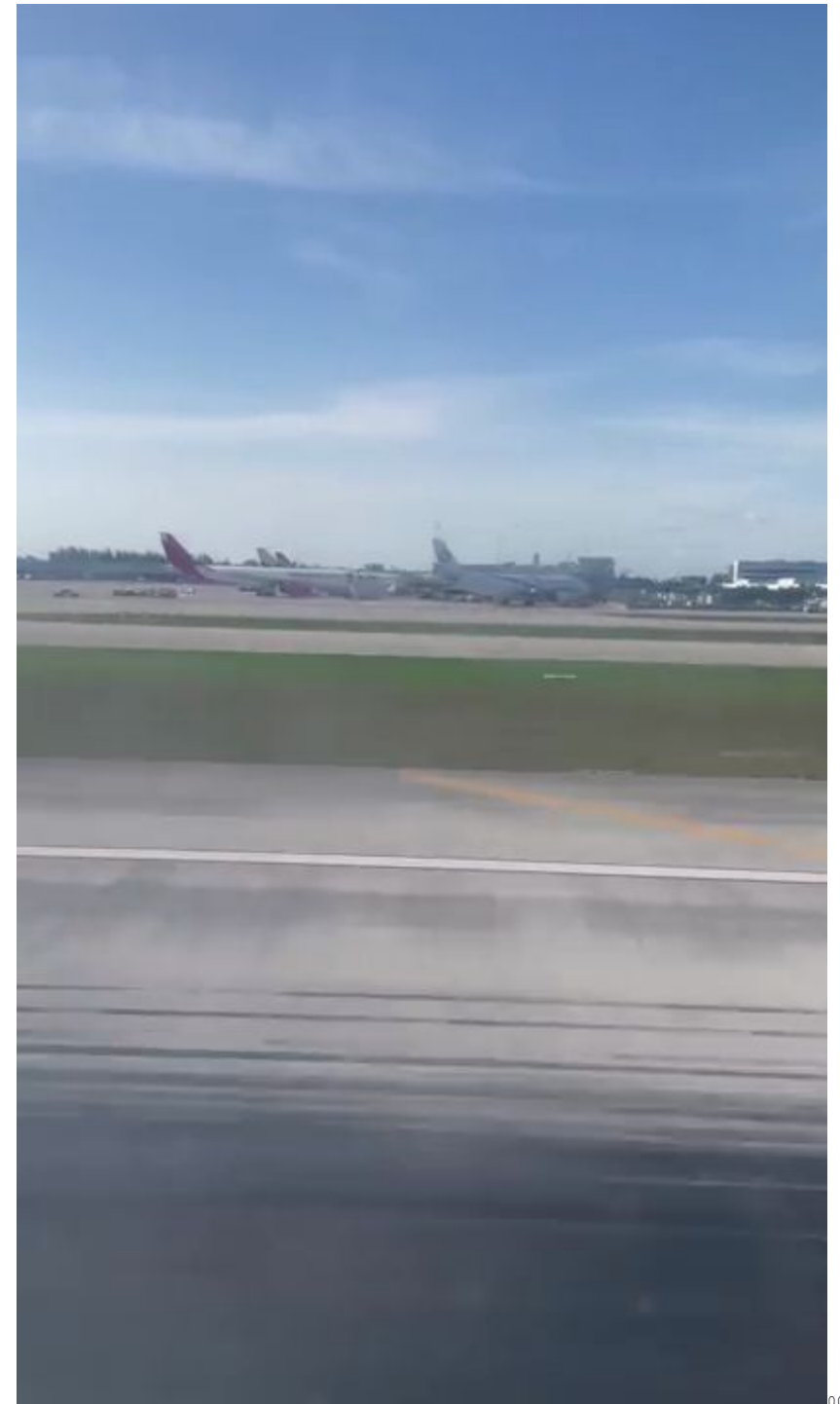

00186



00187



00188

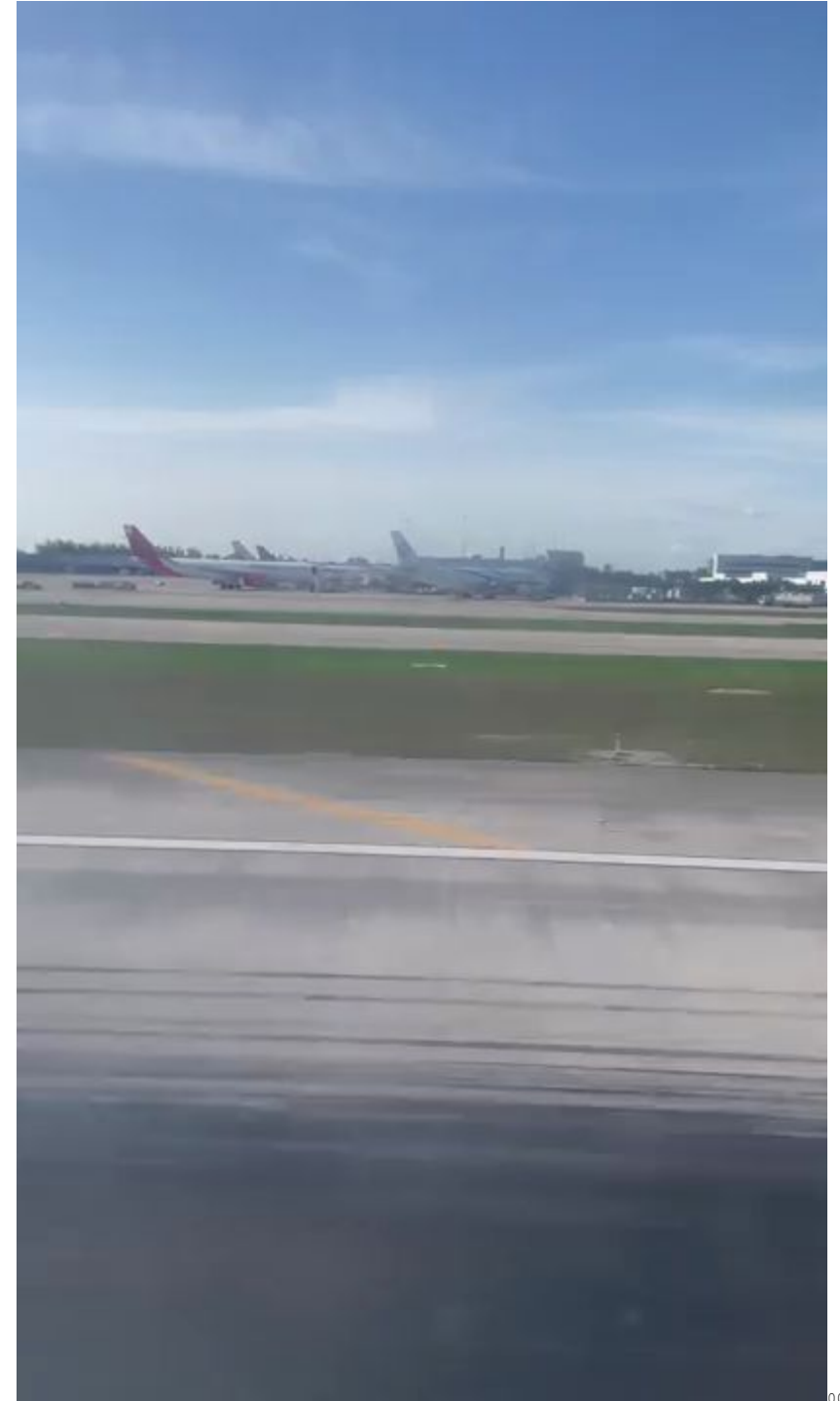

00189



00190

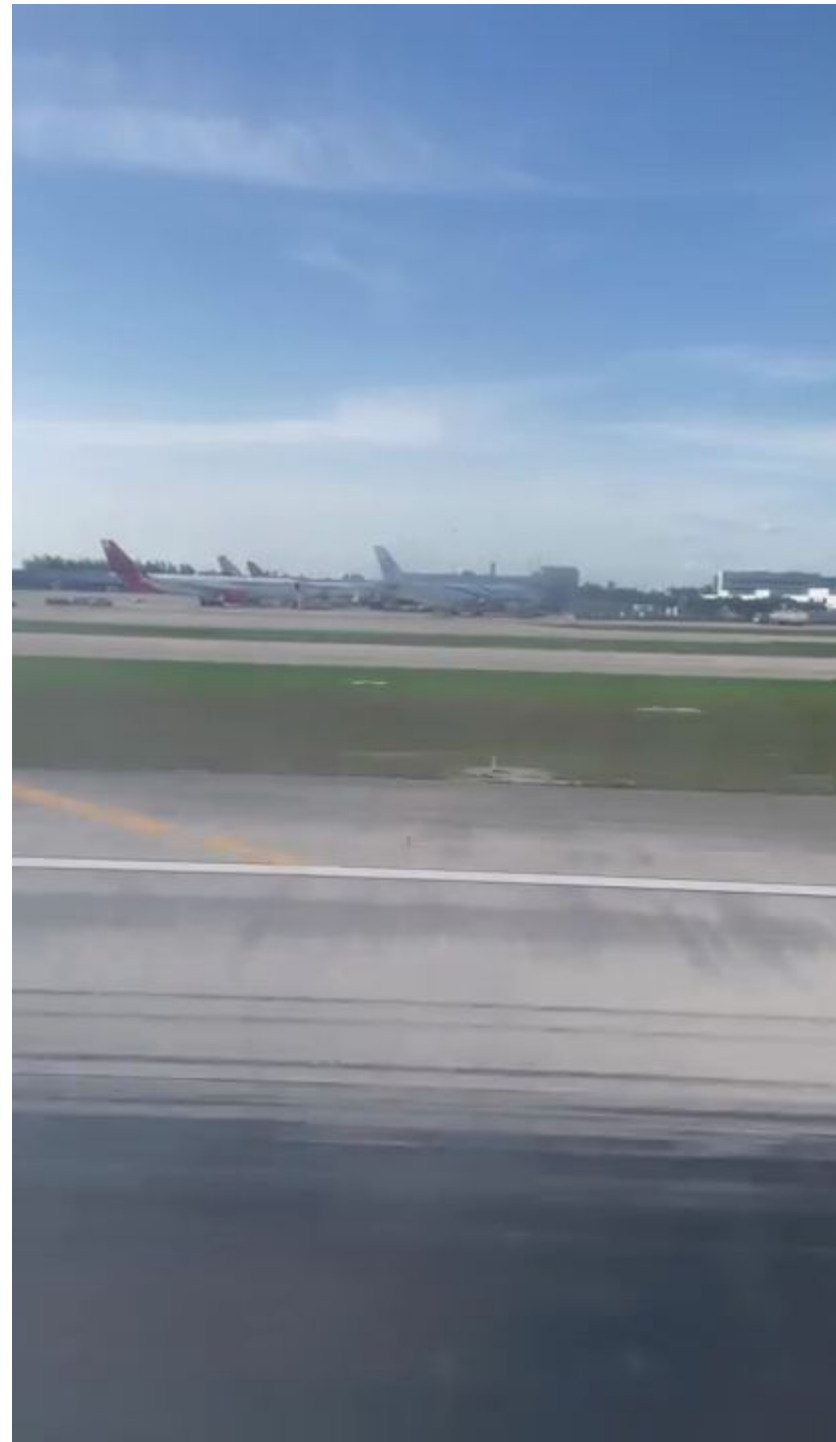

00191

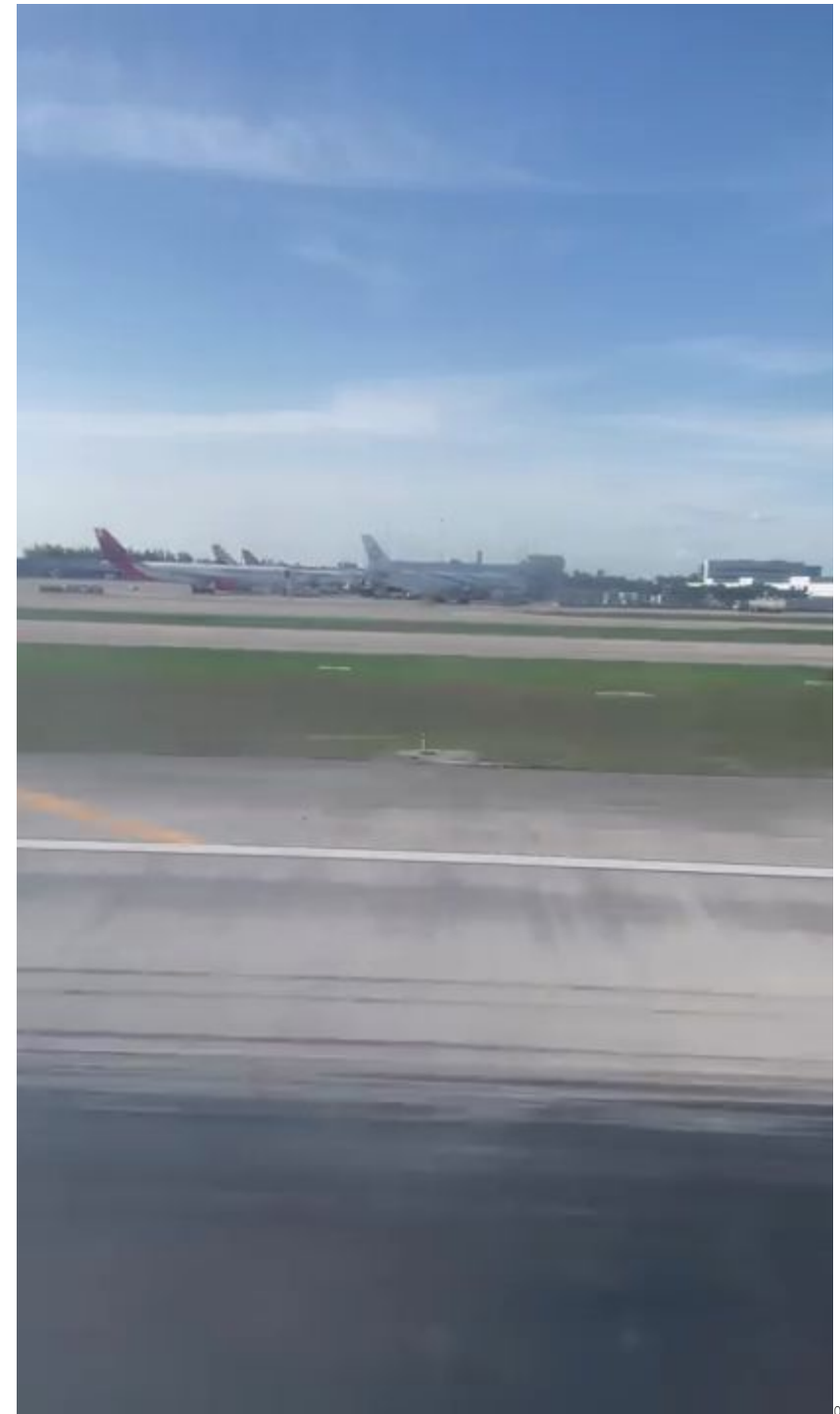

00192



00193

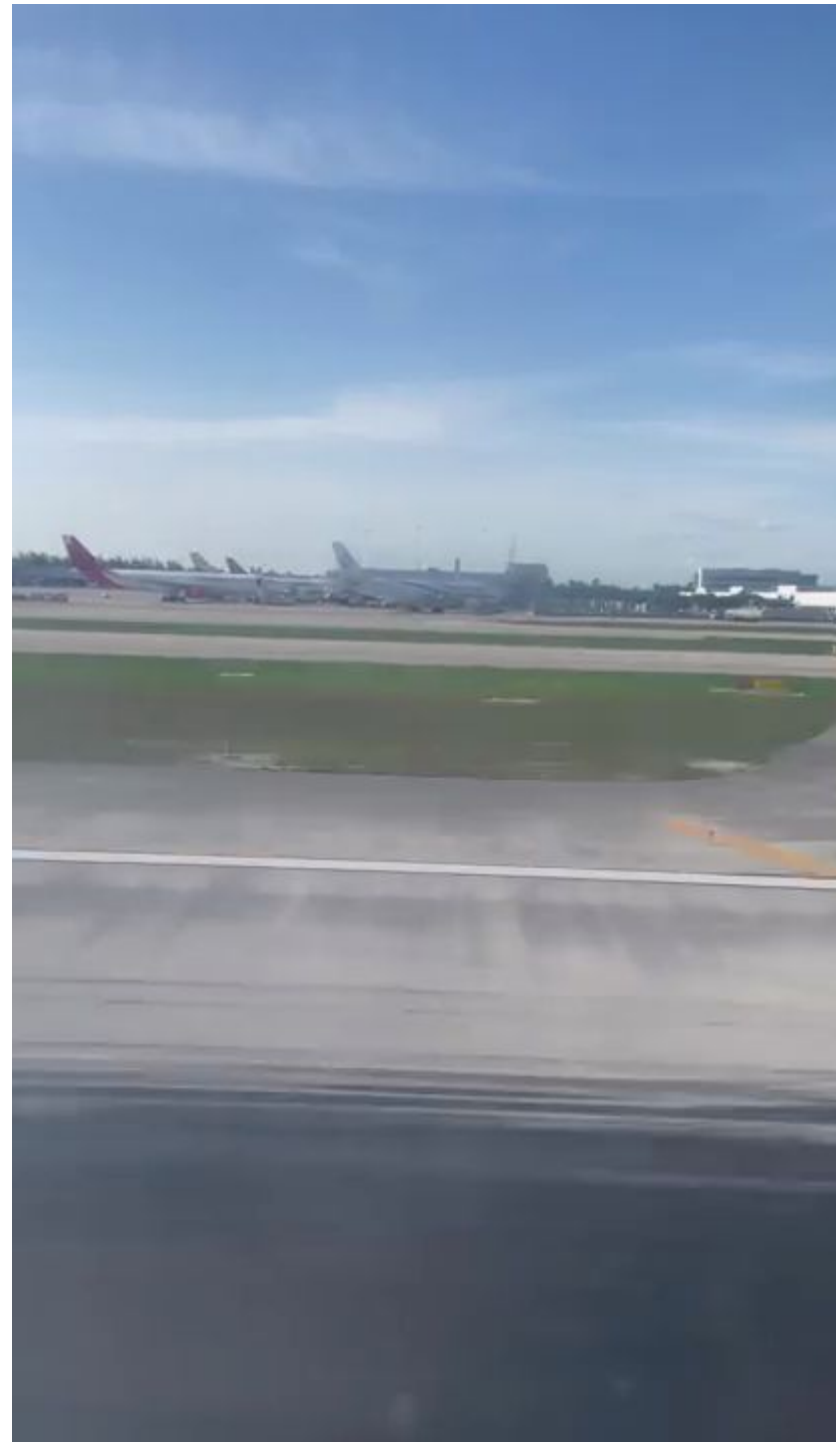

00194

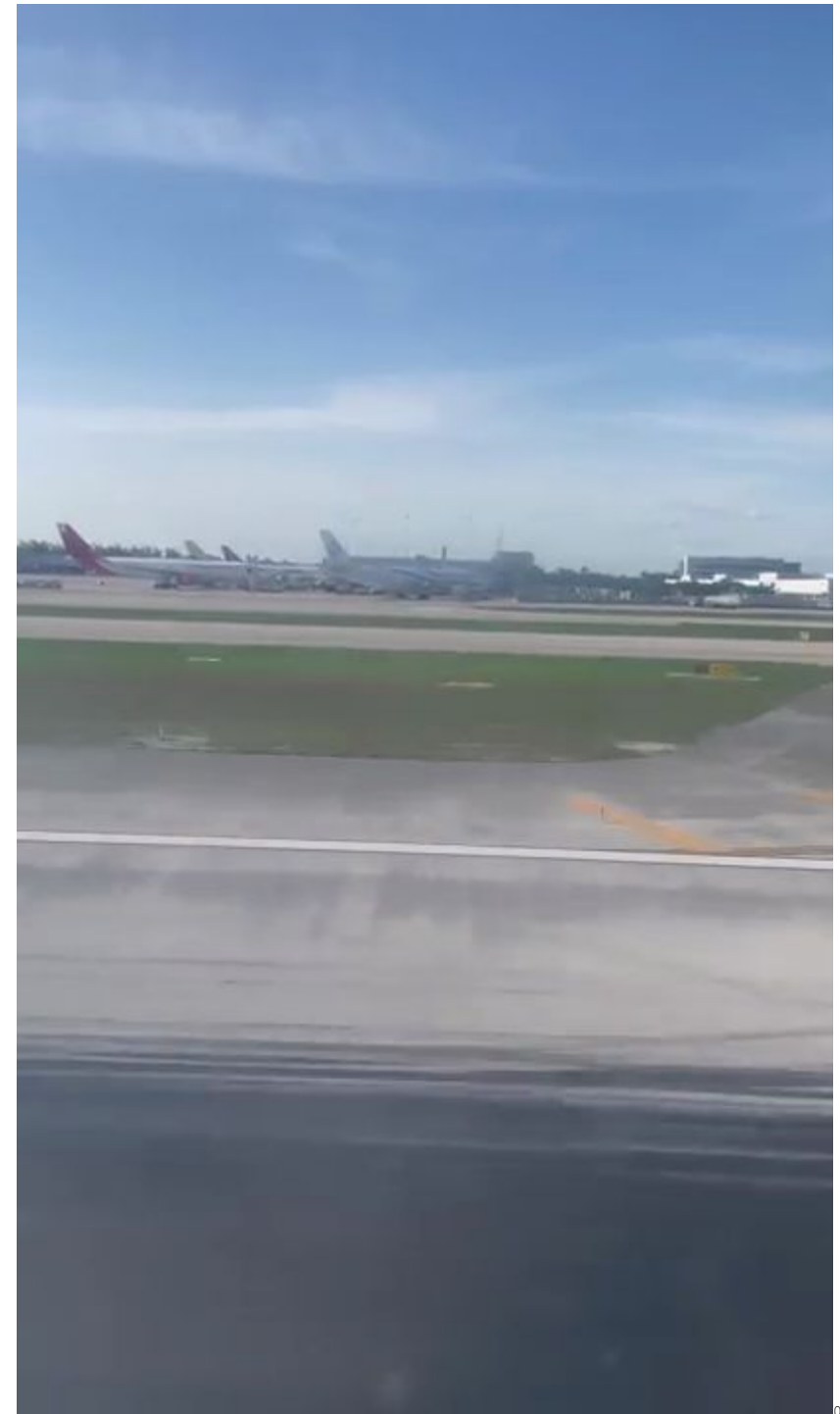

00195



00196



00197

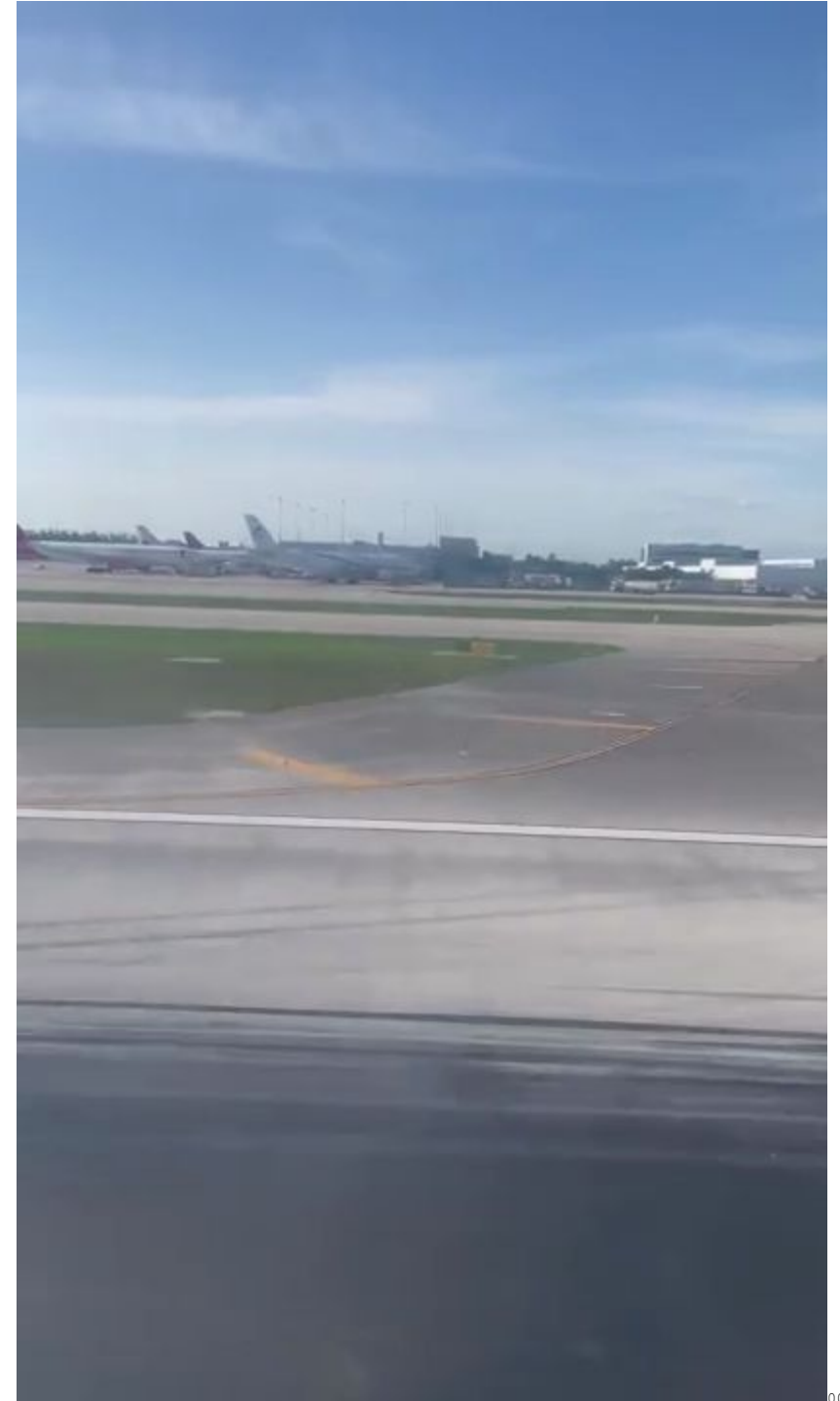

00198



00199



00200



00201



00202



00203

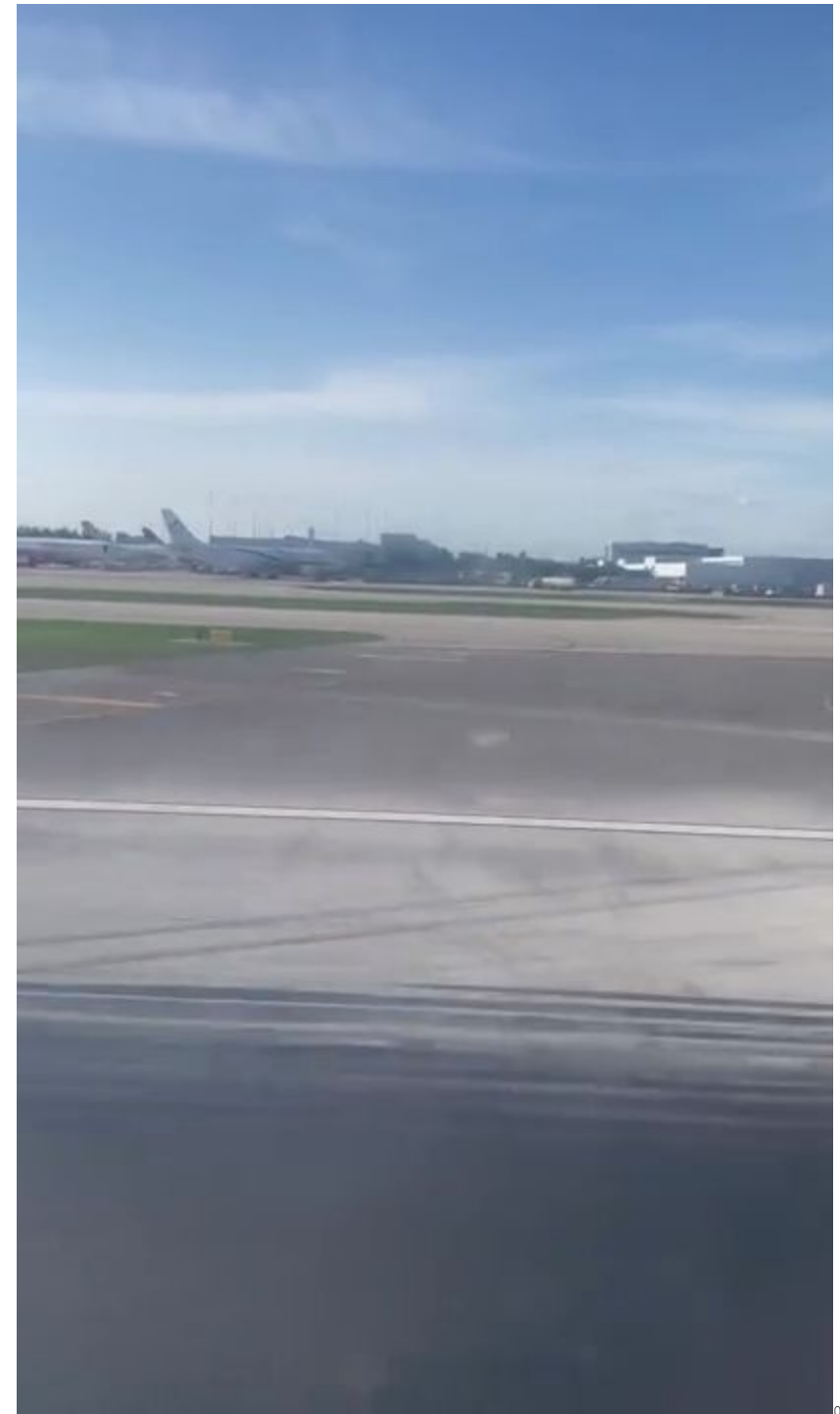

00204



00205



00206

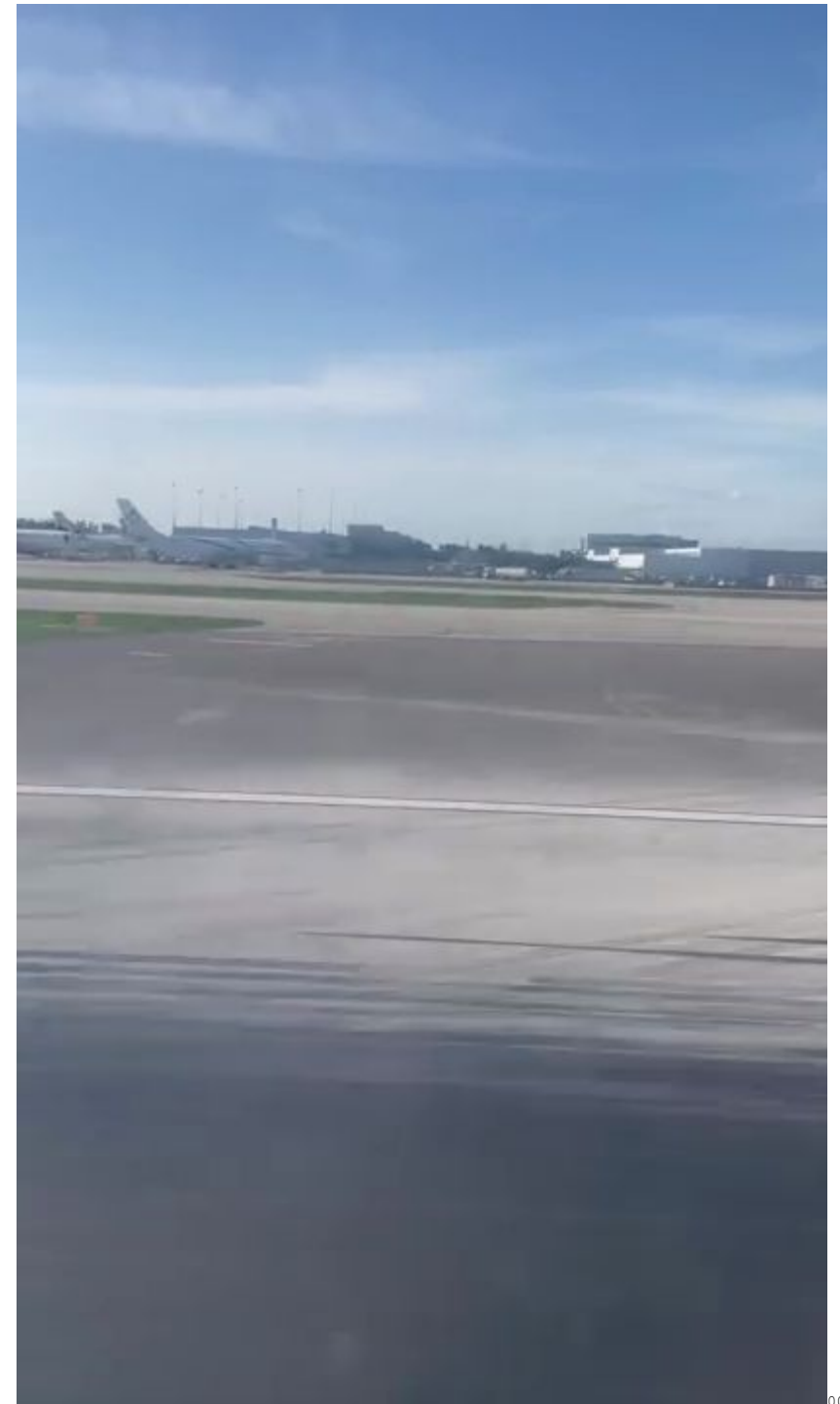

00207

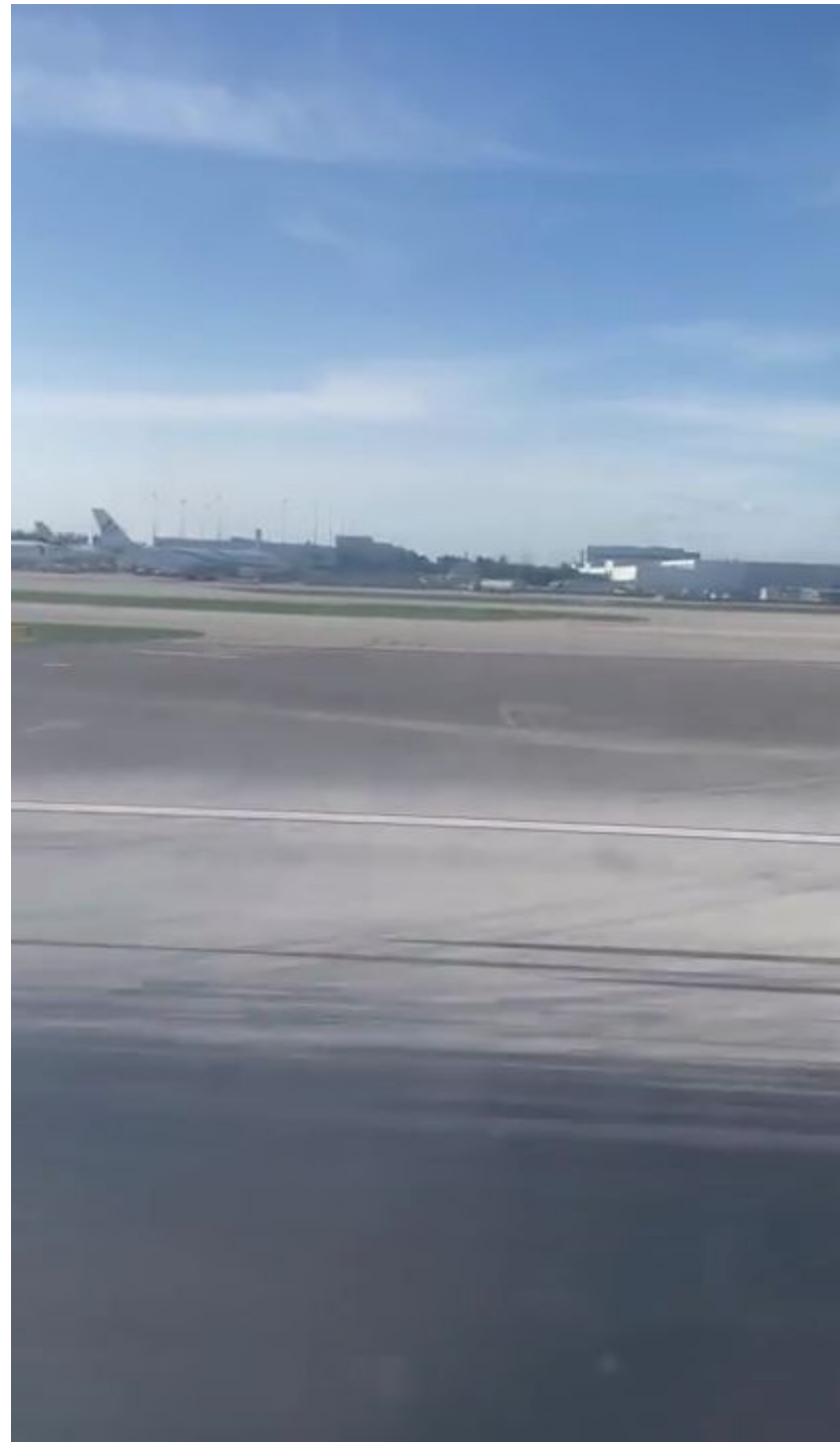

00208



00209

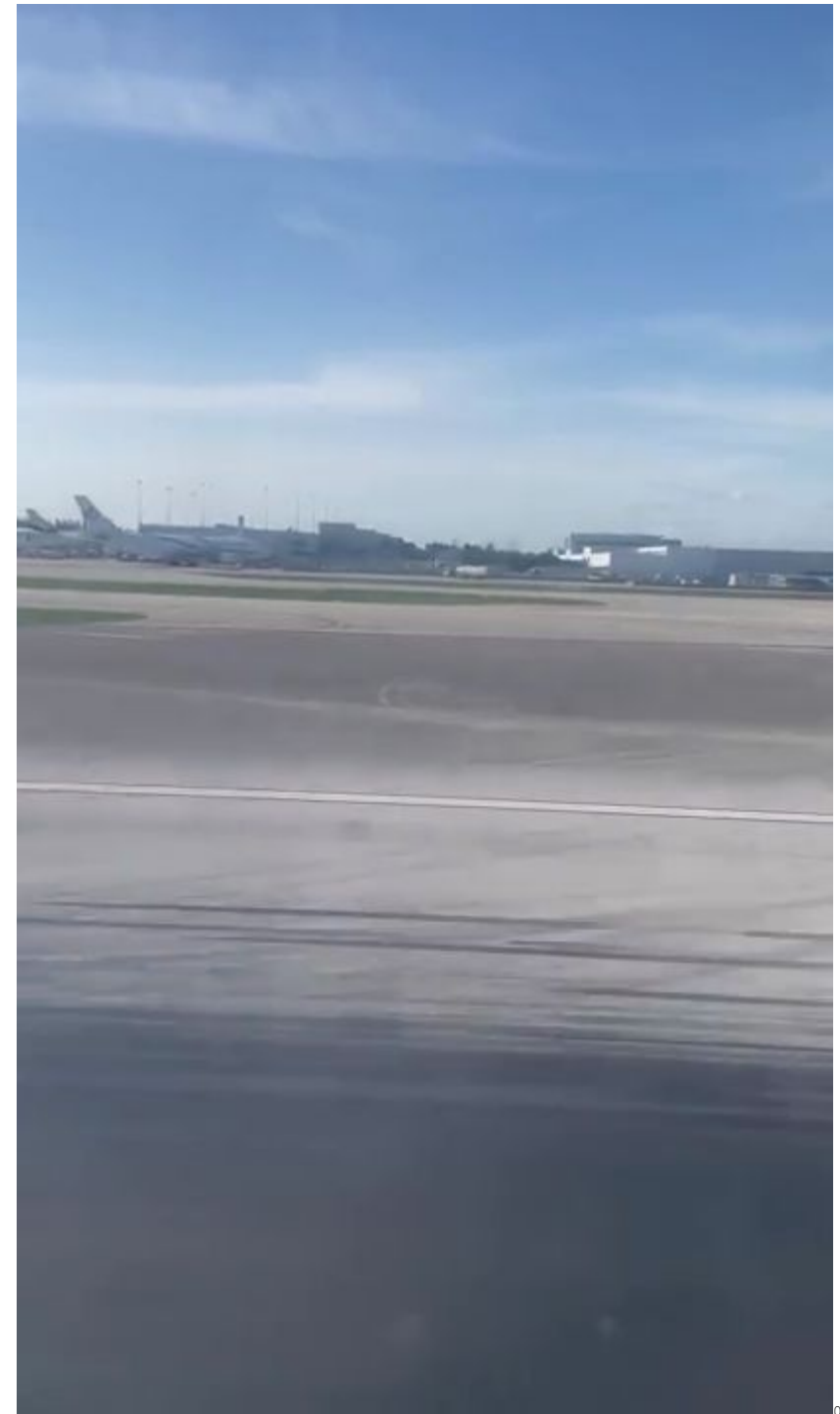

00210



00211



00212

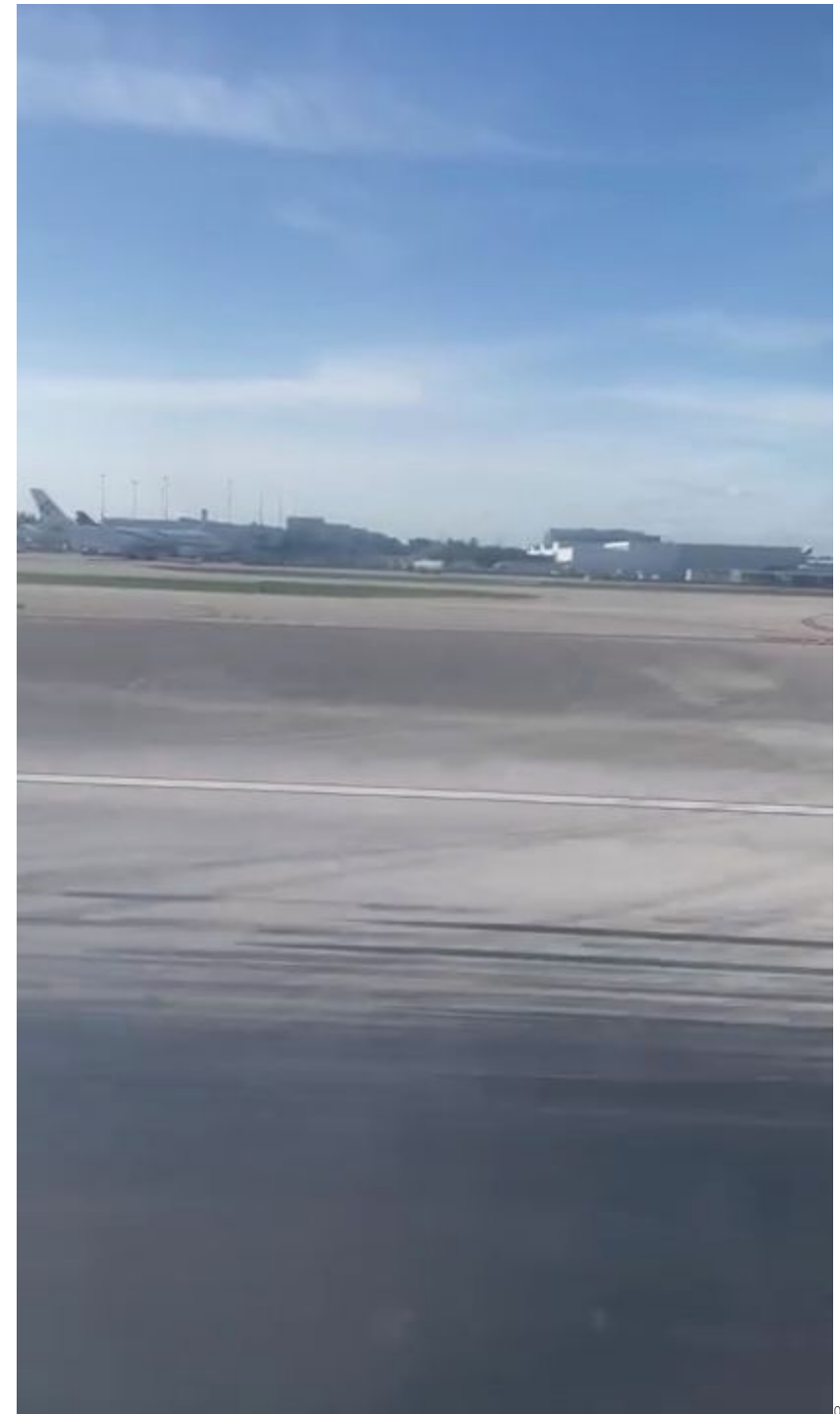

00213



00214



00215

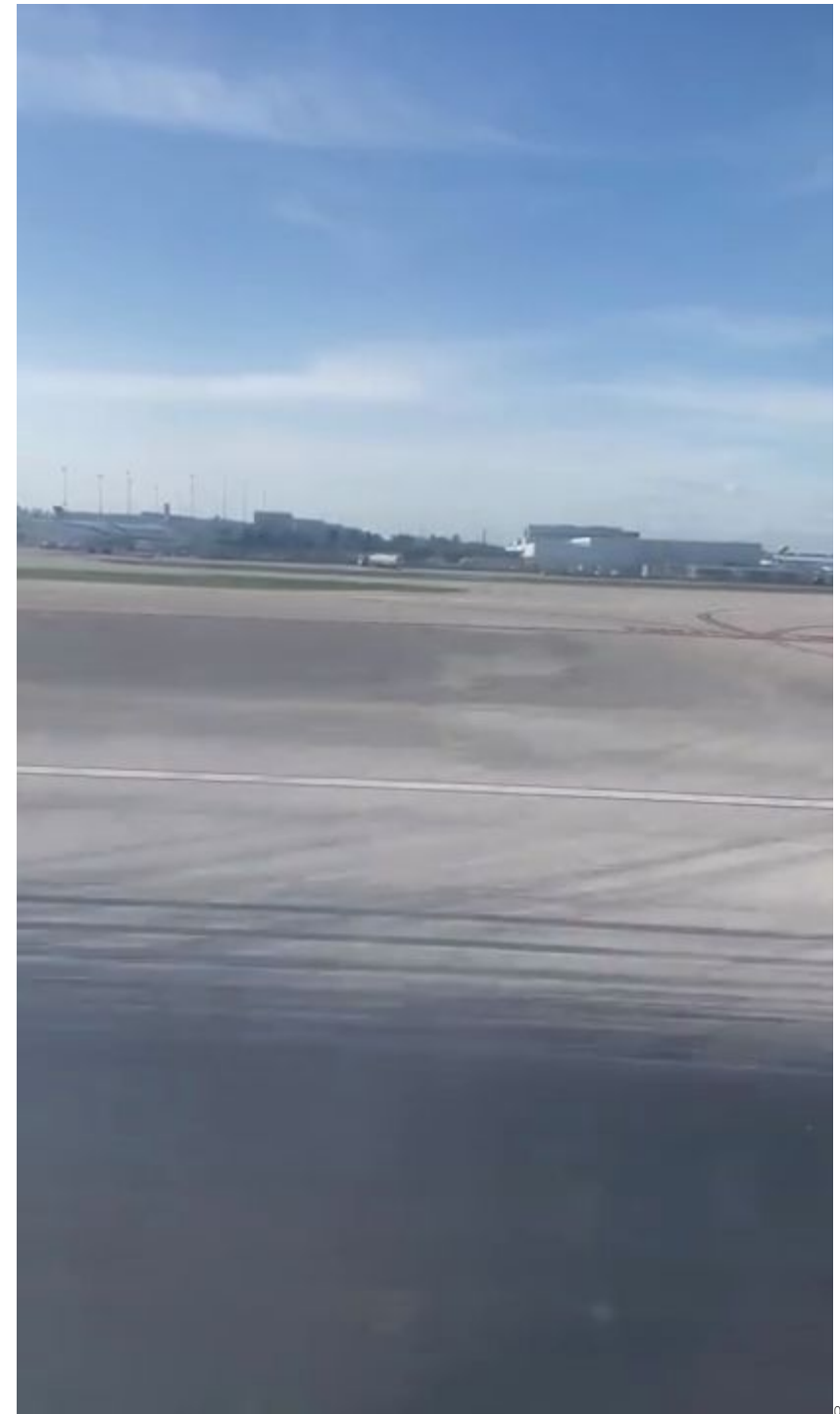

00216



00217



00218

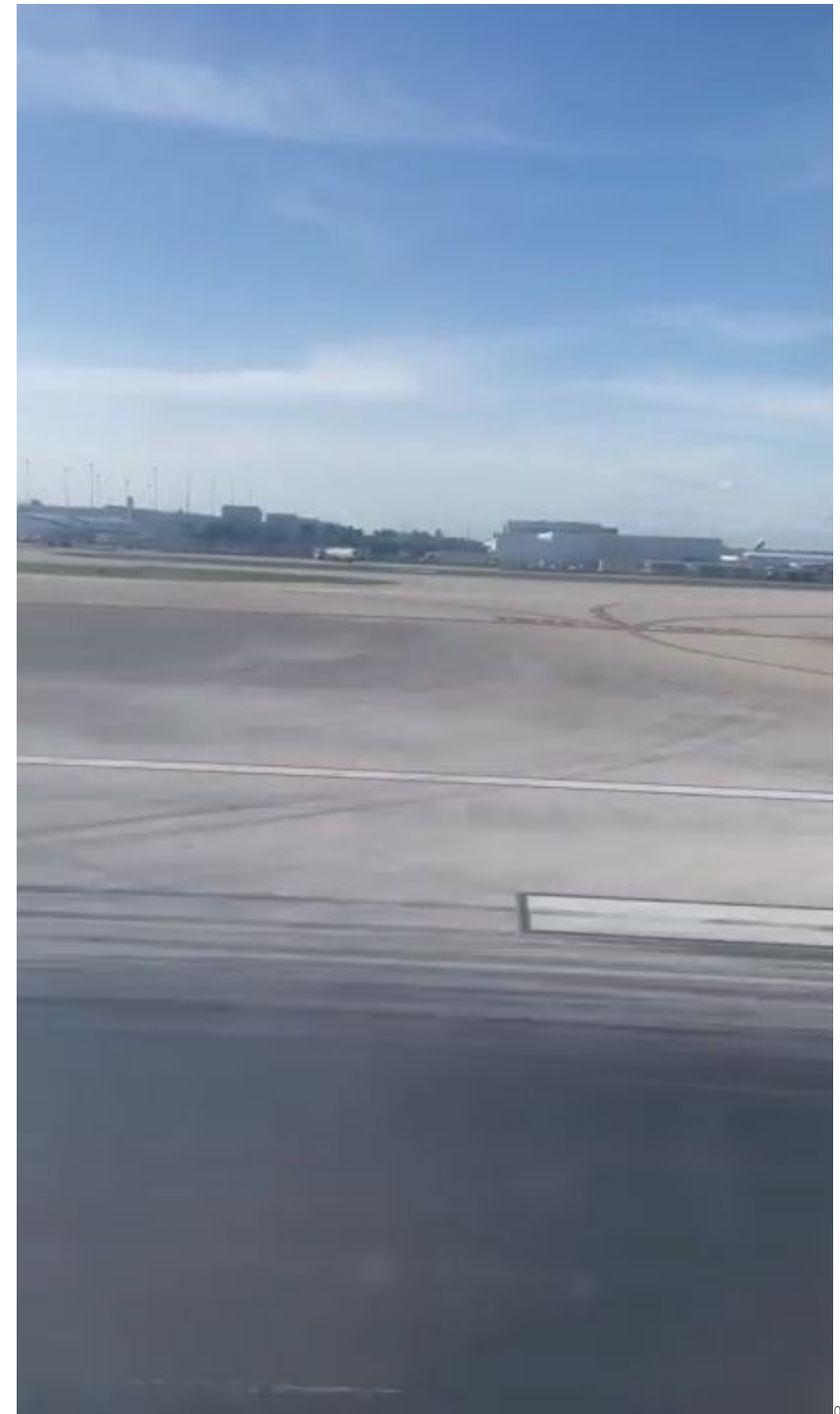

00219



00220

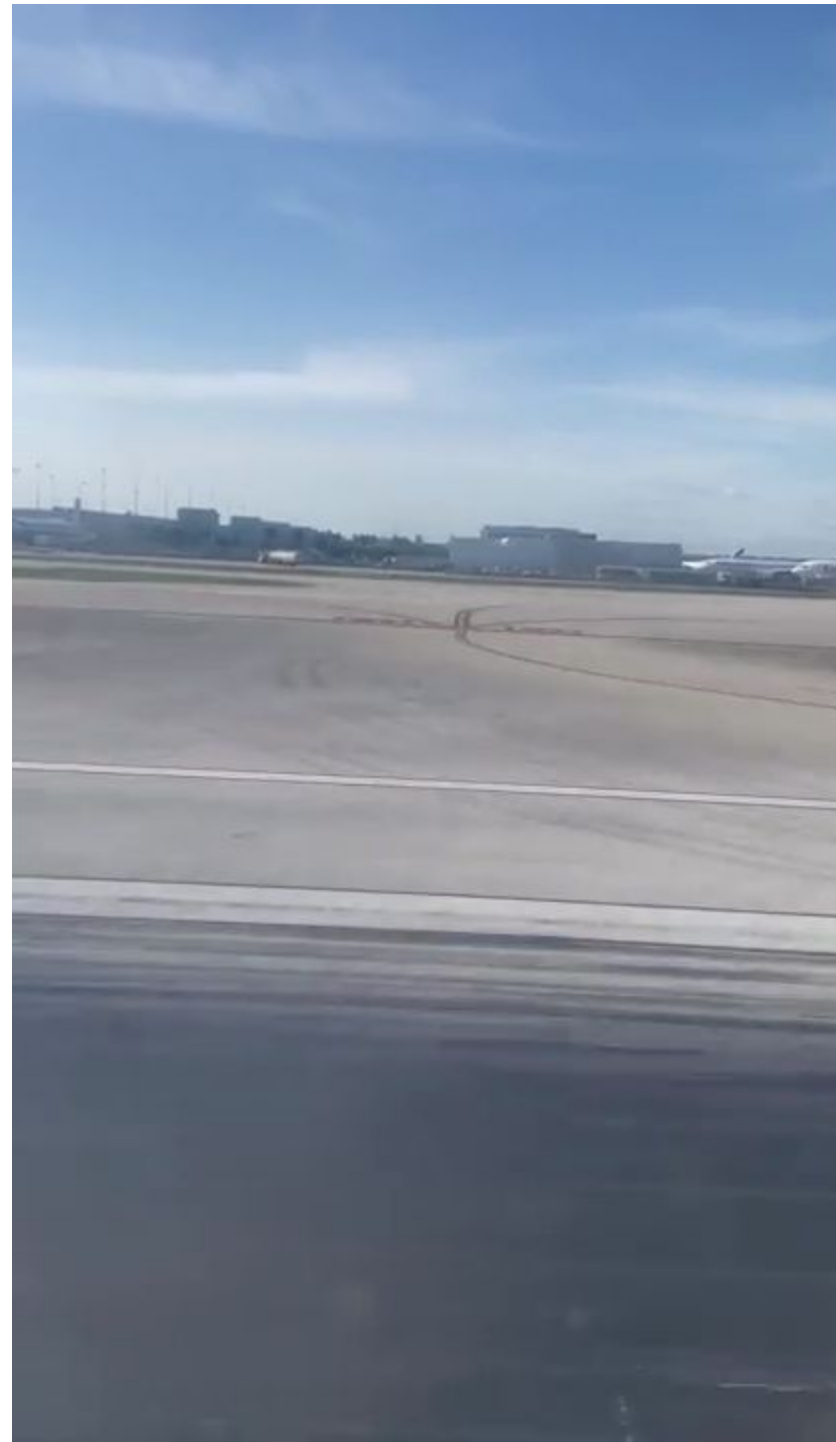

00221

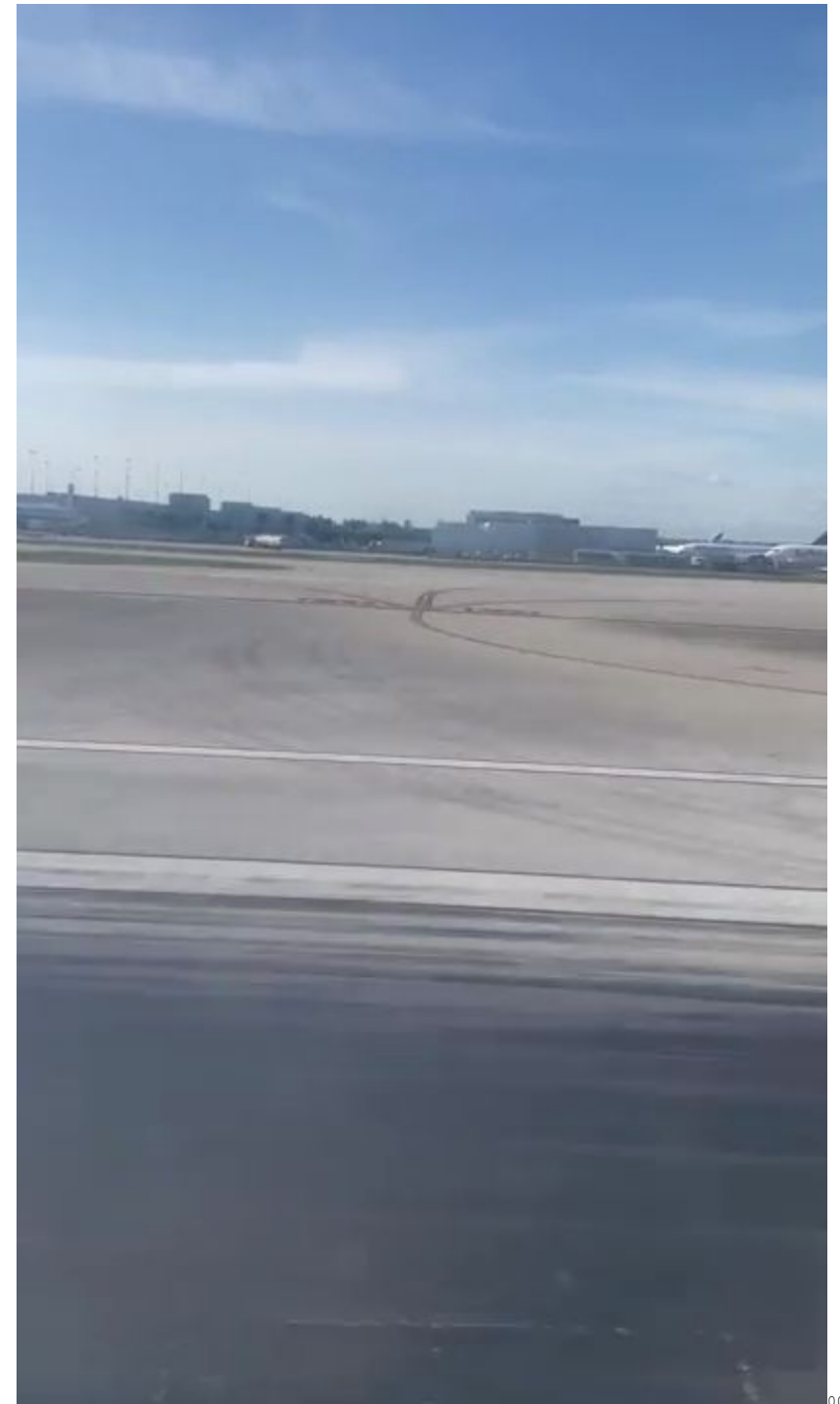

00222



00223



00224

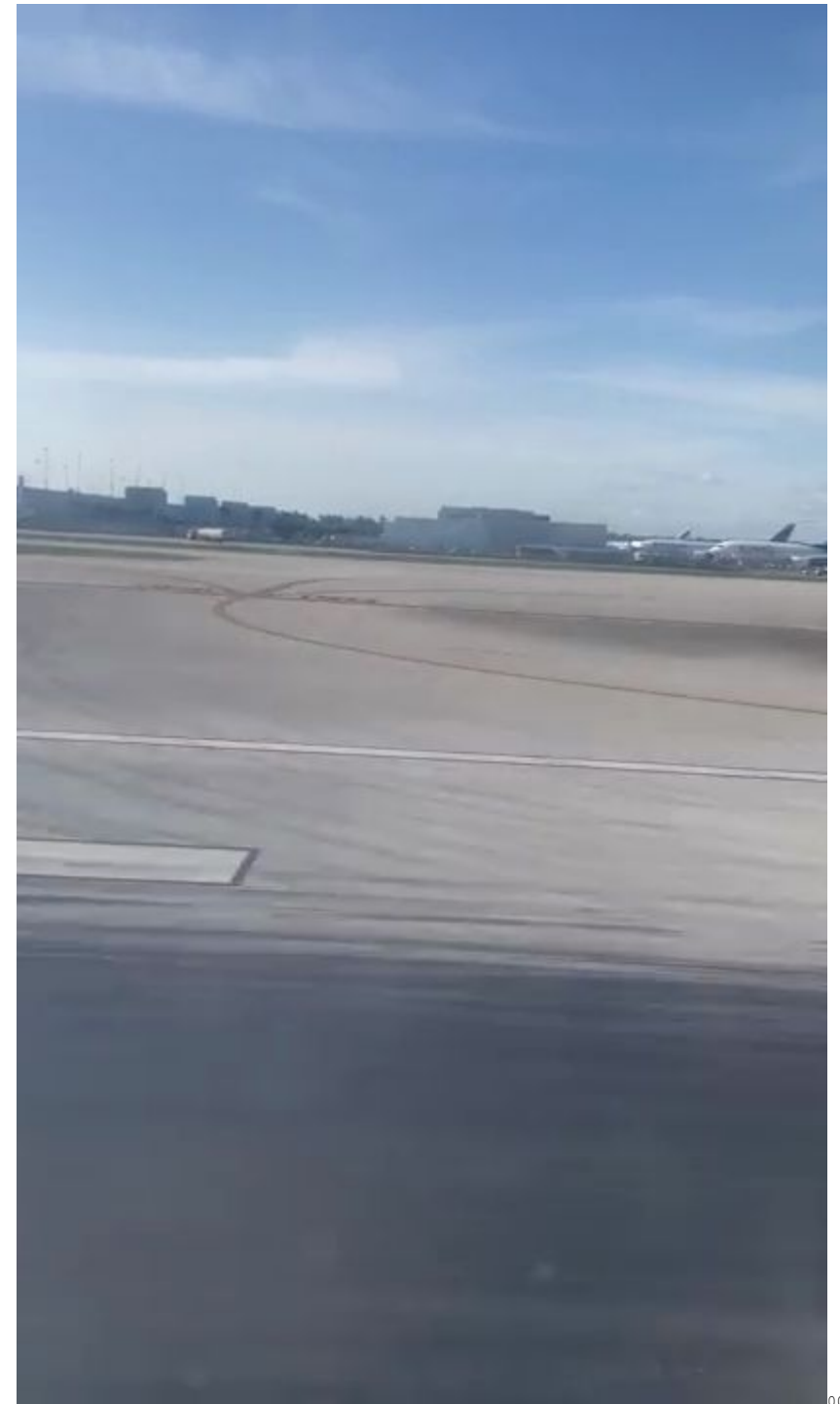

00225



00226



00227

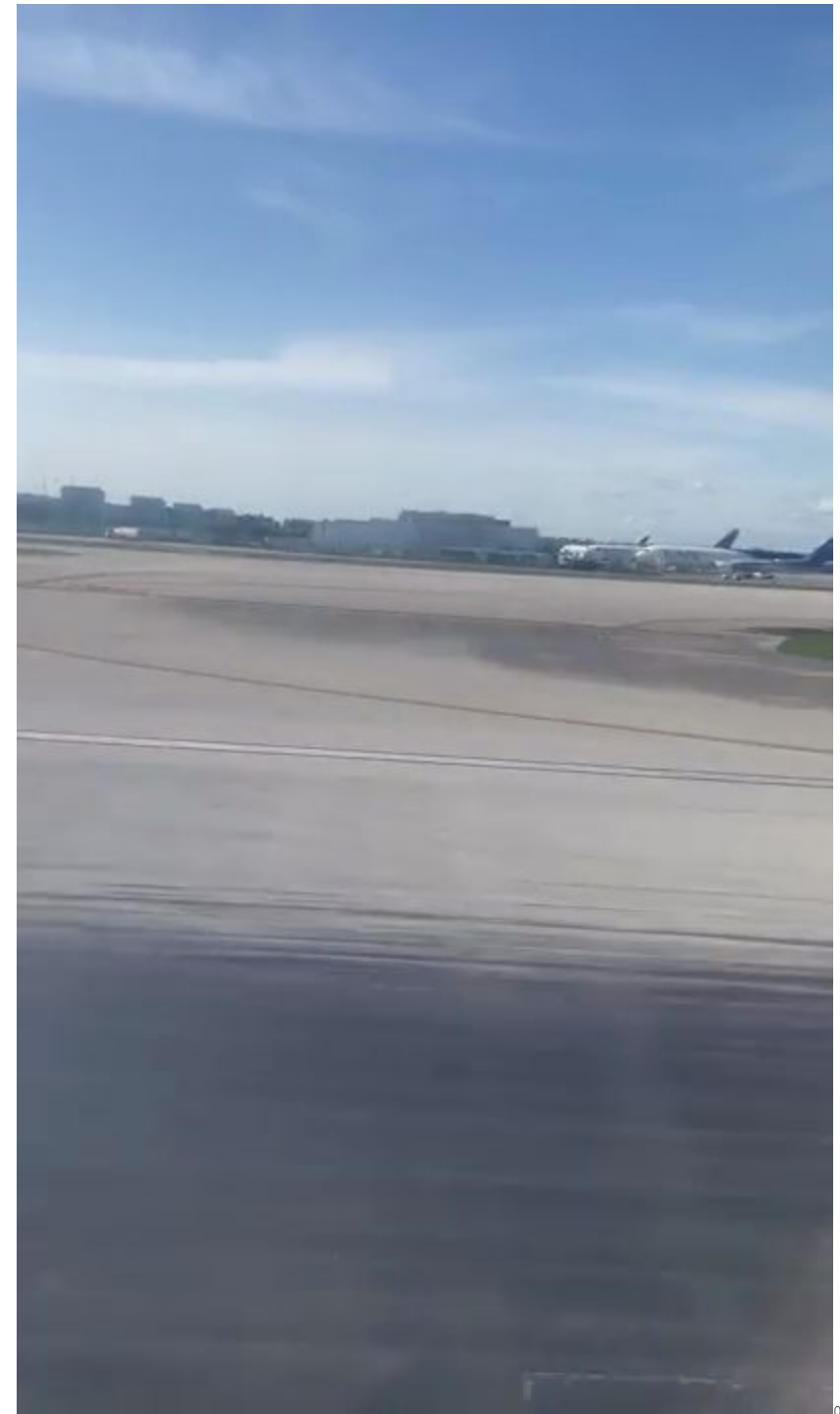

00228



00229



00230

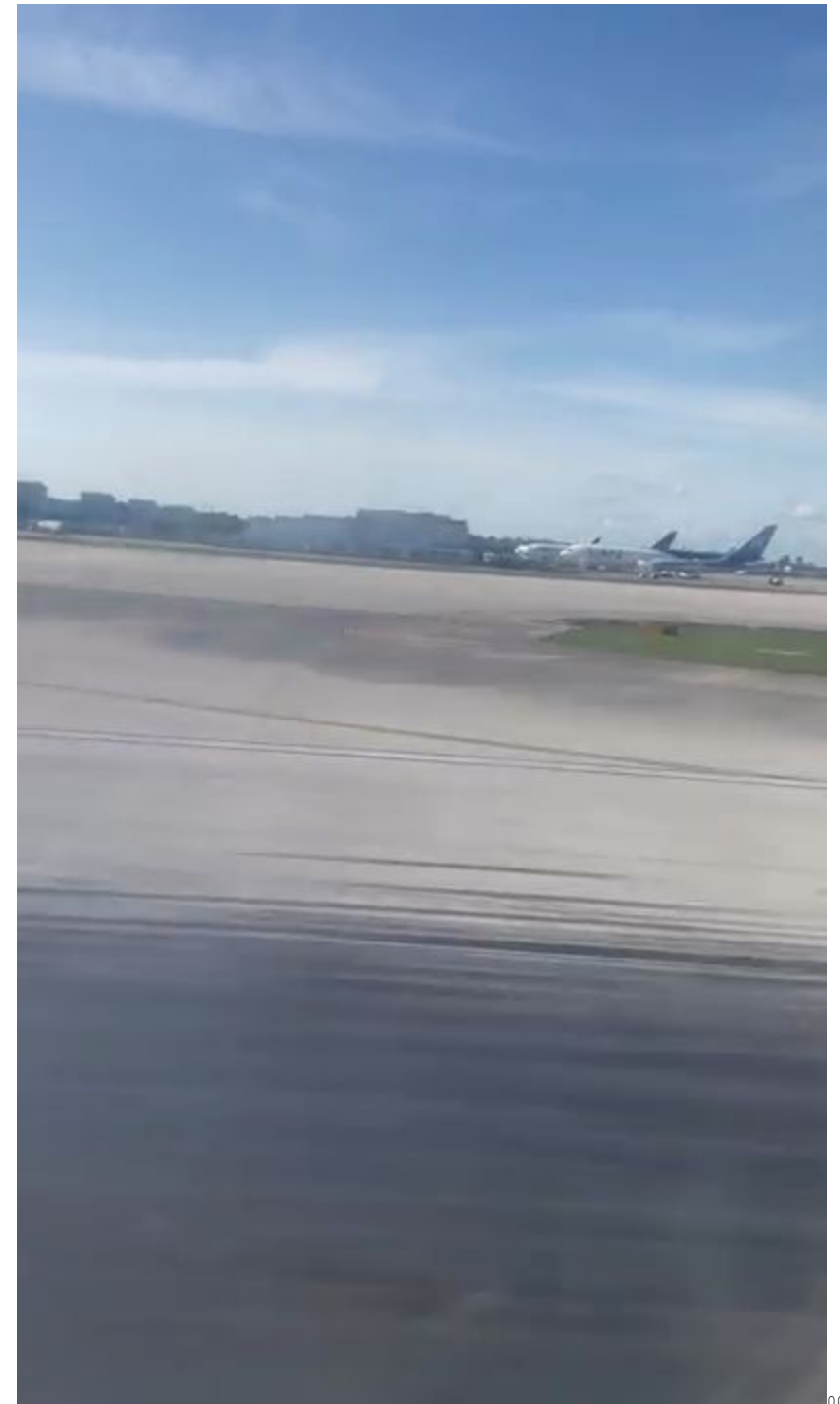

00231



00232



00233



00234



00235



00236

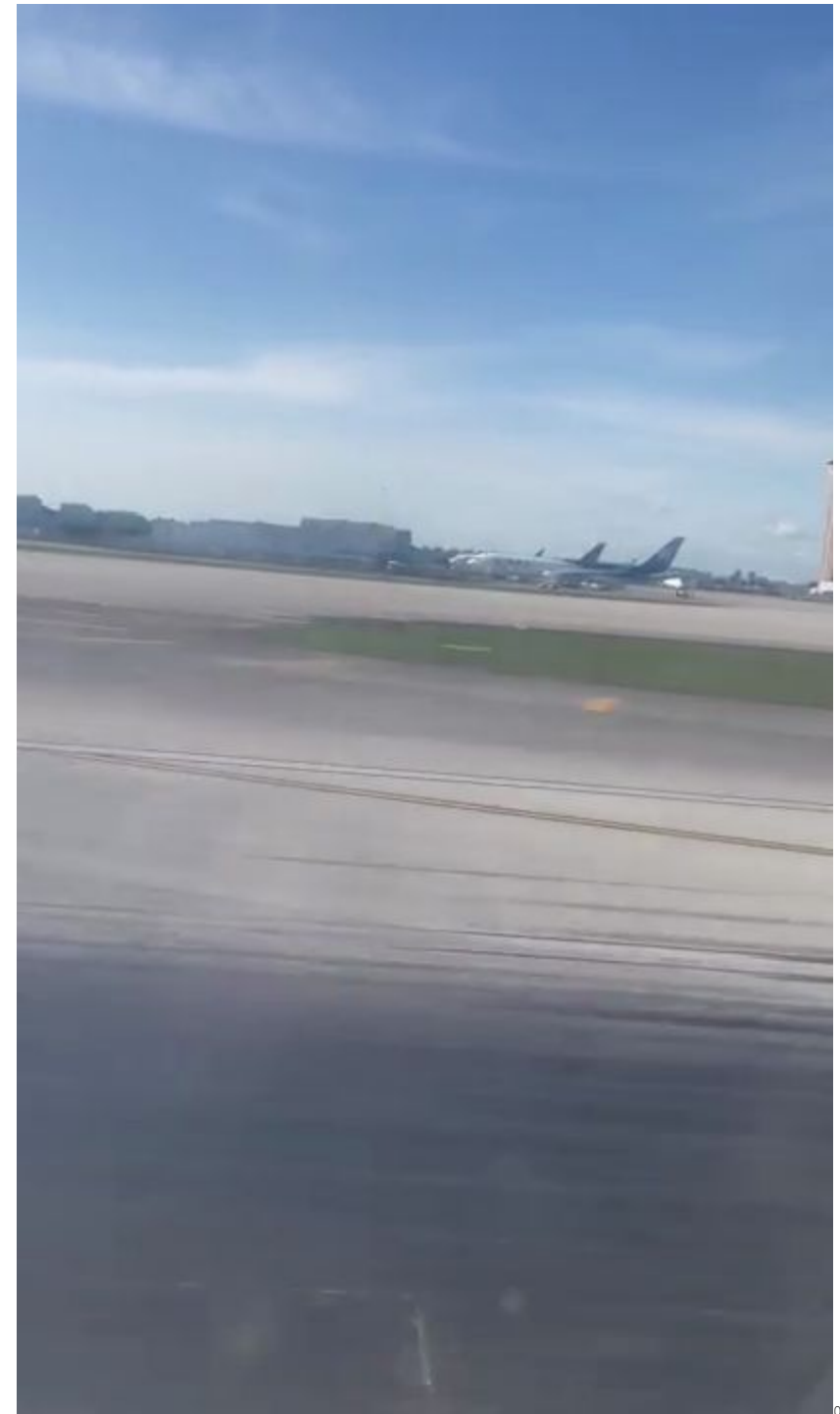

00237



00238

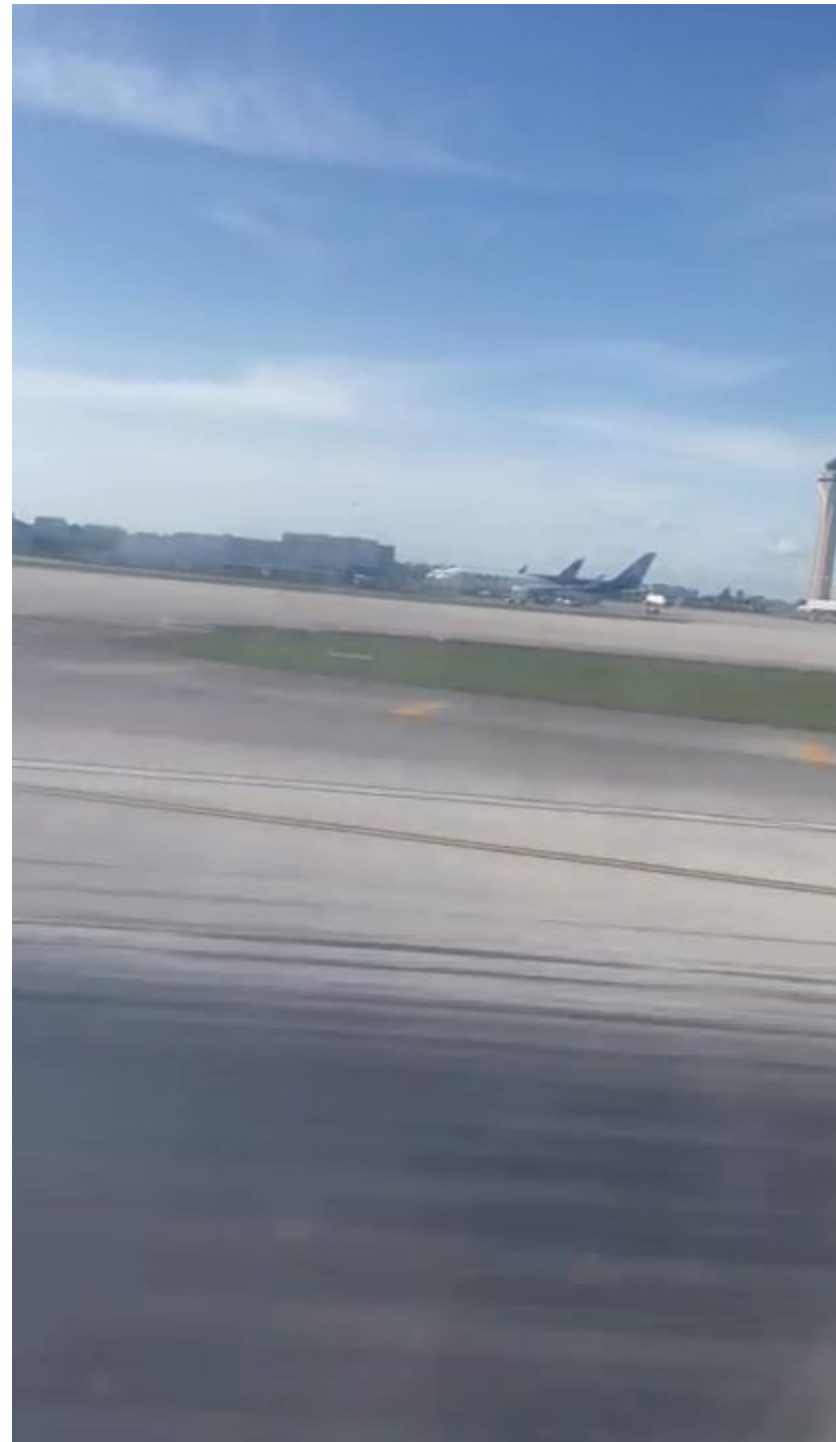

00239

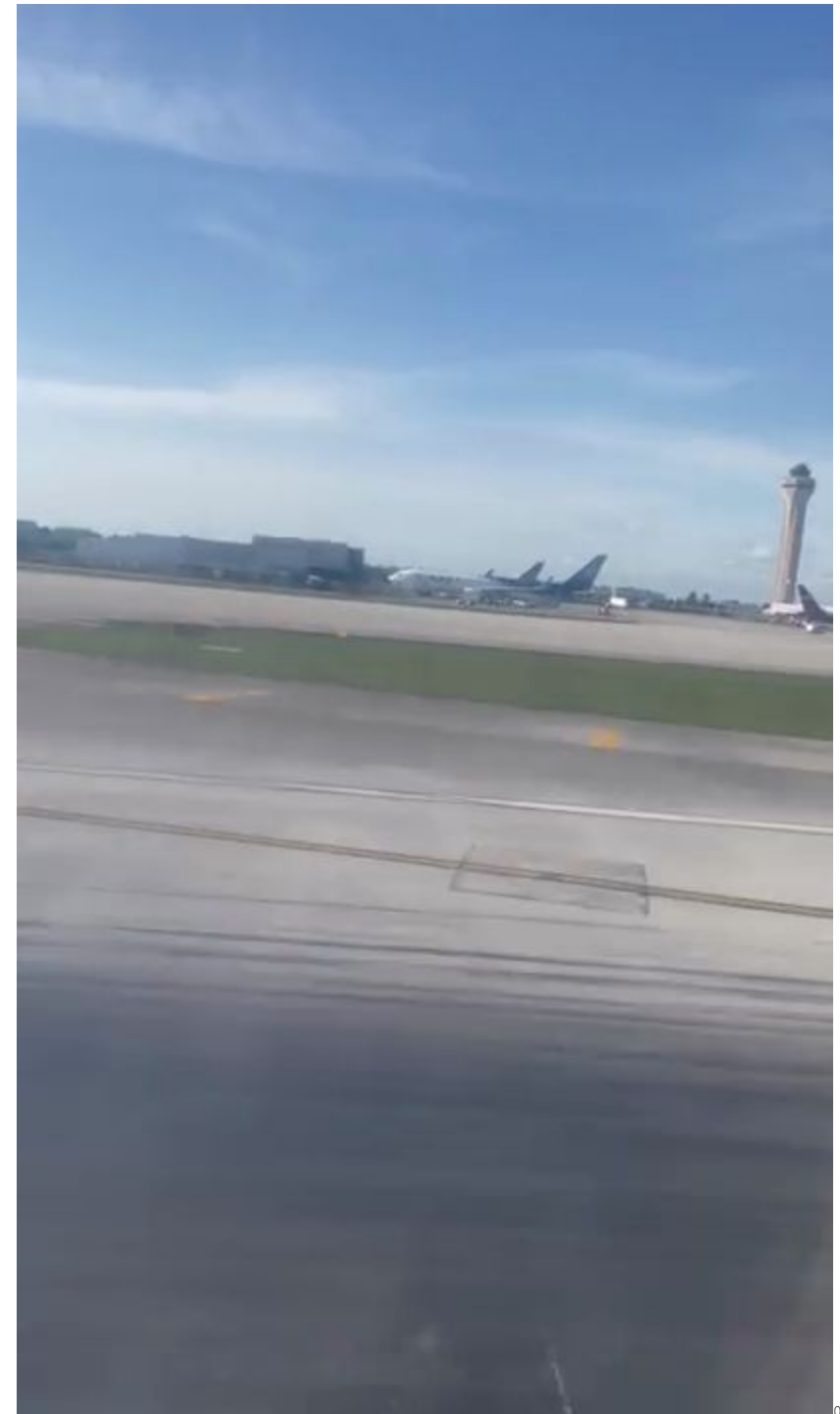

00240

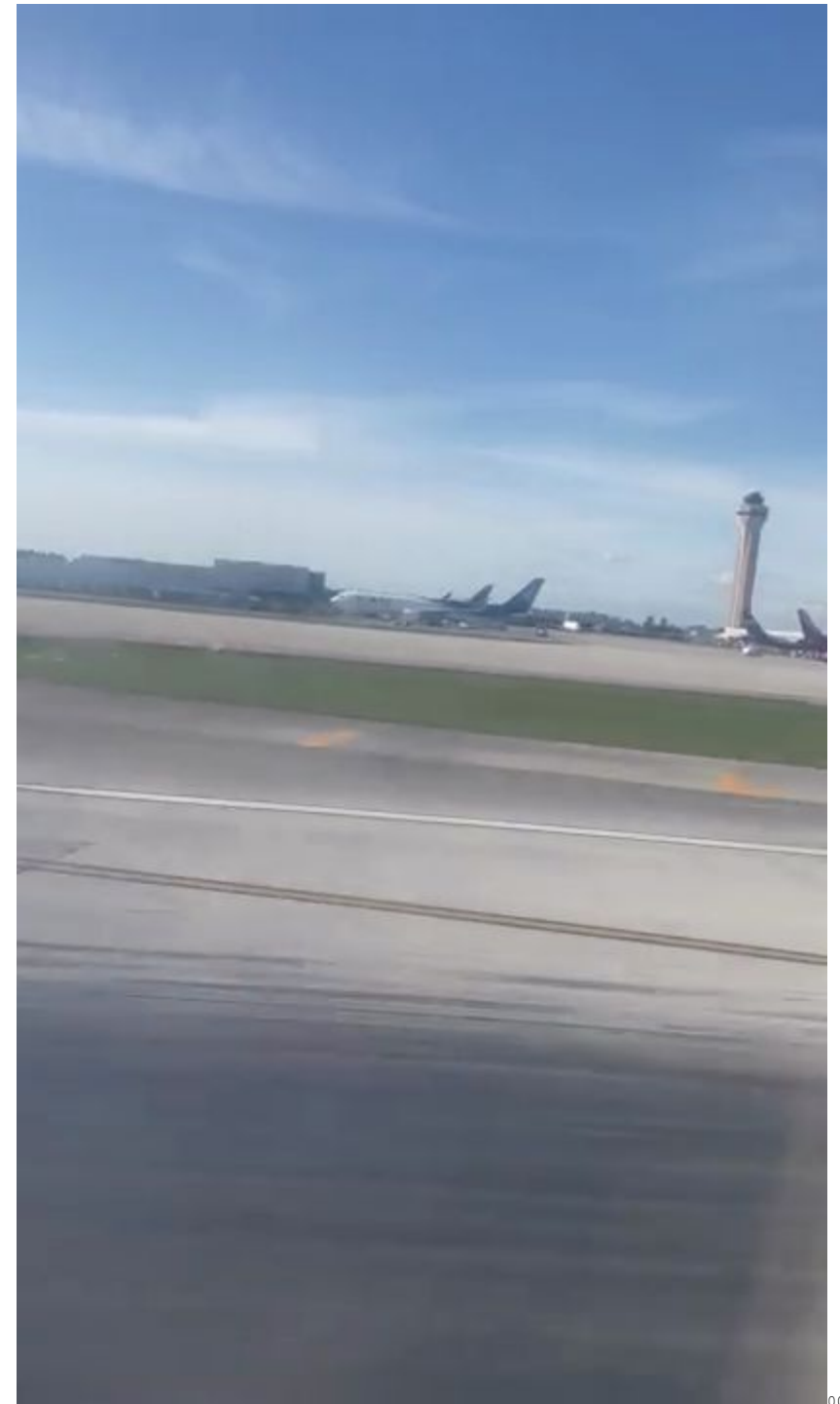
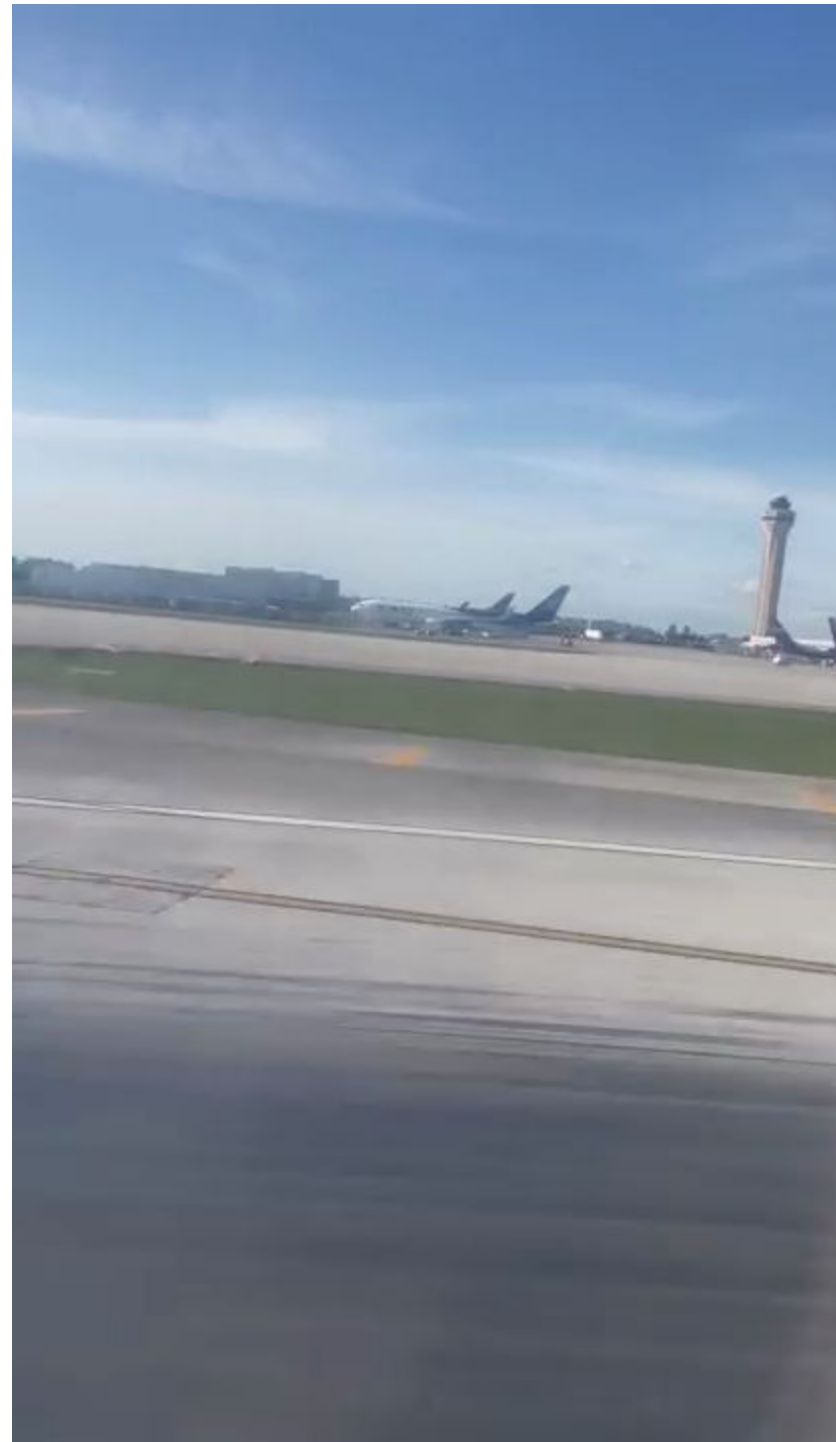
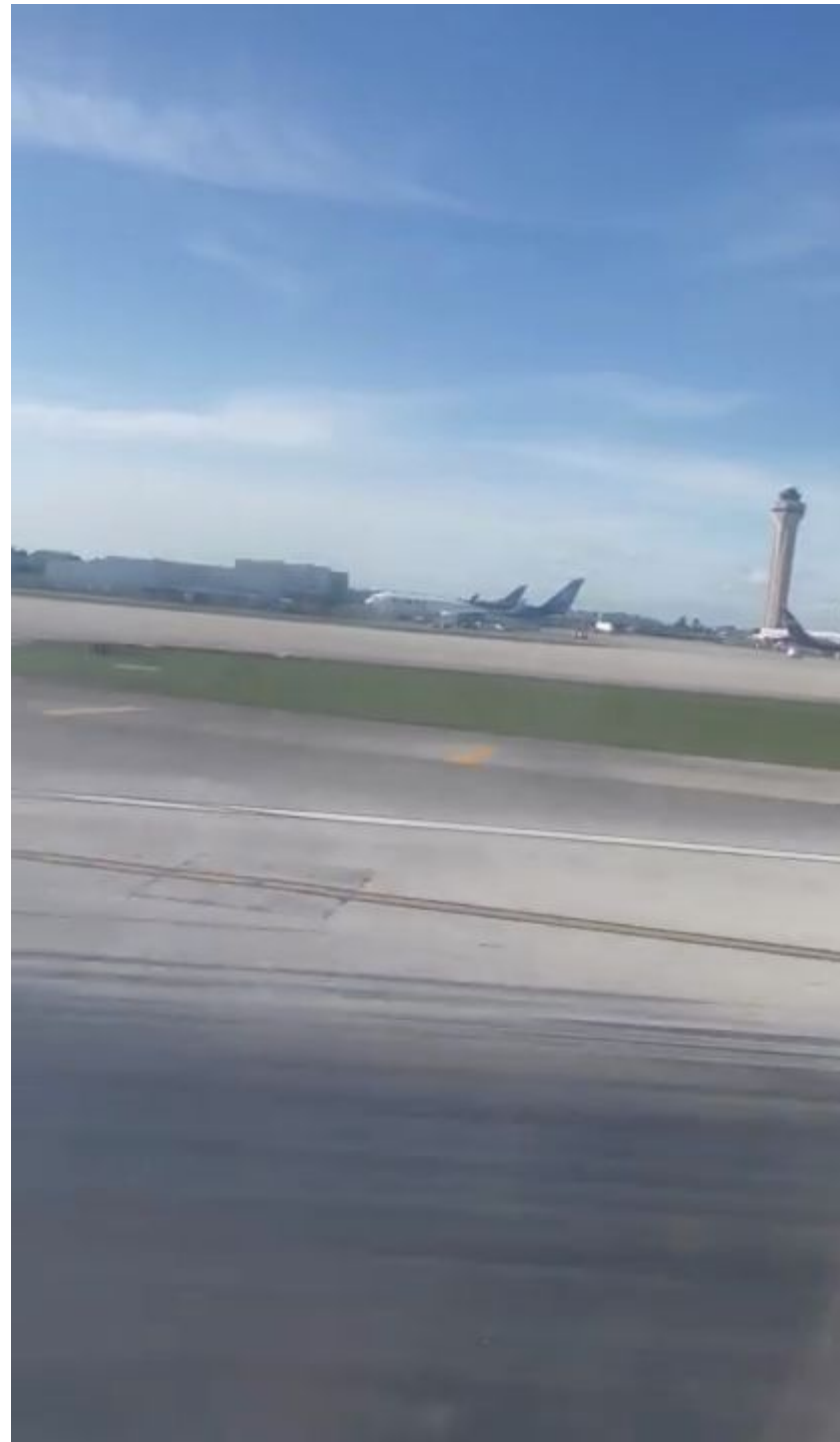



00244



00245

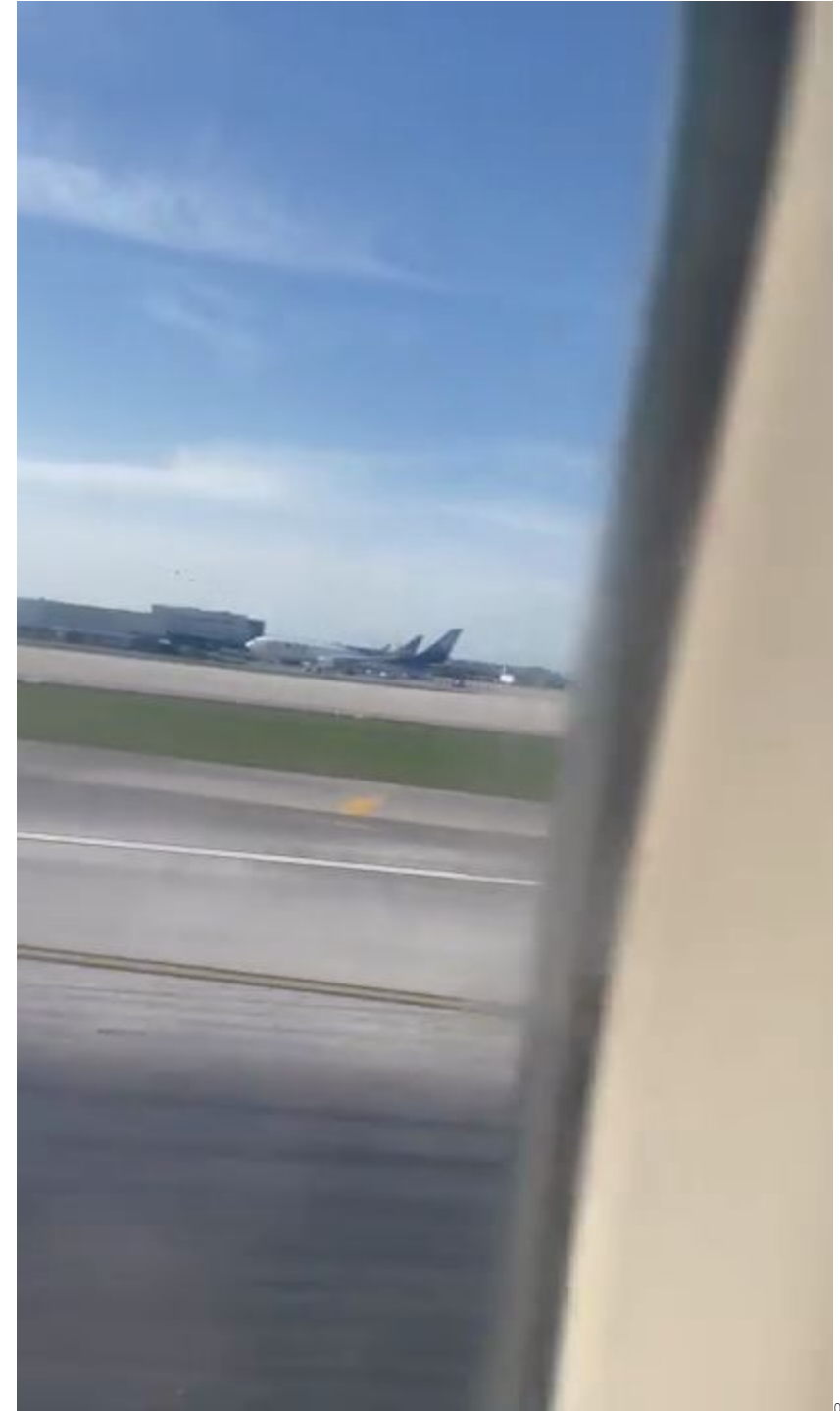

00246



00247



00248

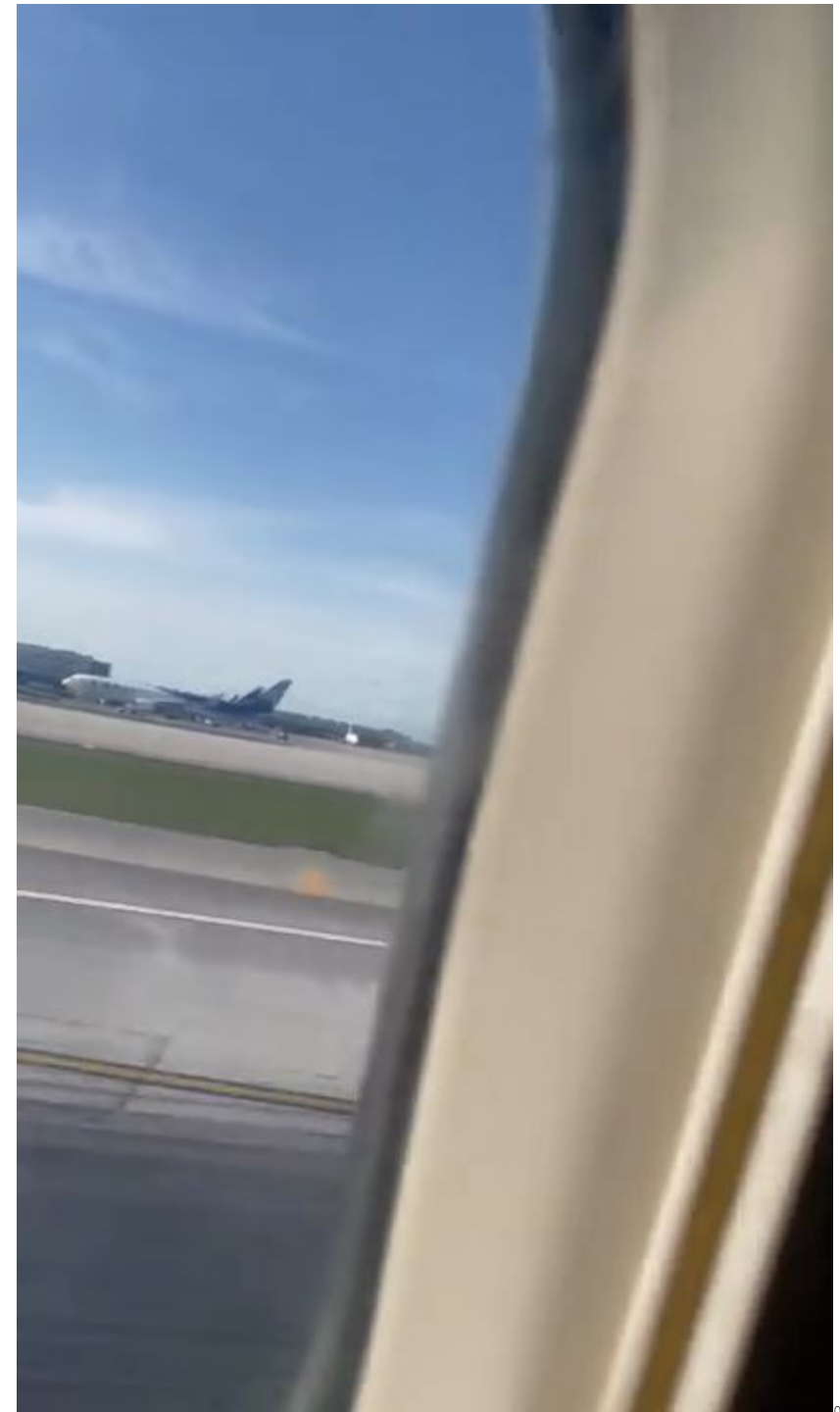

00249



00250

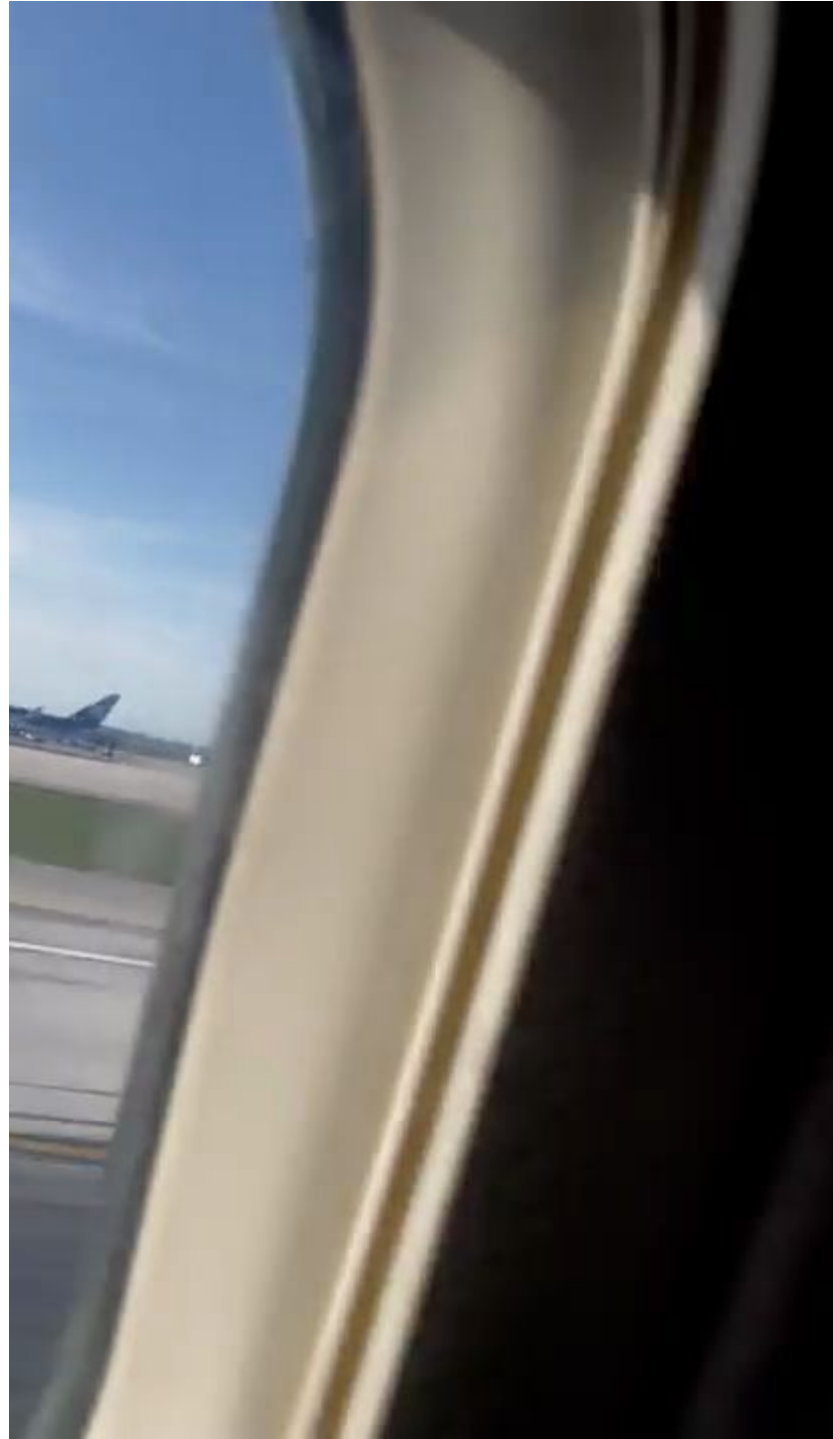

00251

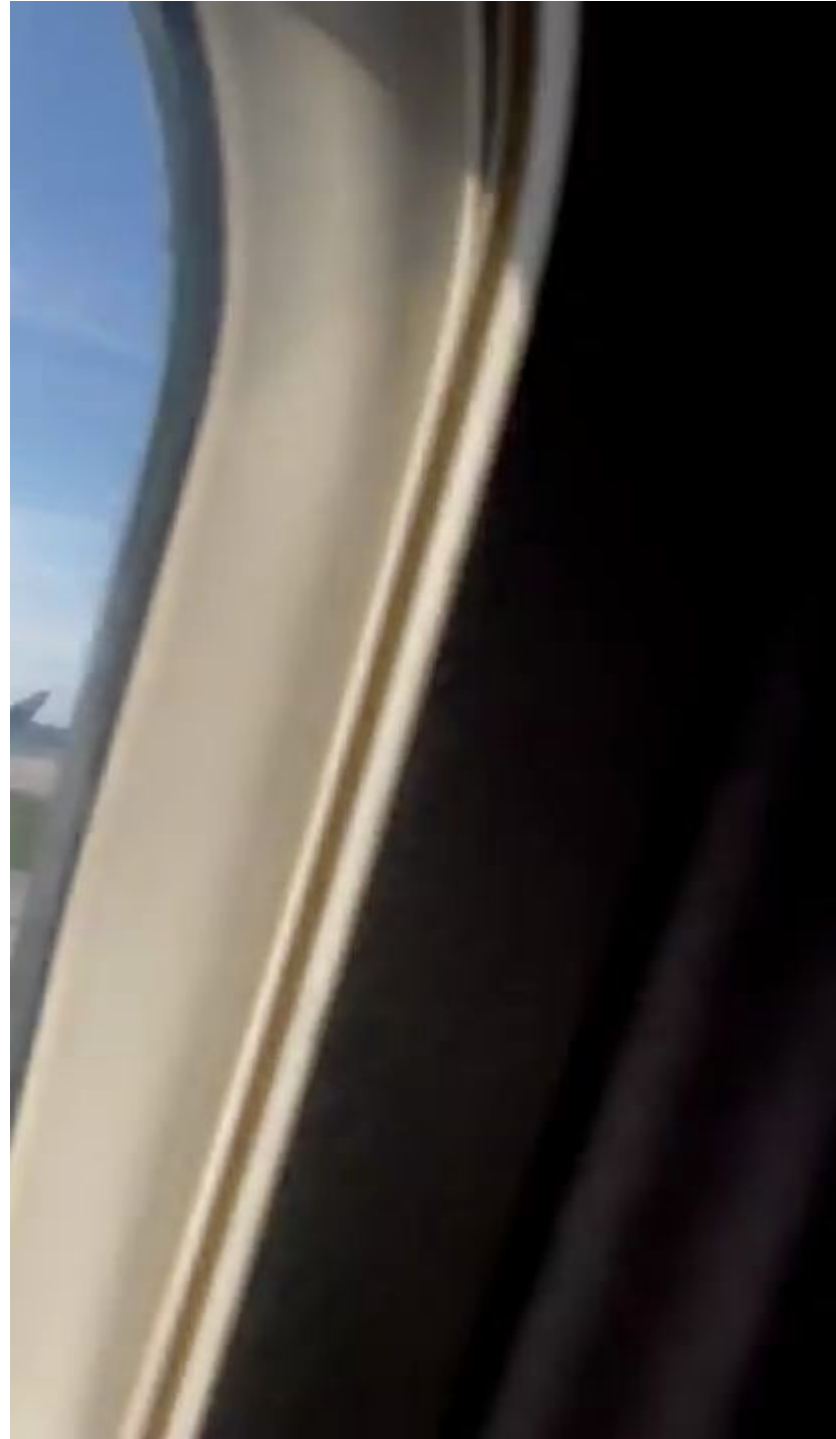

00252

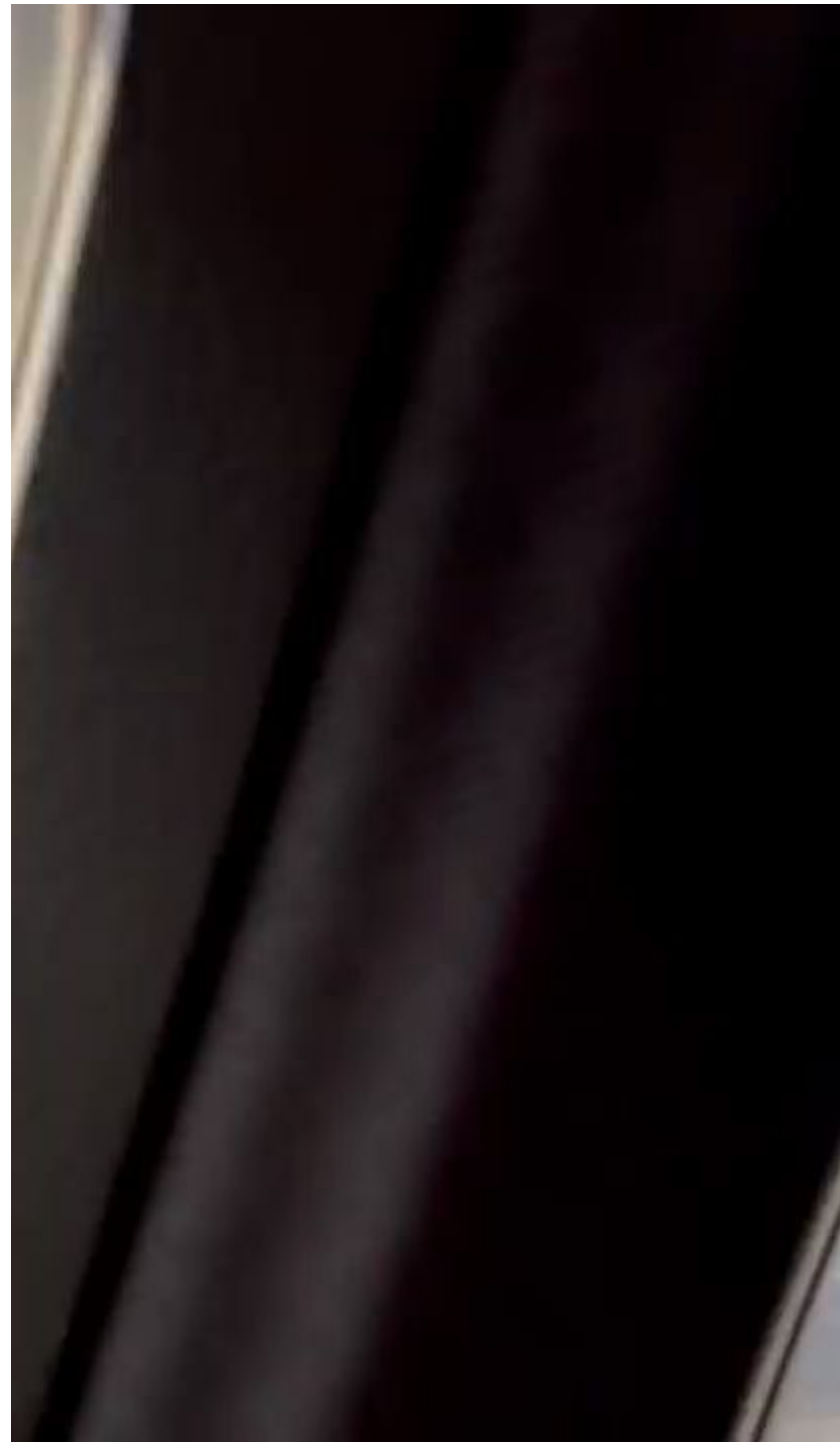

00253

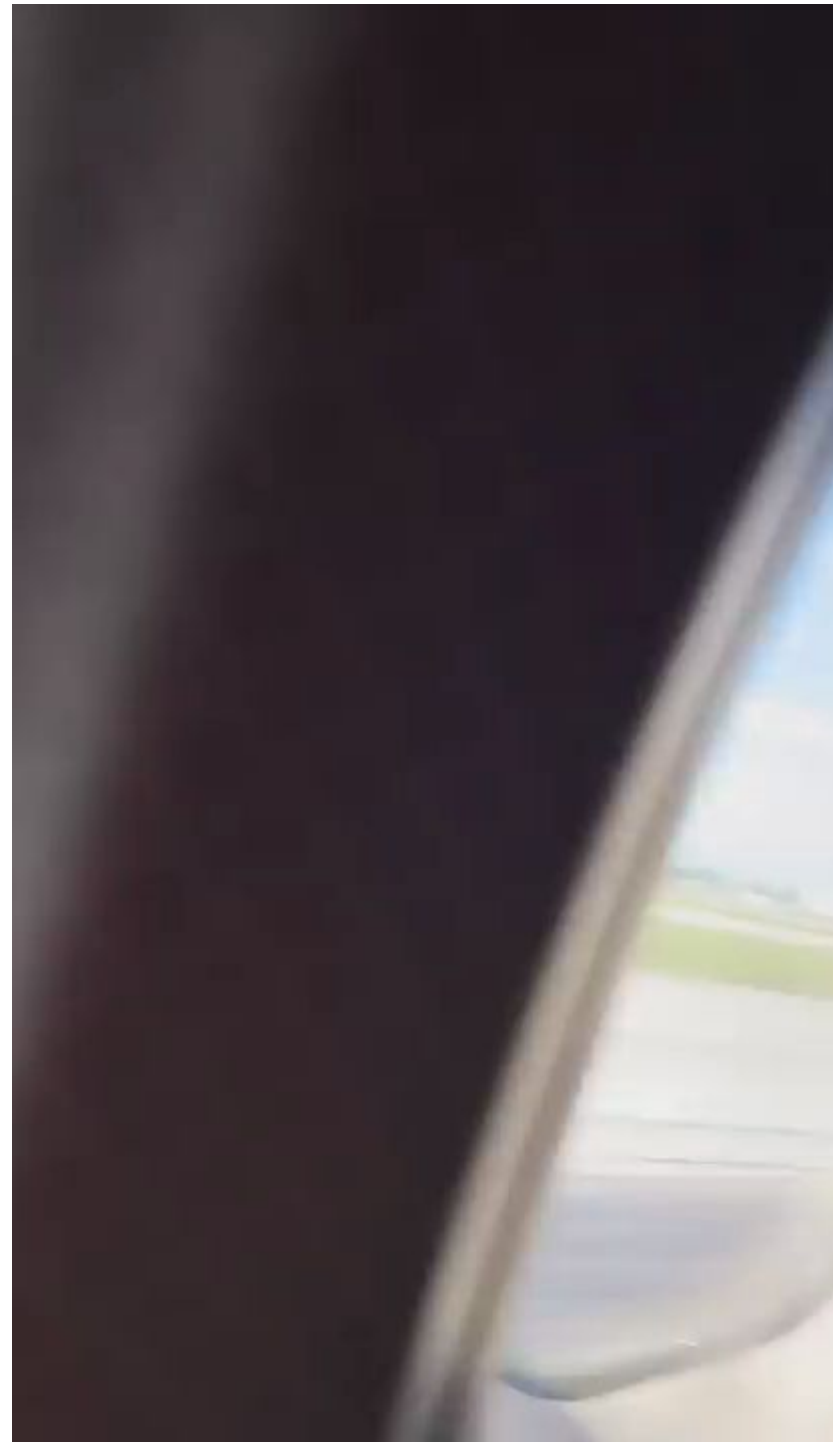

00254

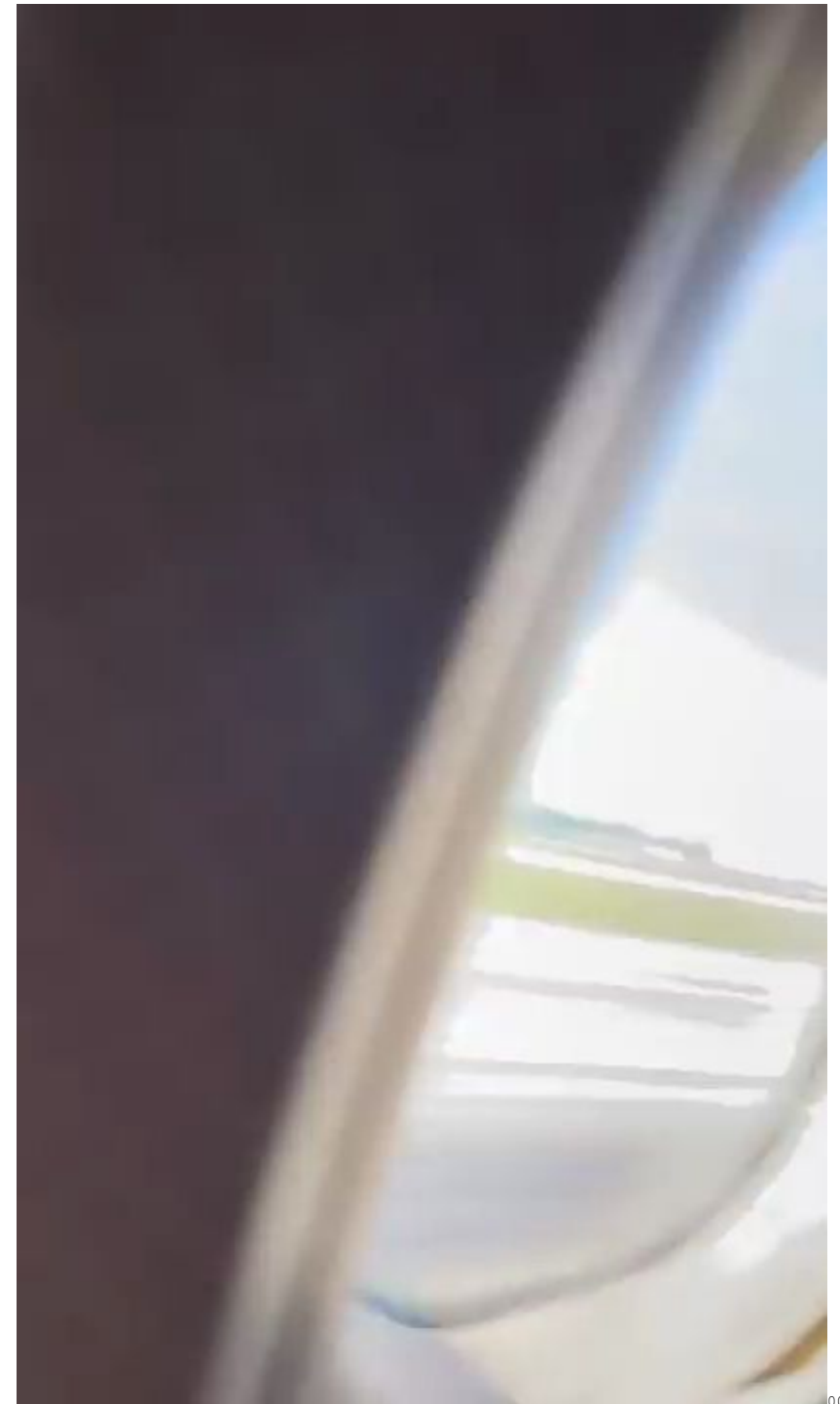

00255

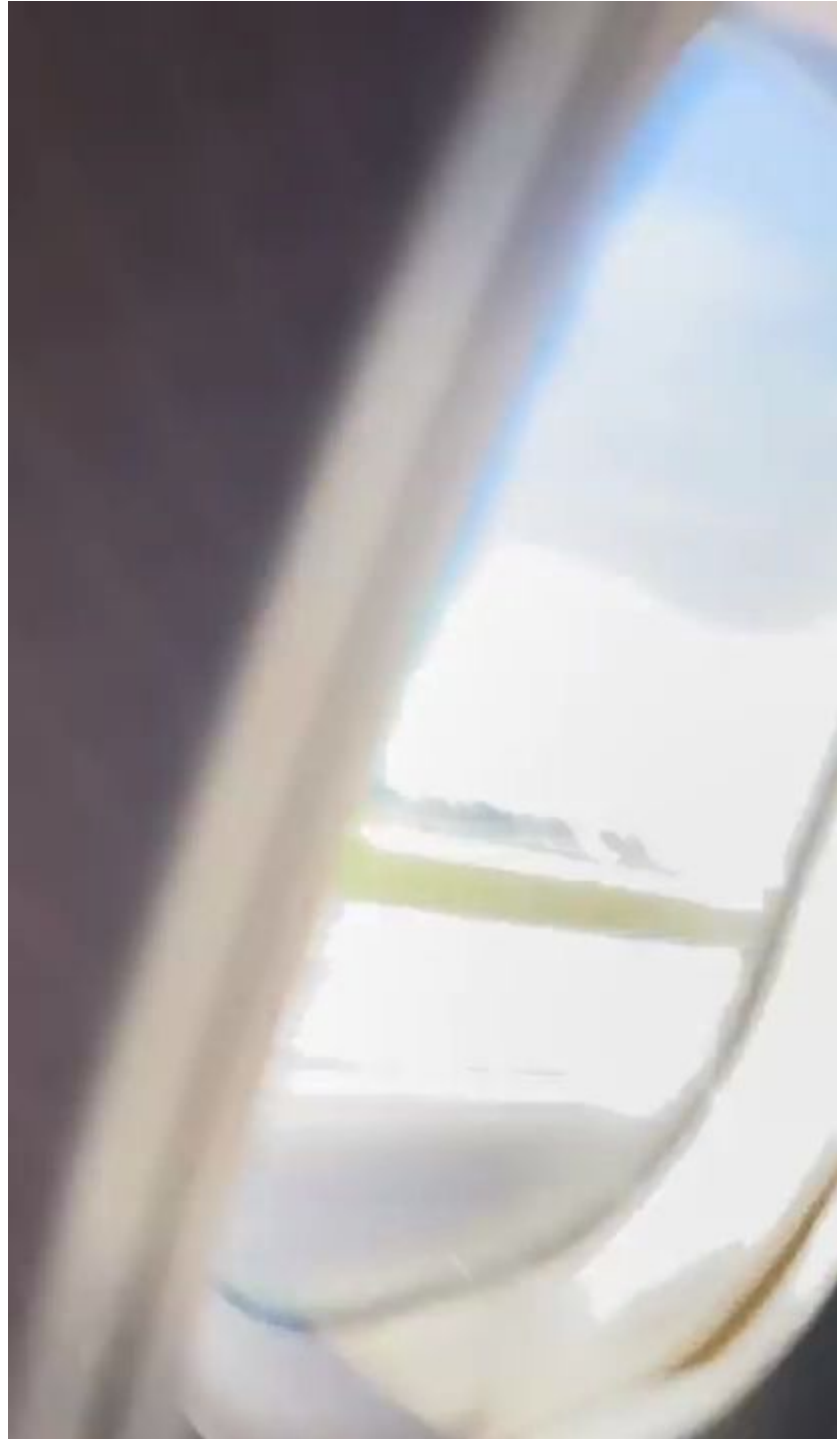

00256



00257

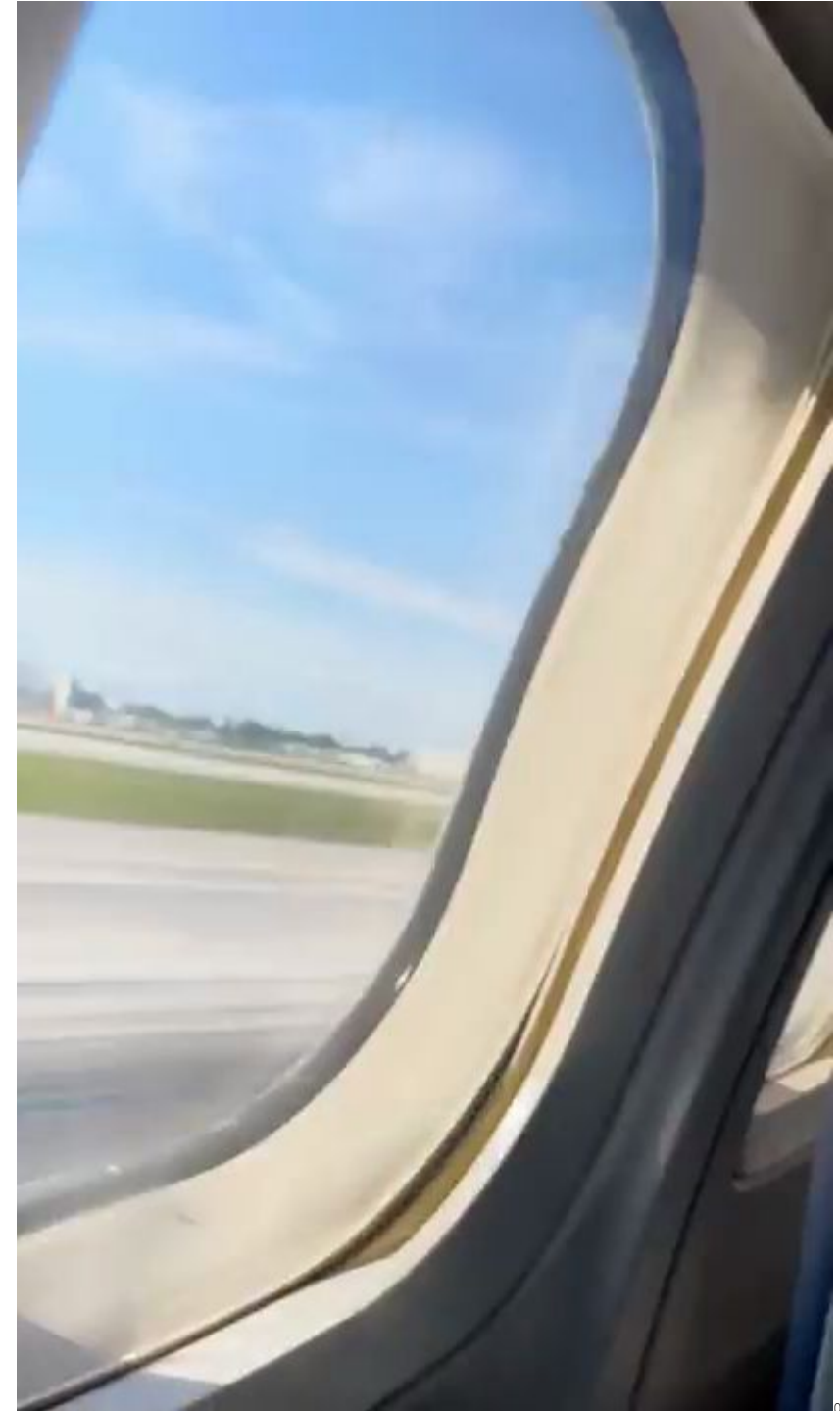

00258

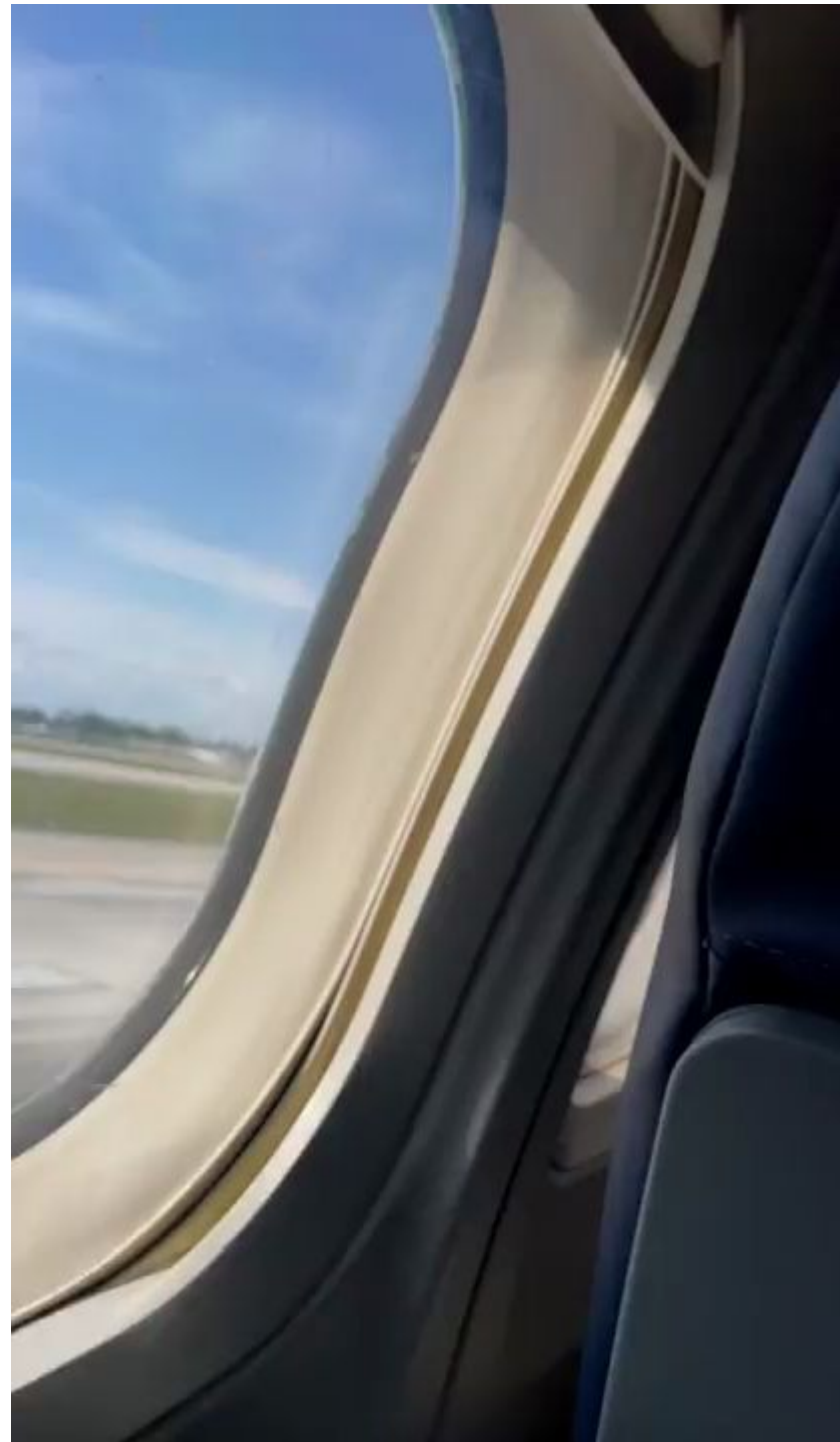

00259

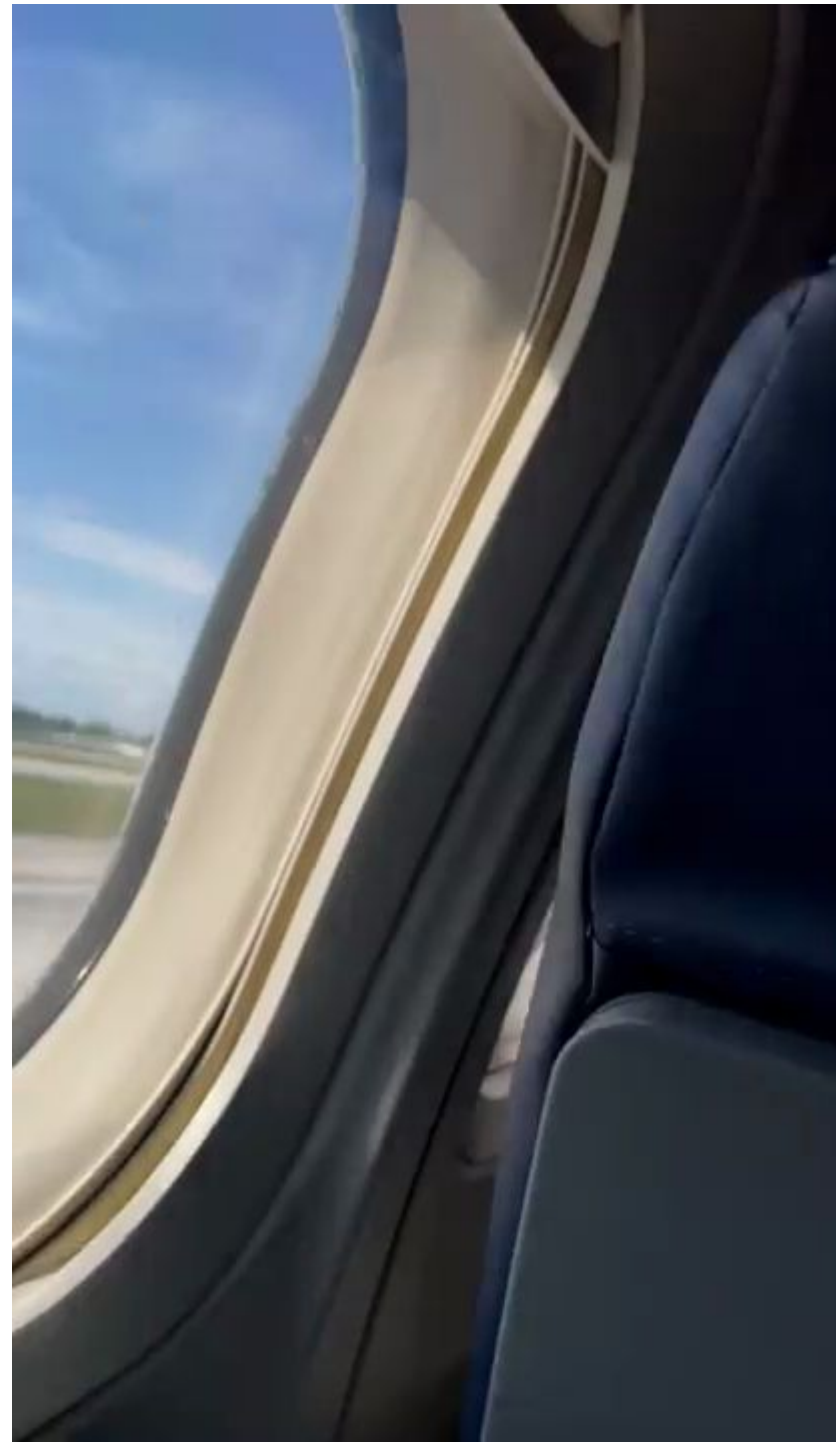

00260



00261

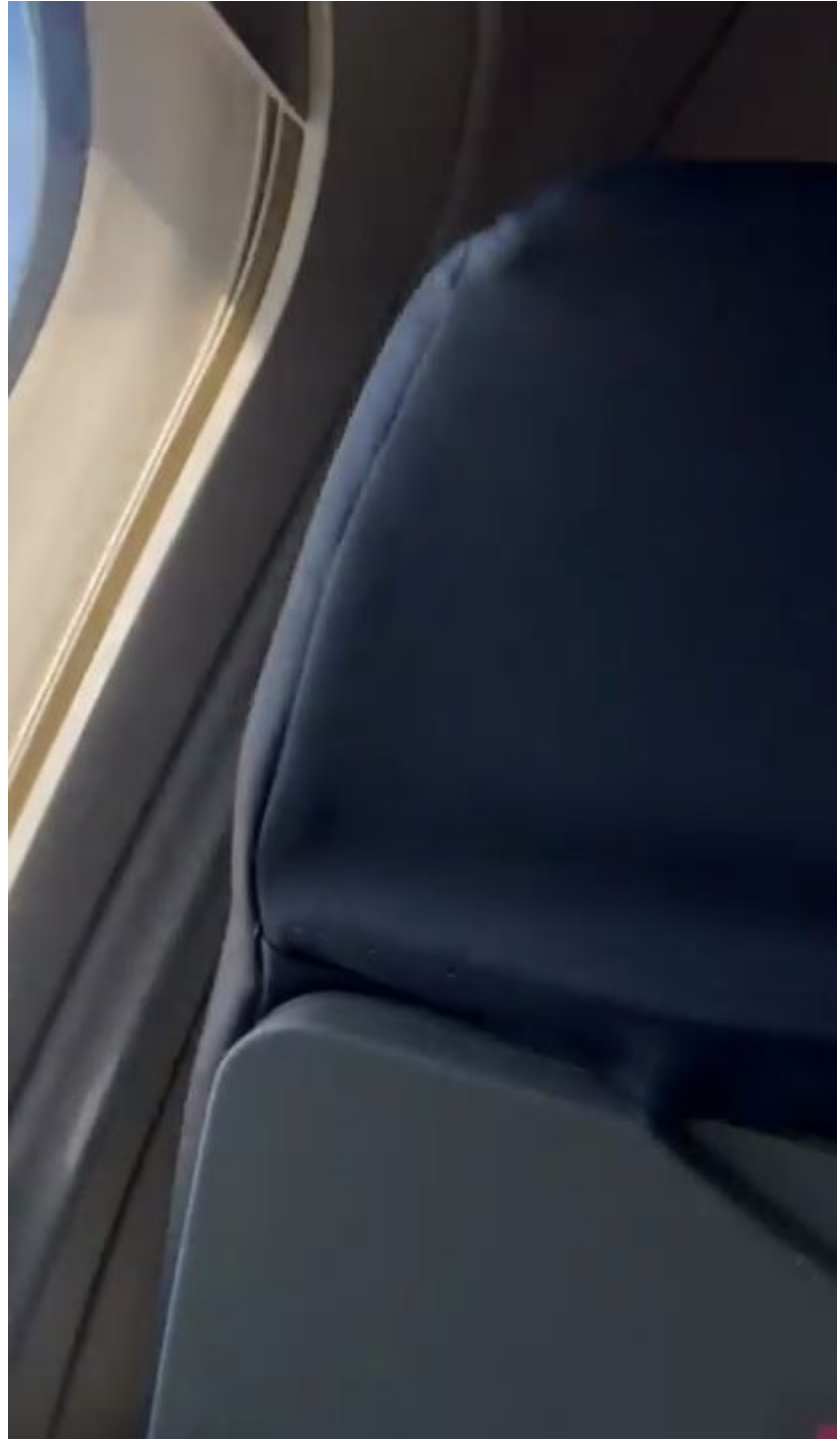

00262

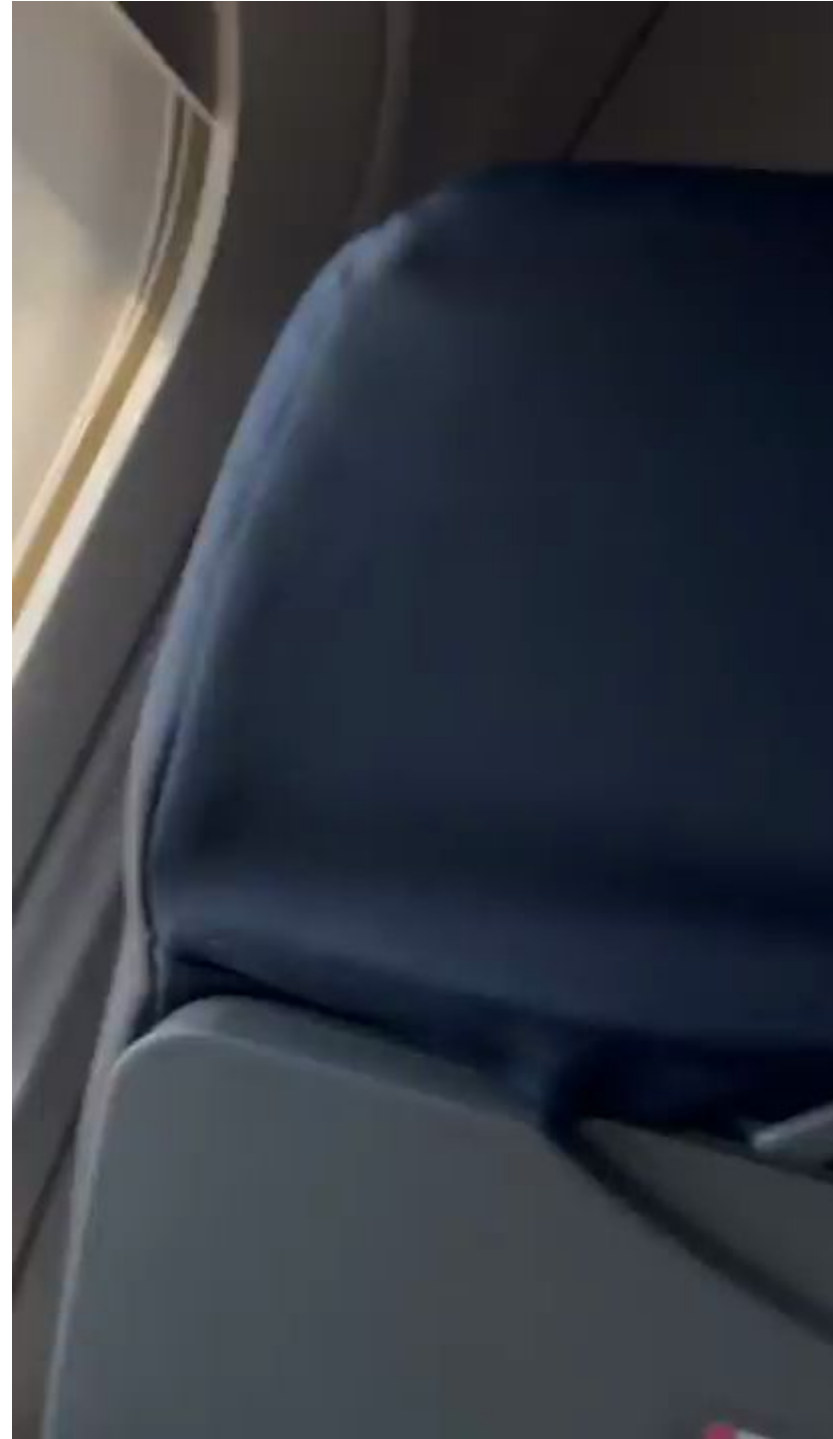

00263

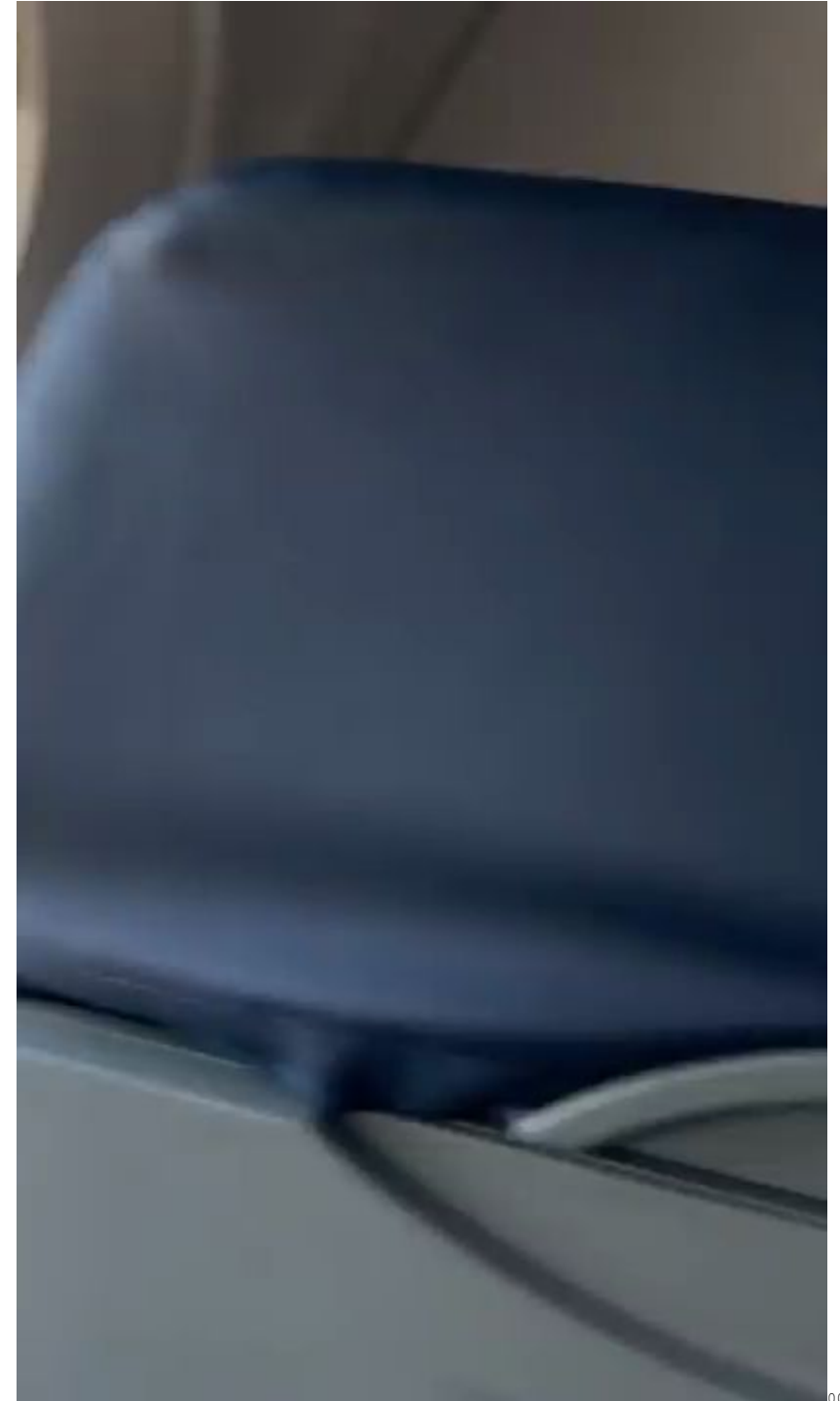

00264

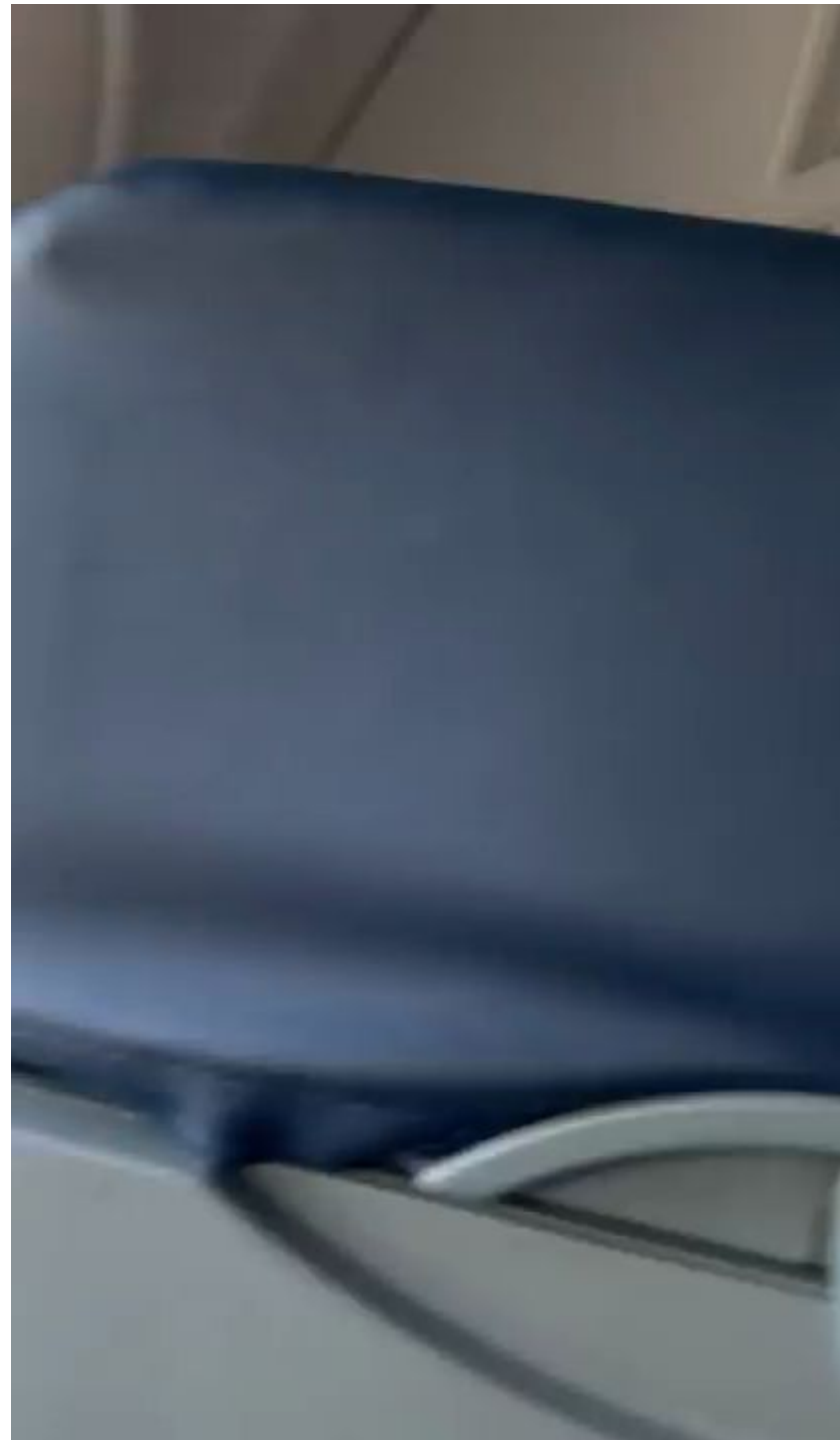

00265

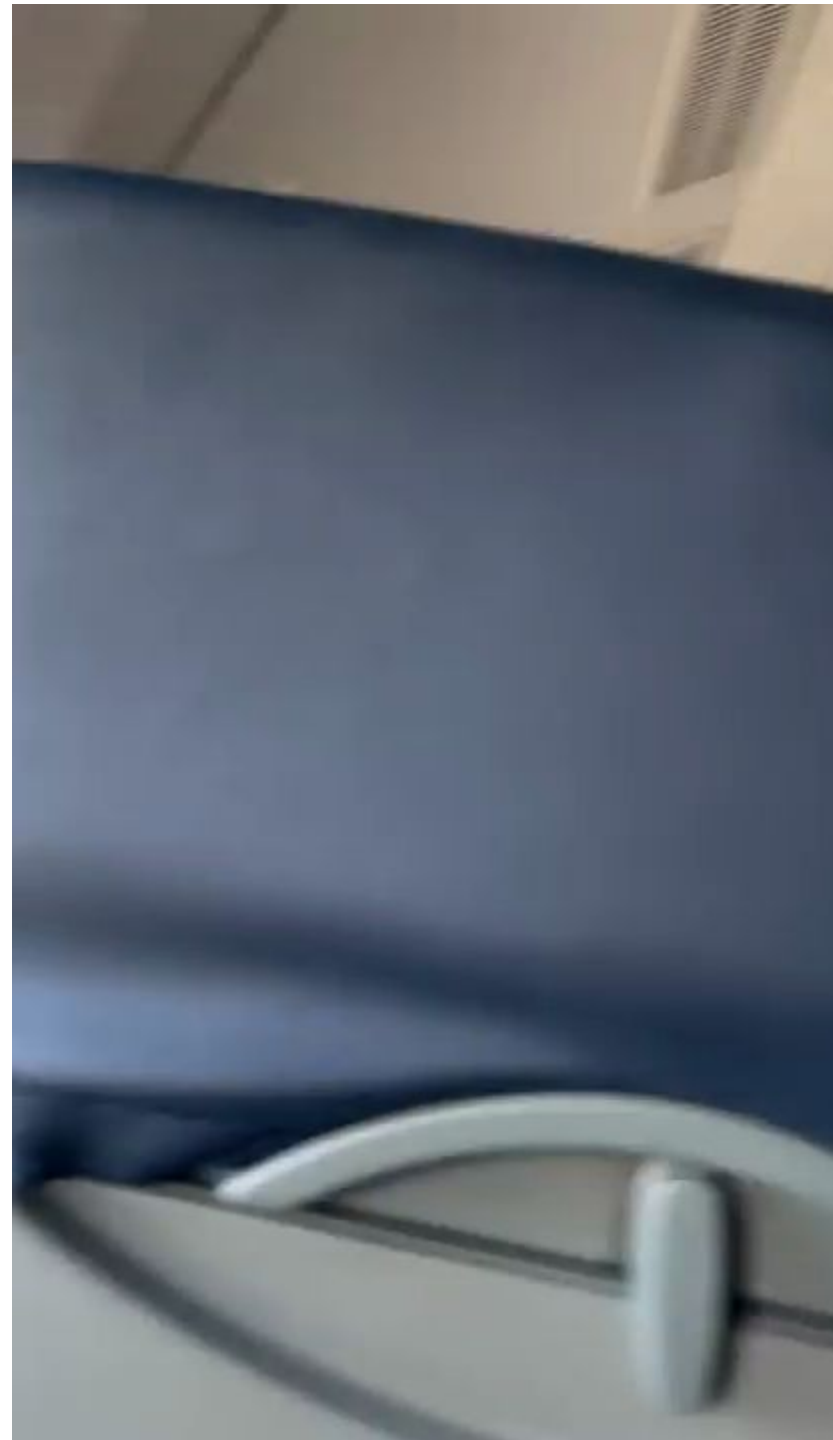

00266

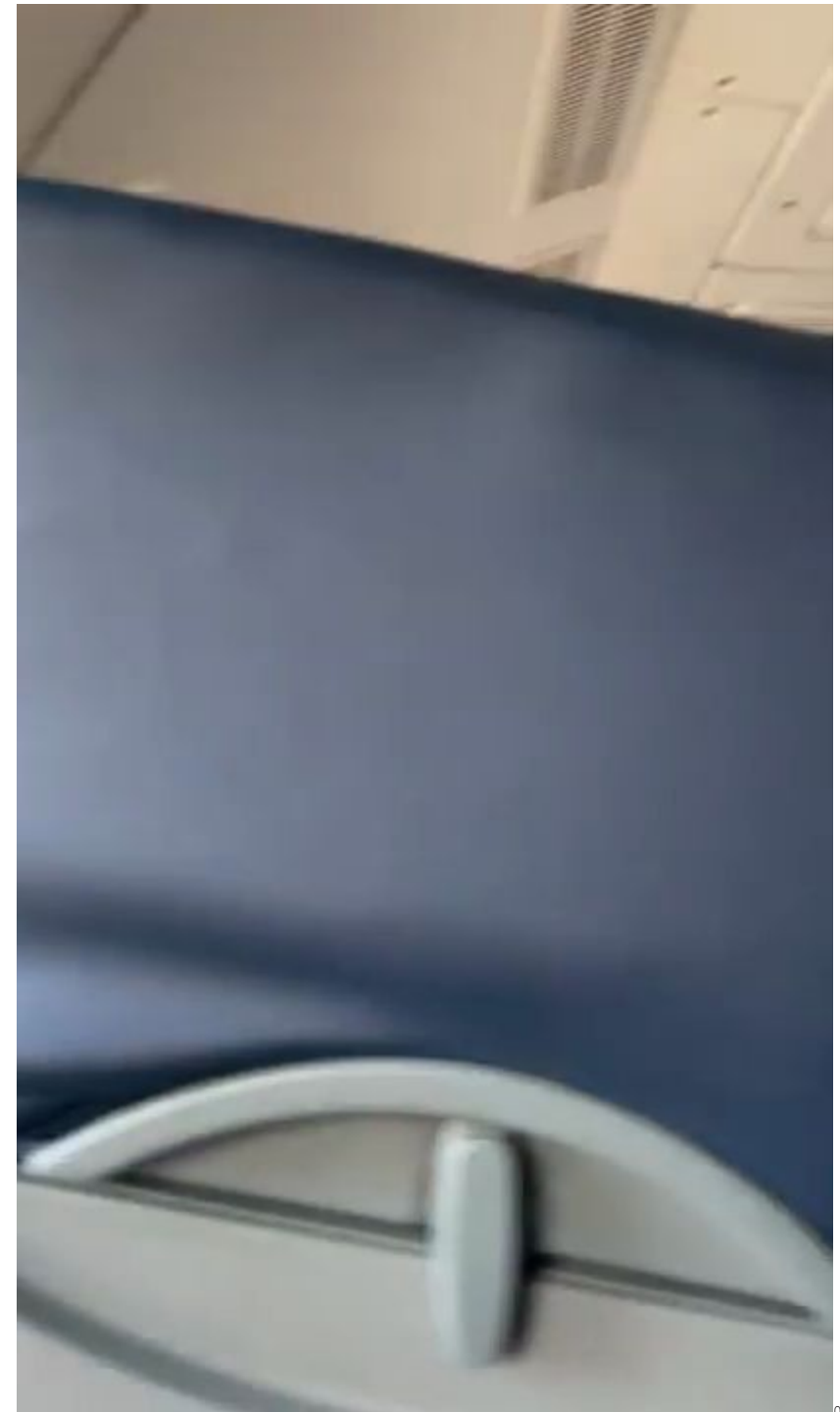

00267

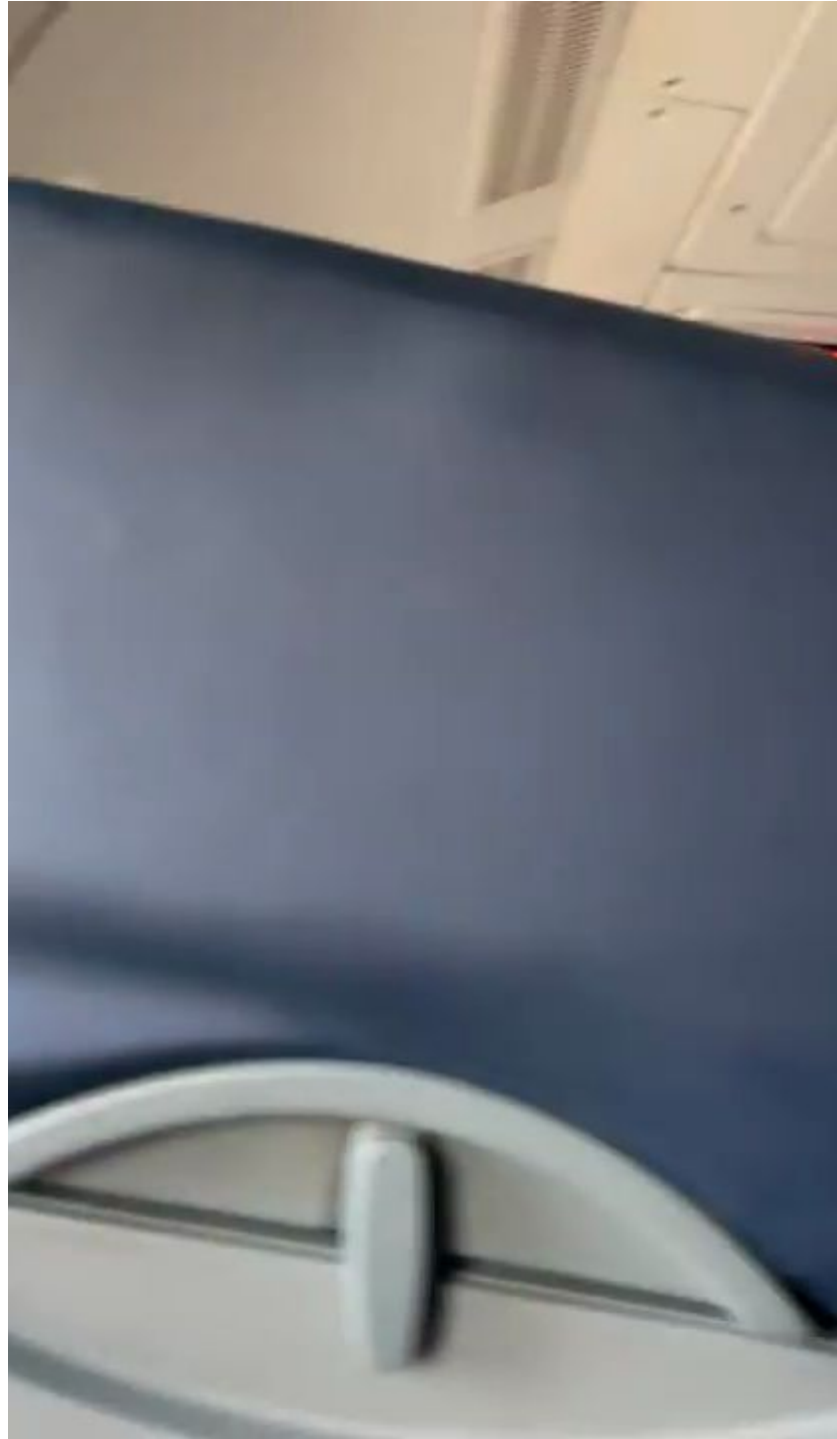

00268

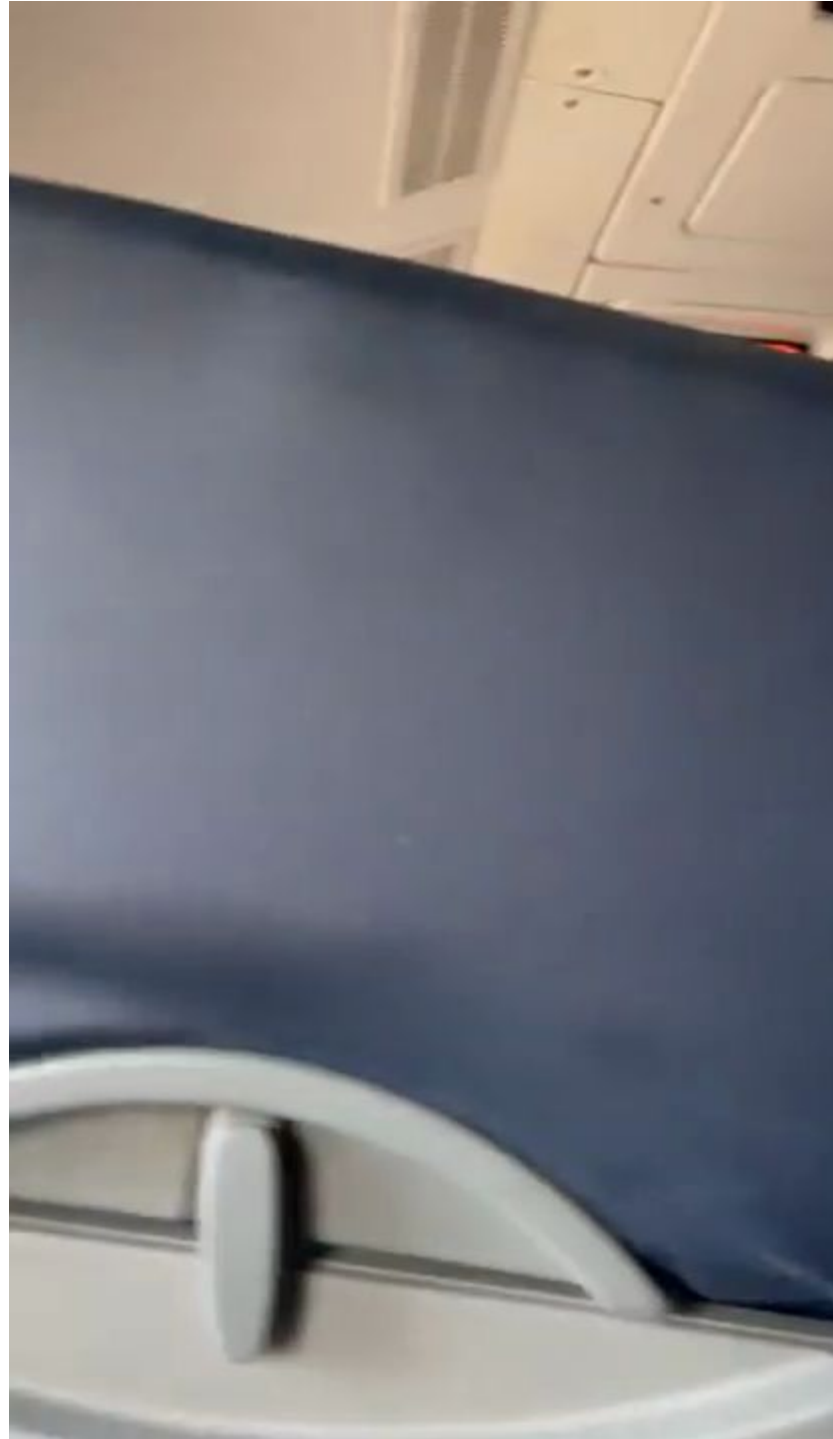

00269

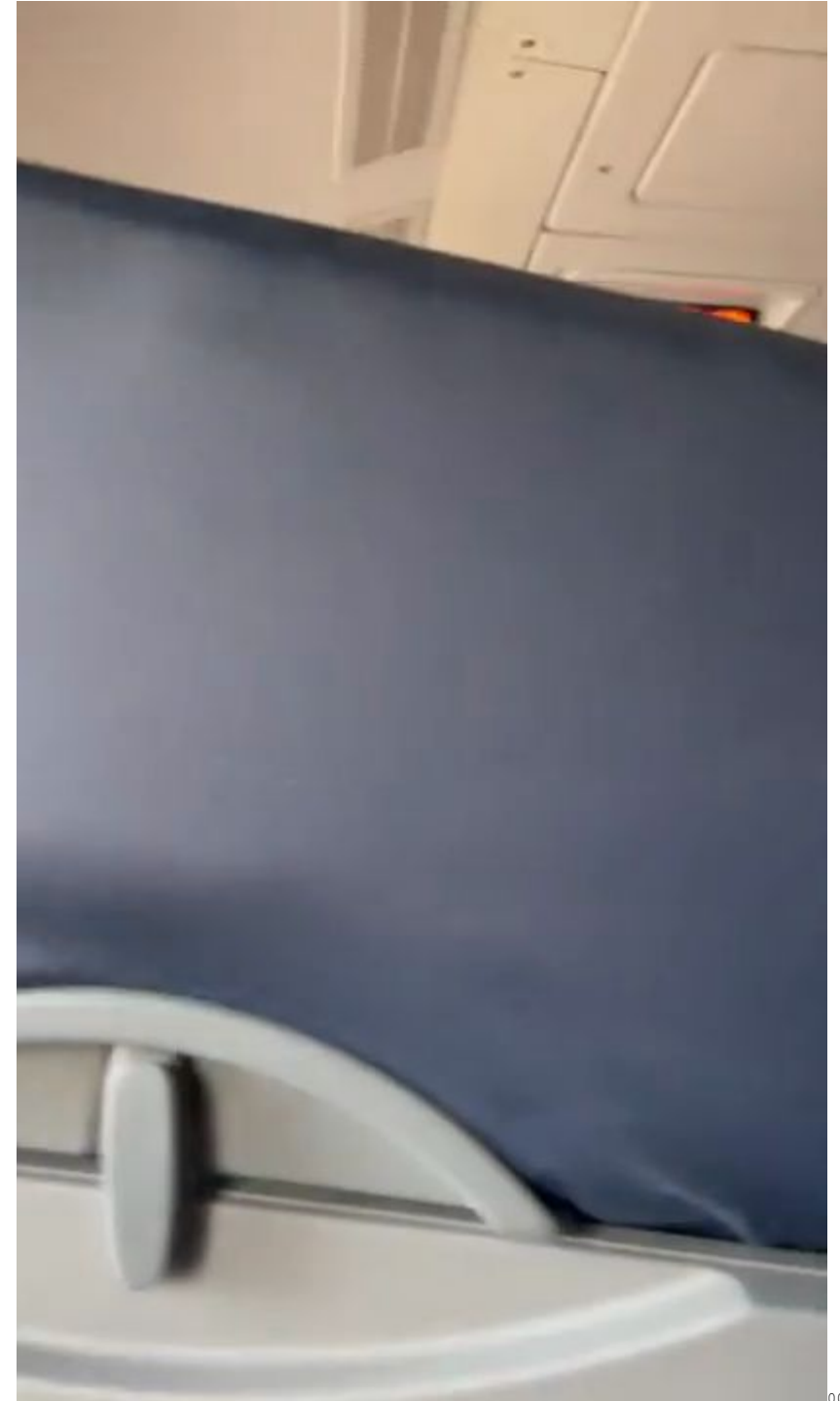

00270

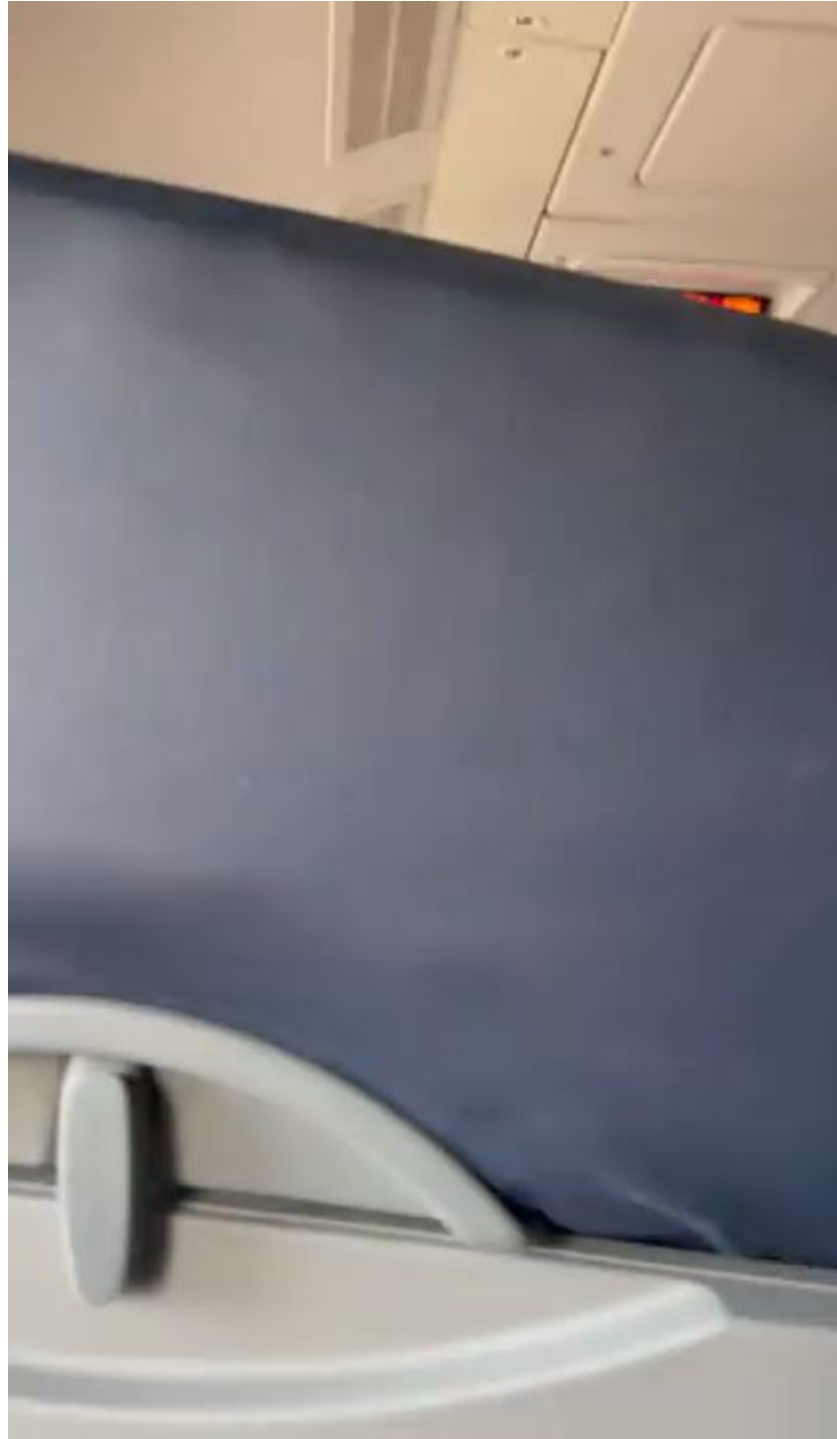

00271

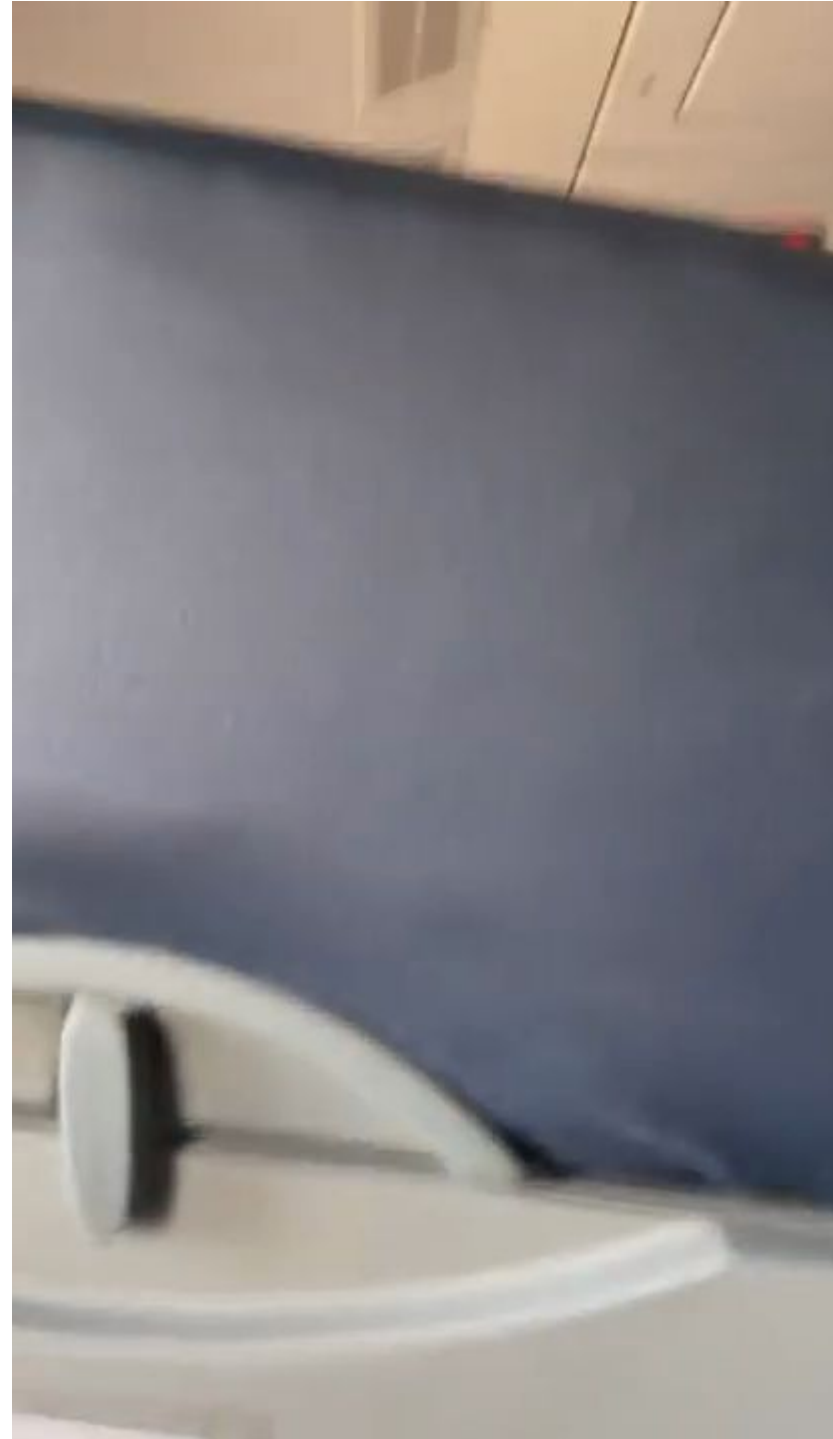

00272

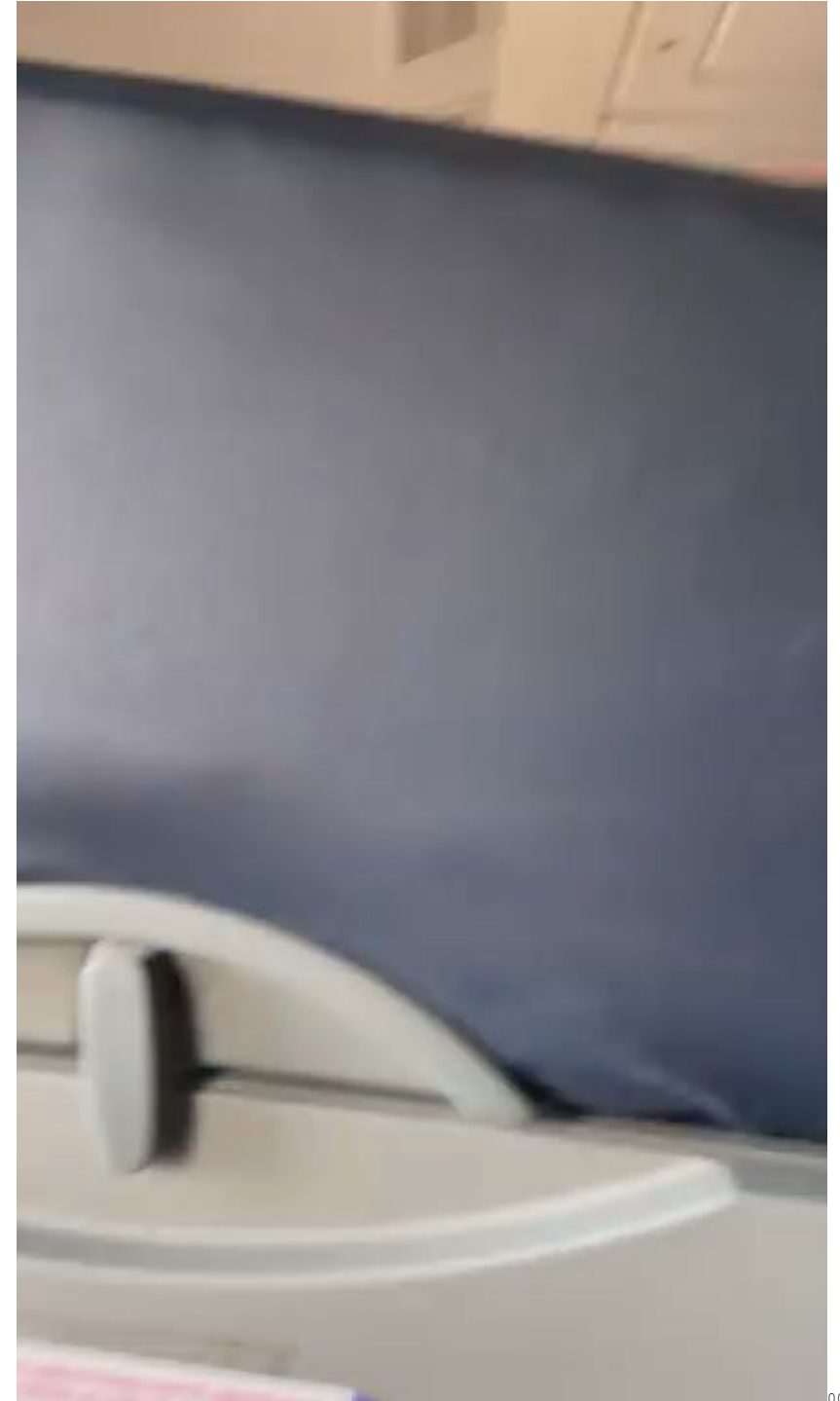

00273

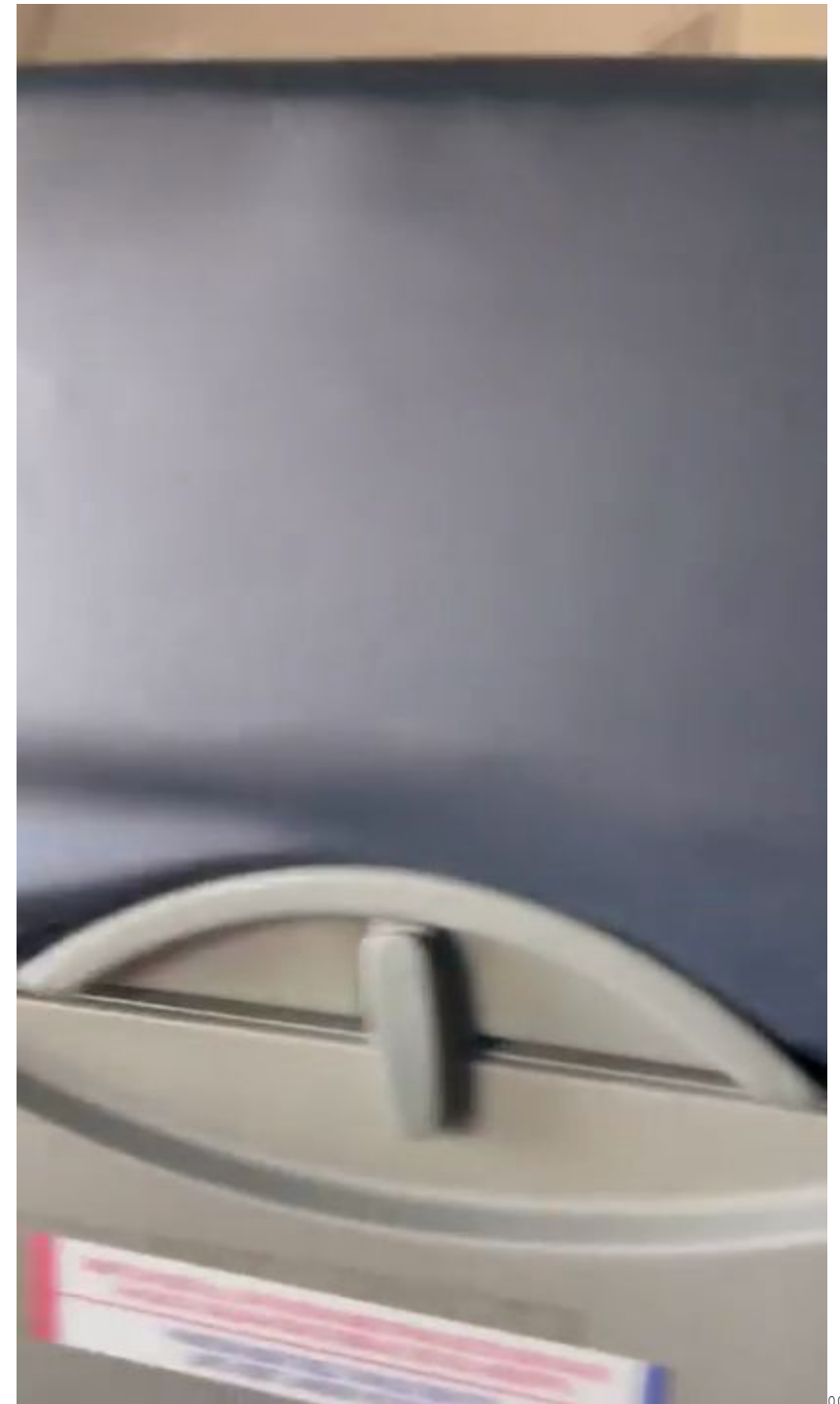
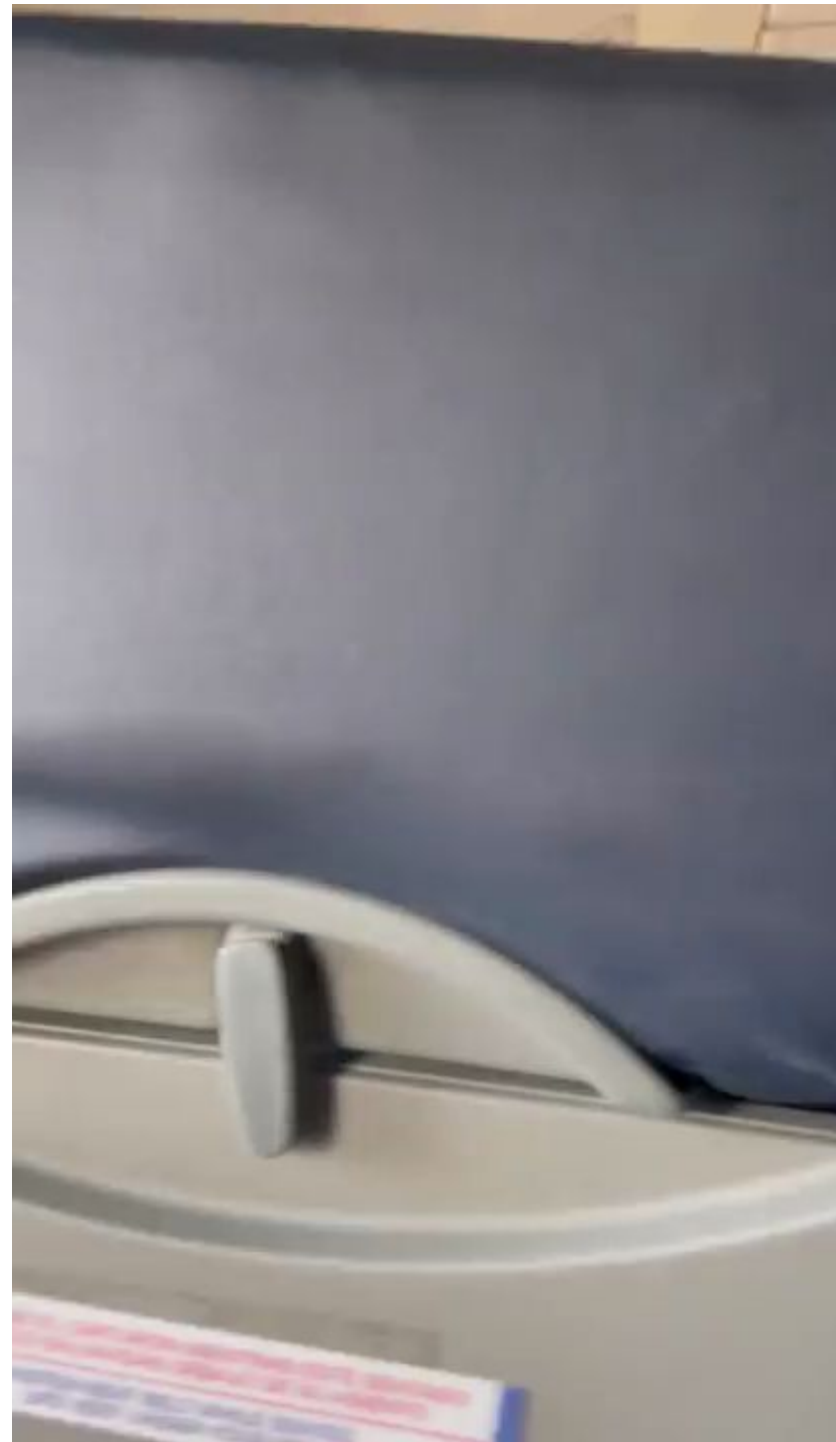
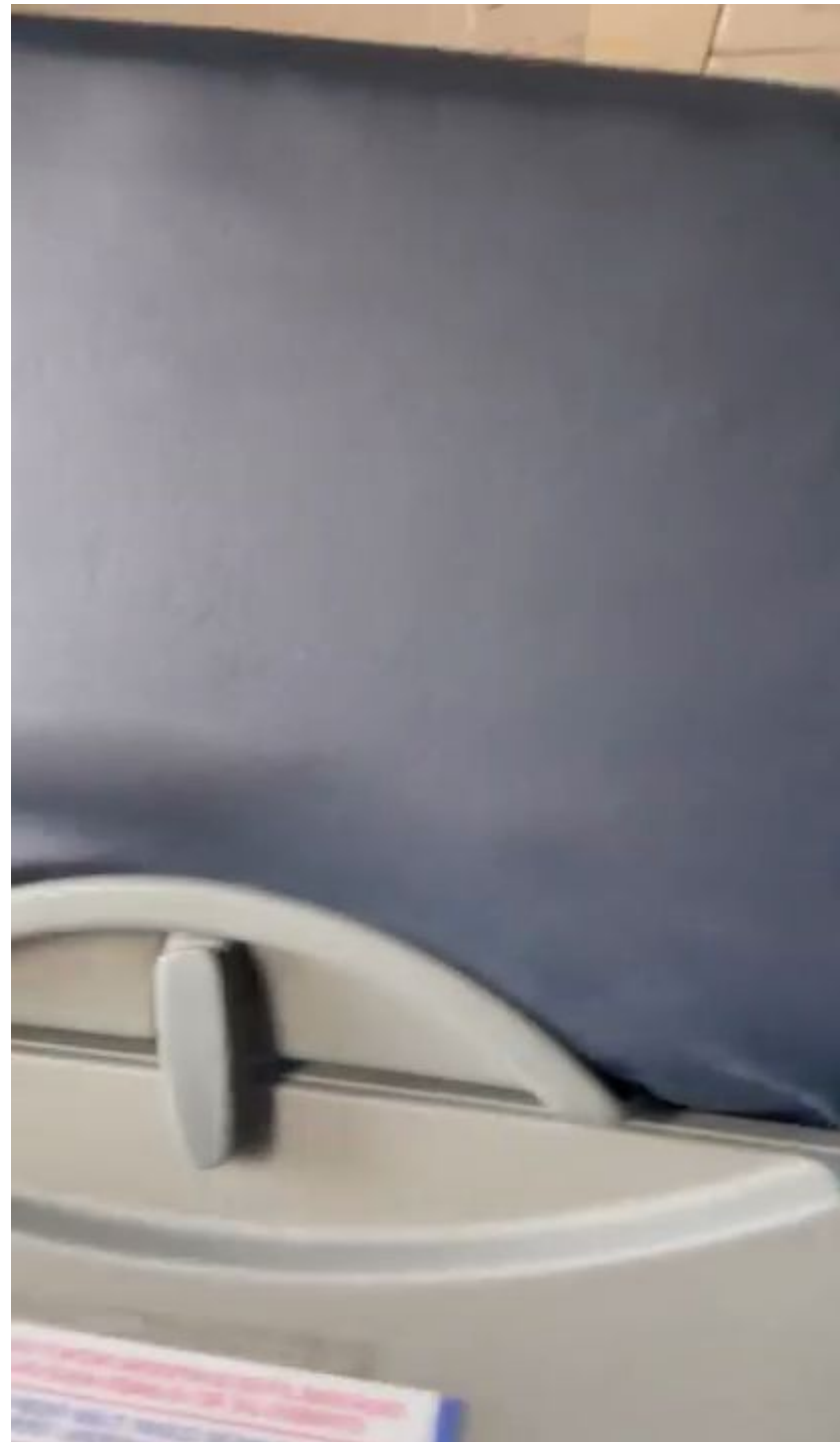

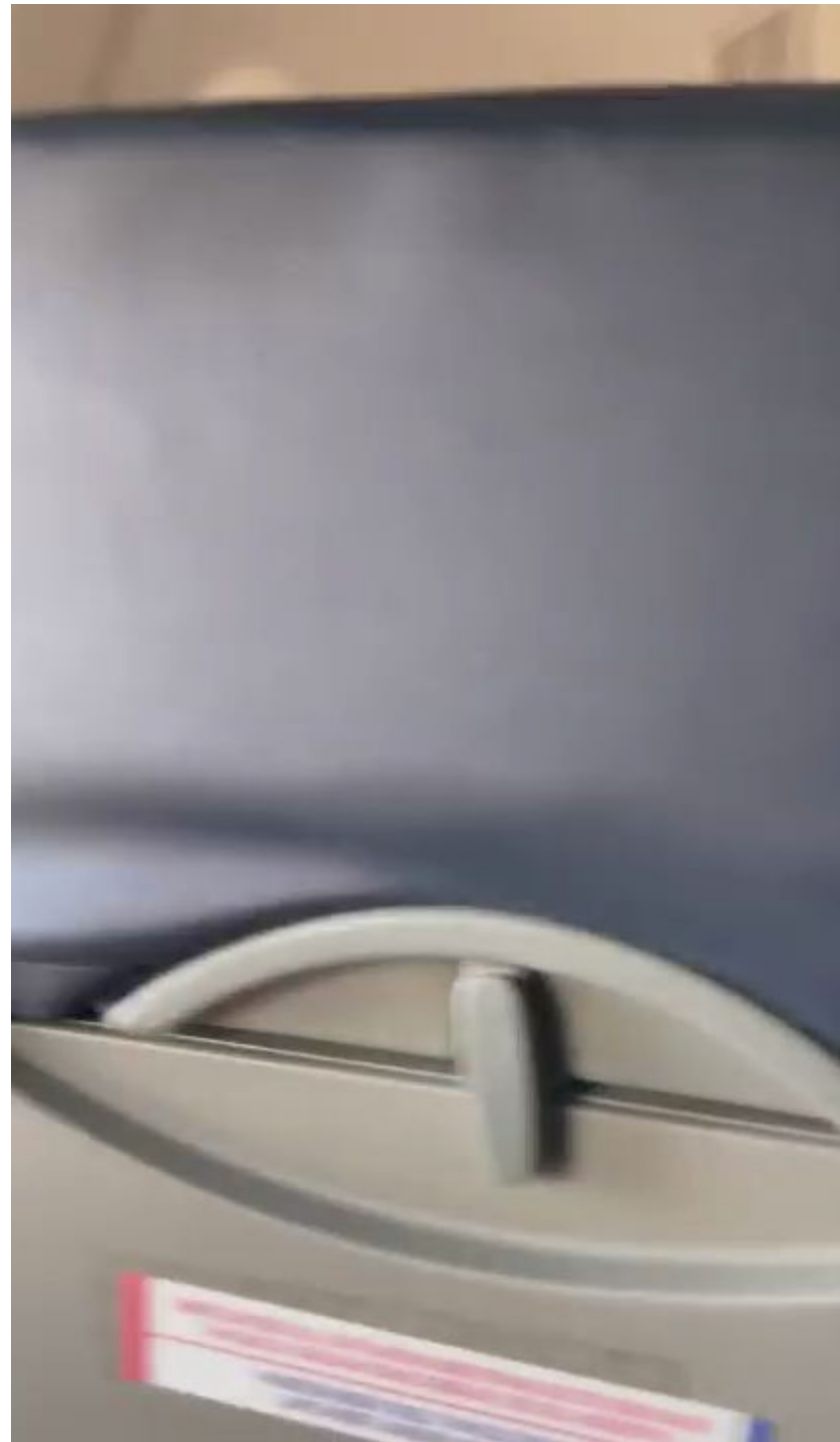

00277

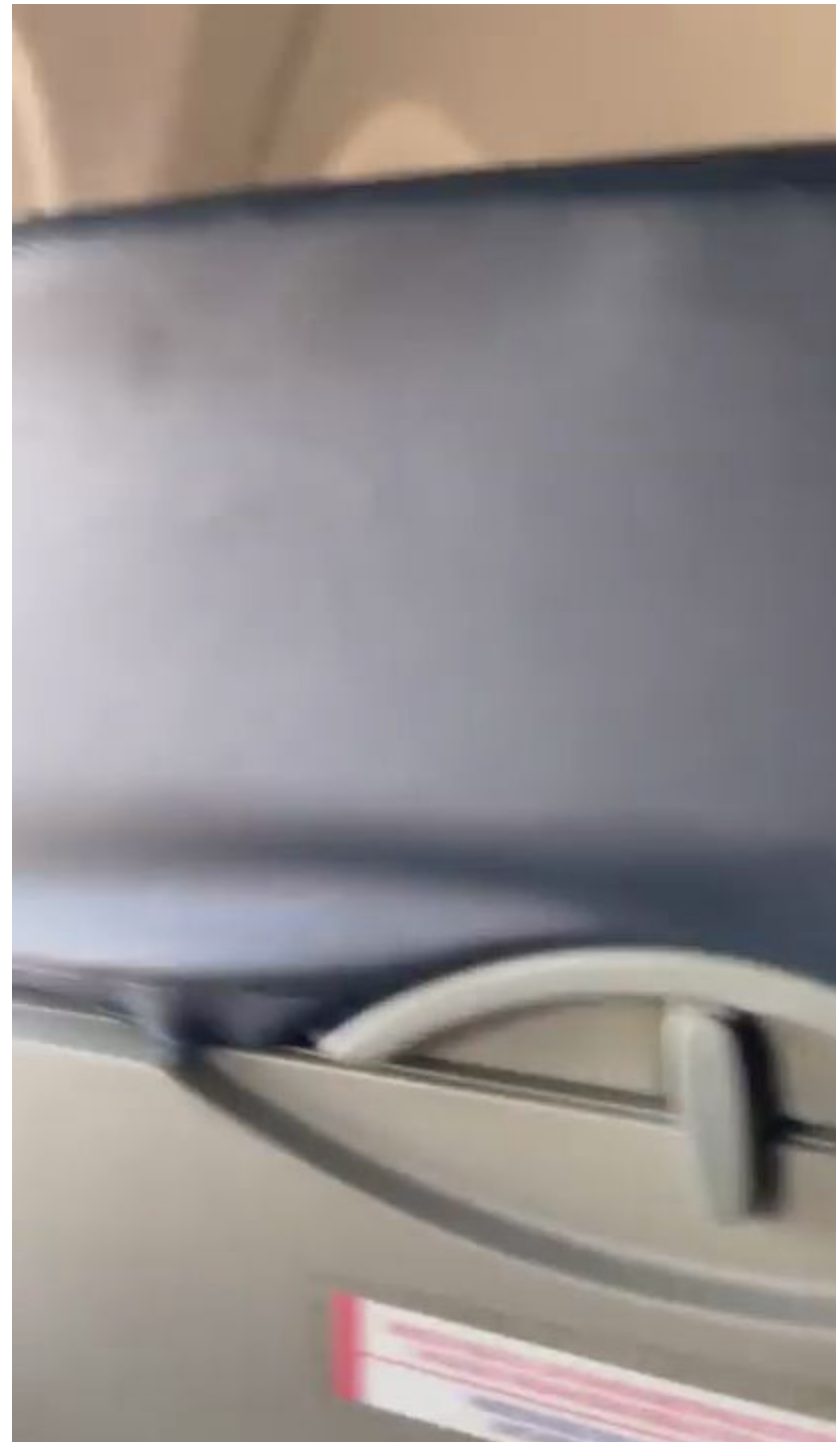

00278

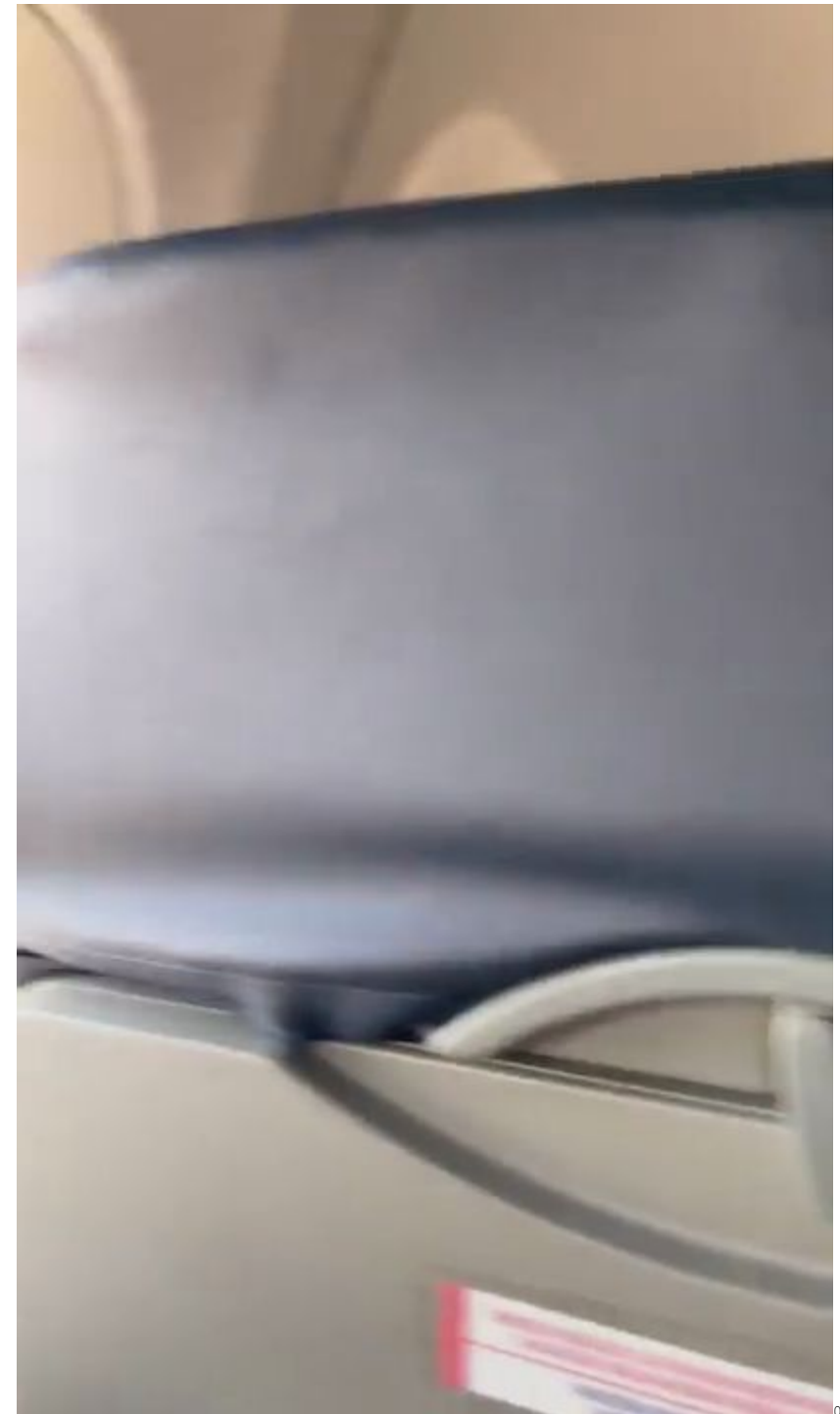

00279

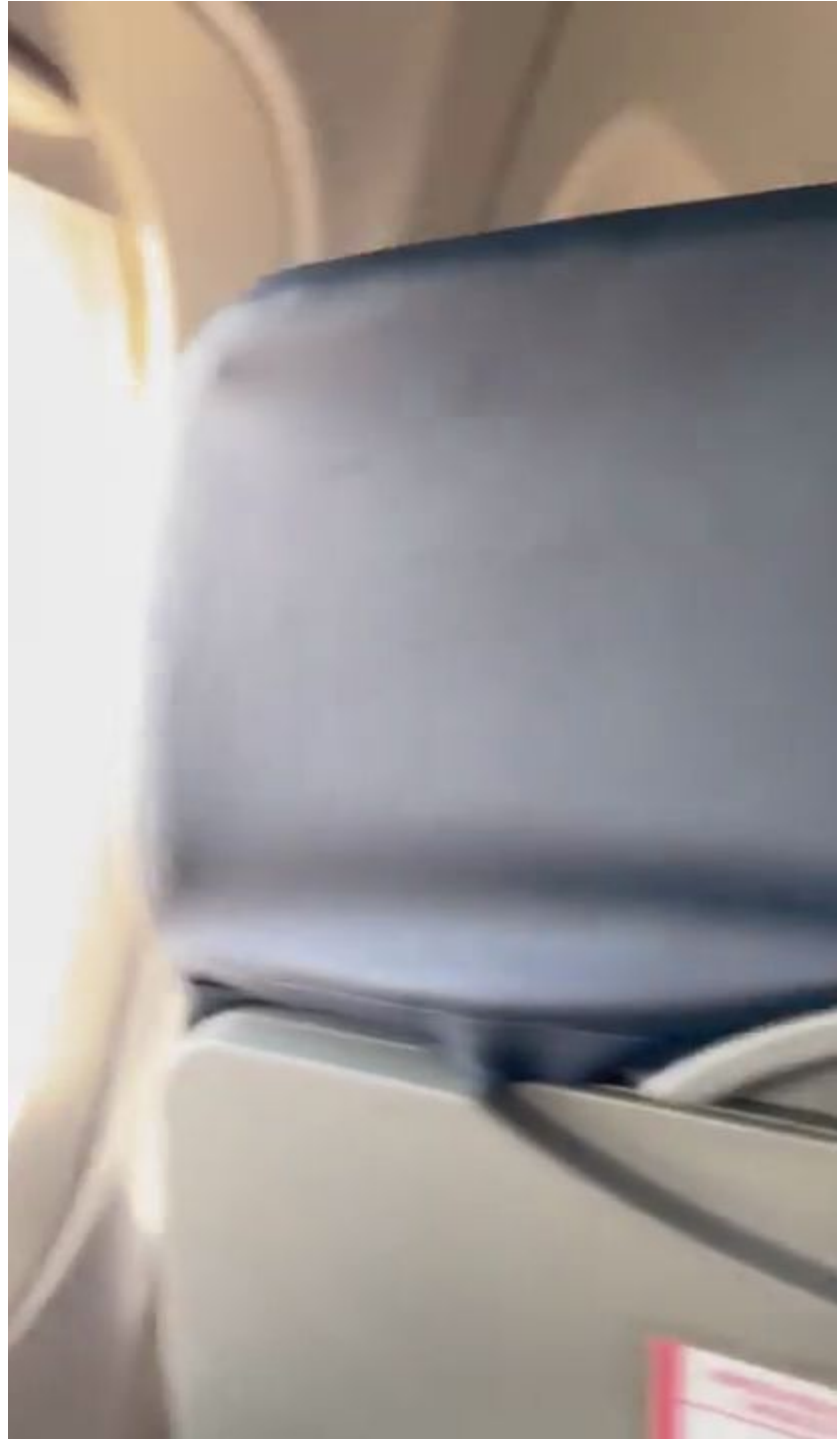

00280

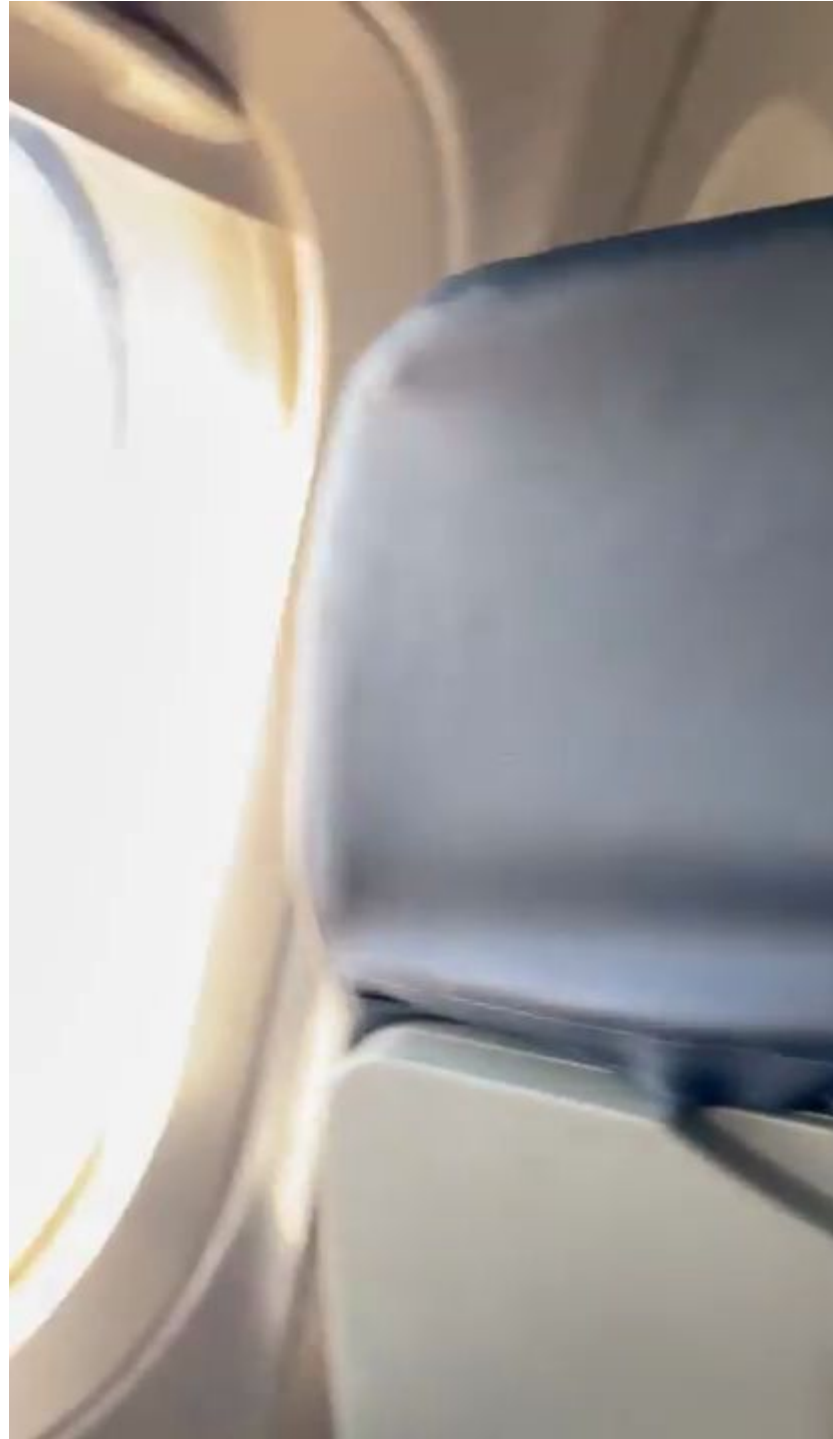

00281

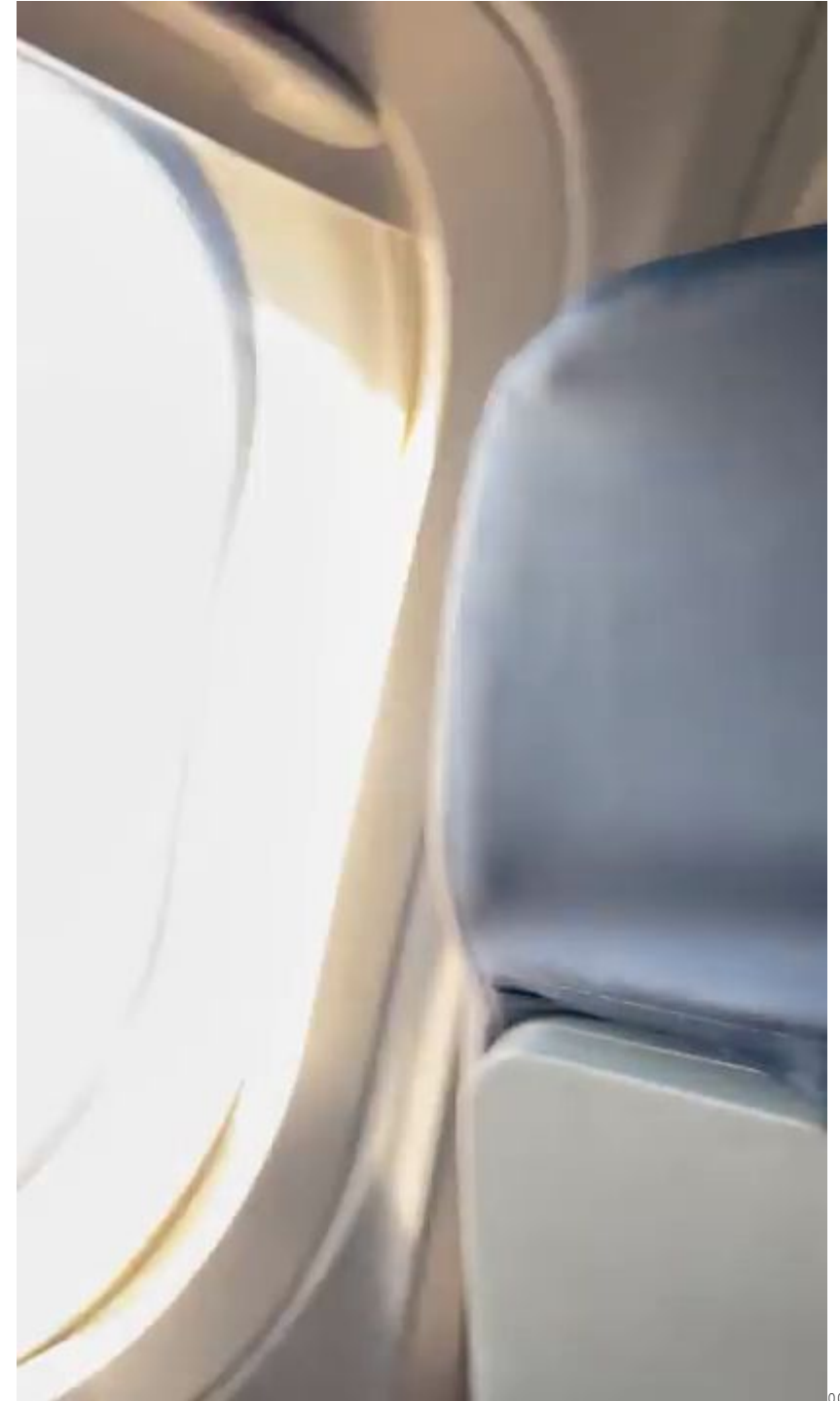

00282

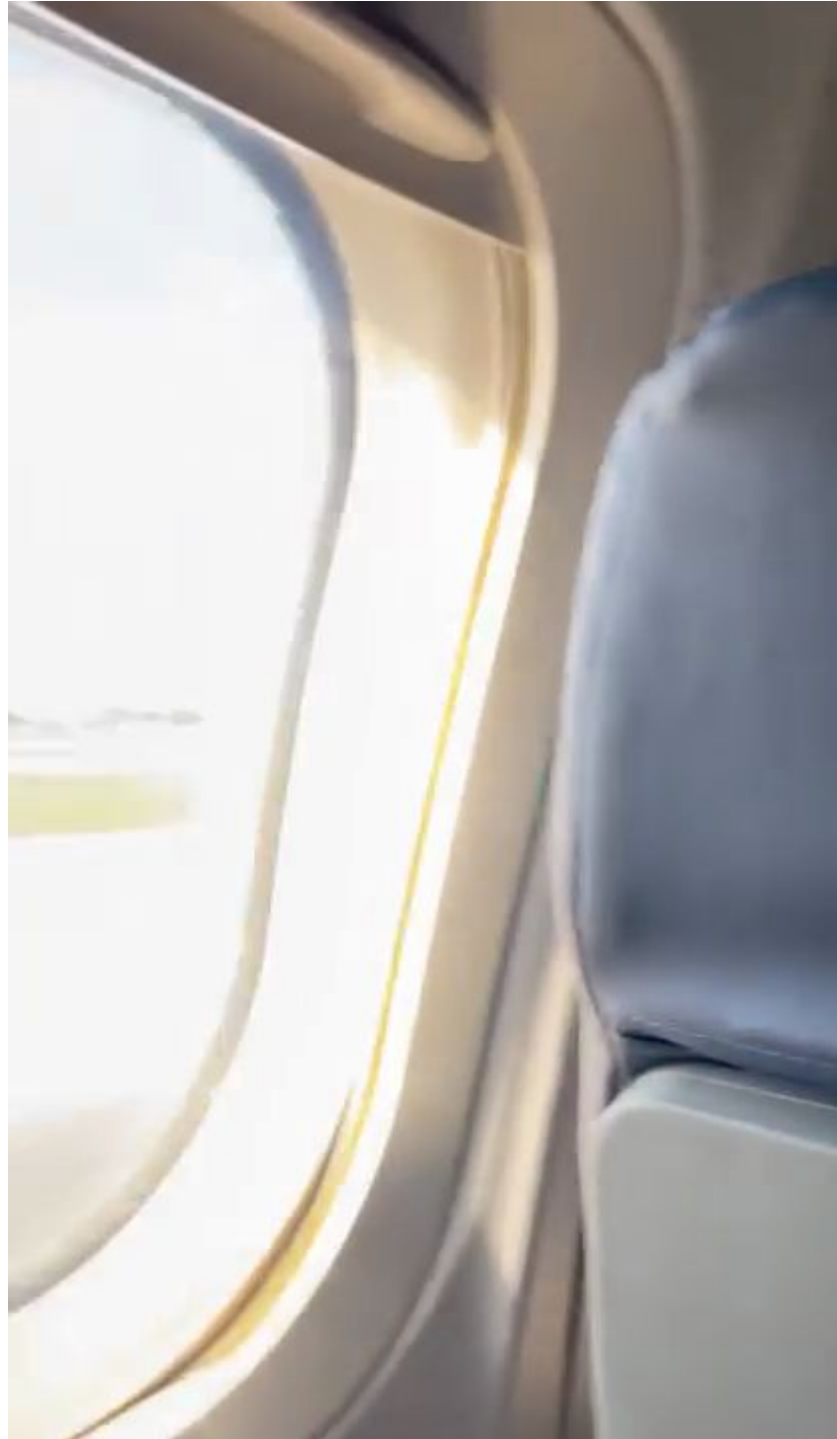

00283

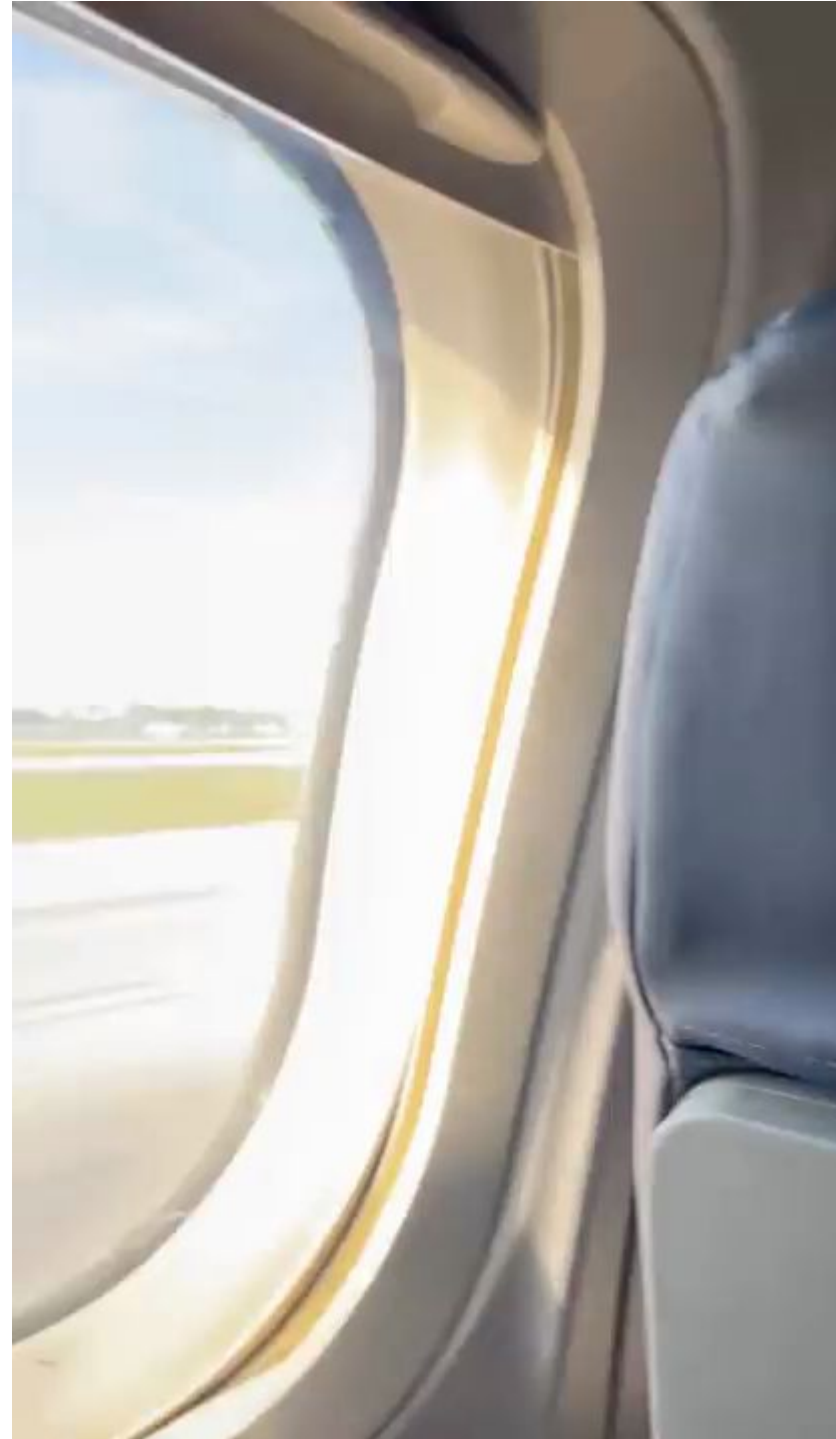

00284

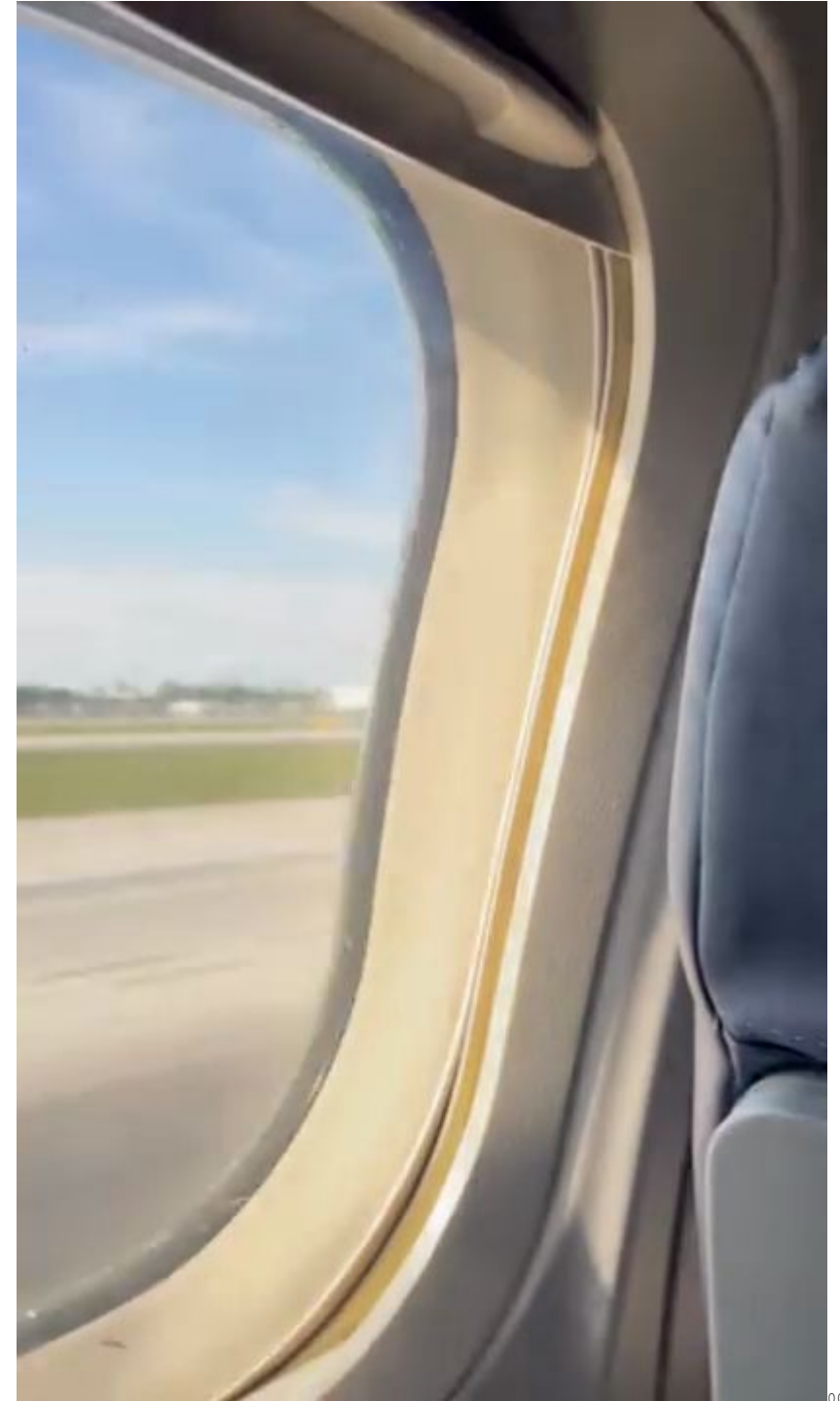

00285



00286



00287



00288



00289



00290



00291



00292



00293

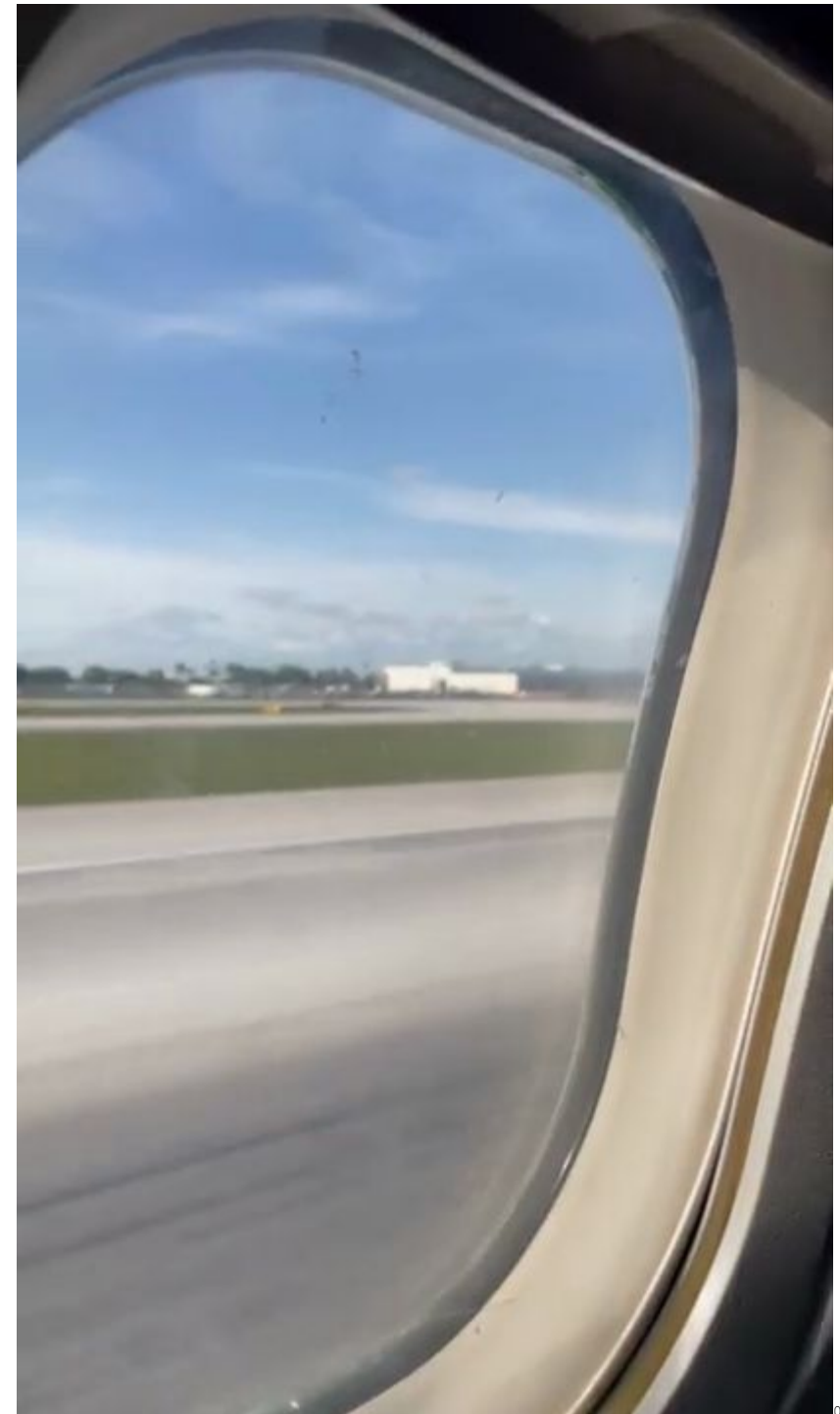

00294



00295



00296



00297



00298



00299

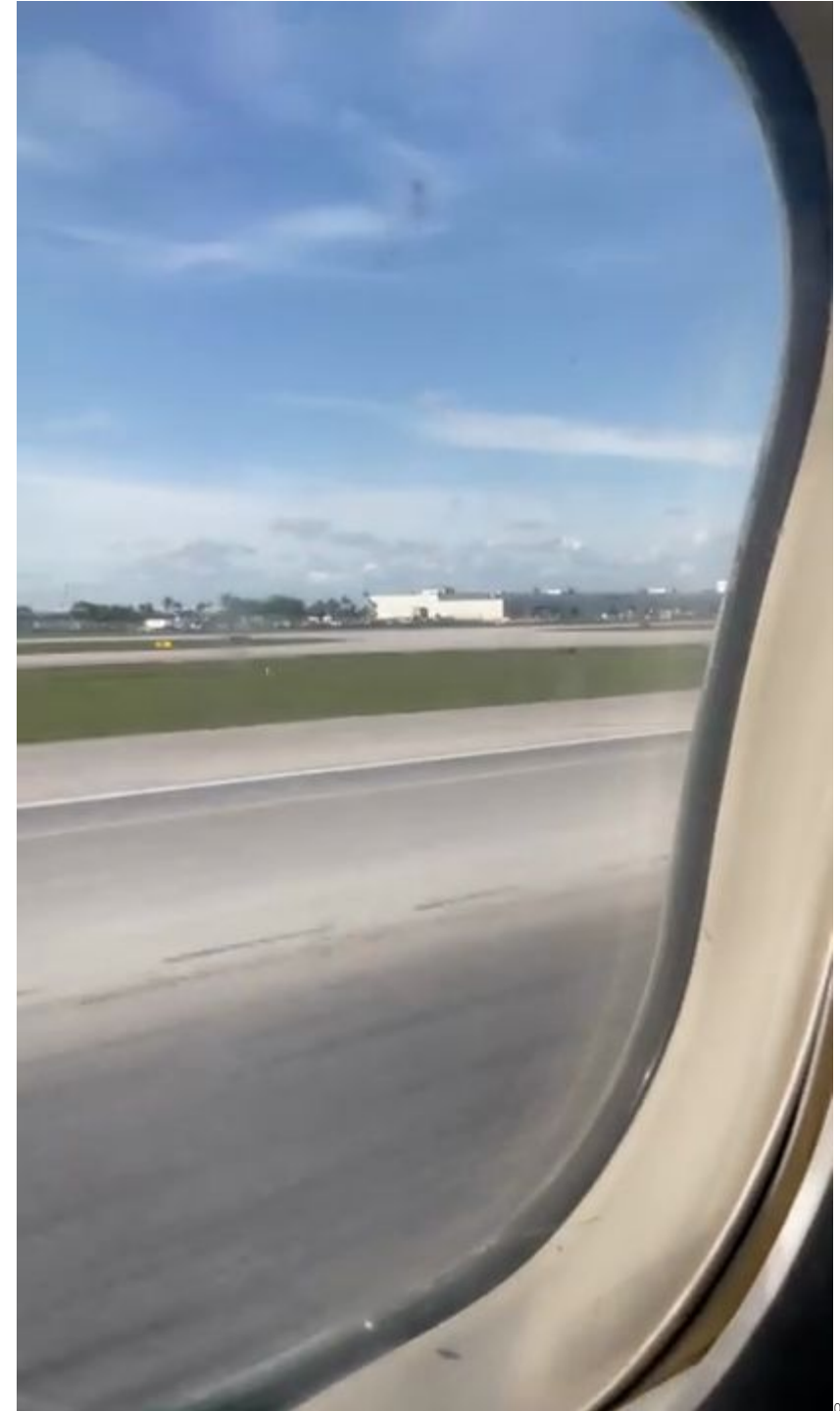

00300



00301



00302

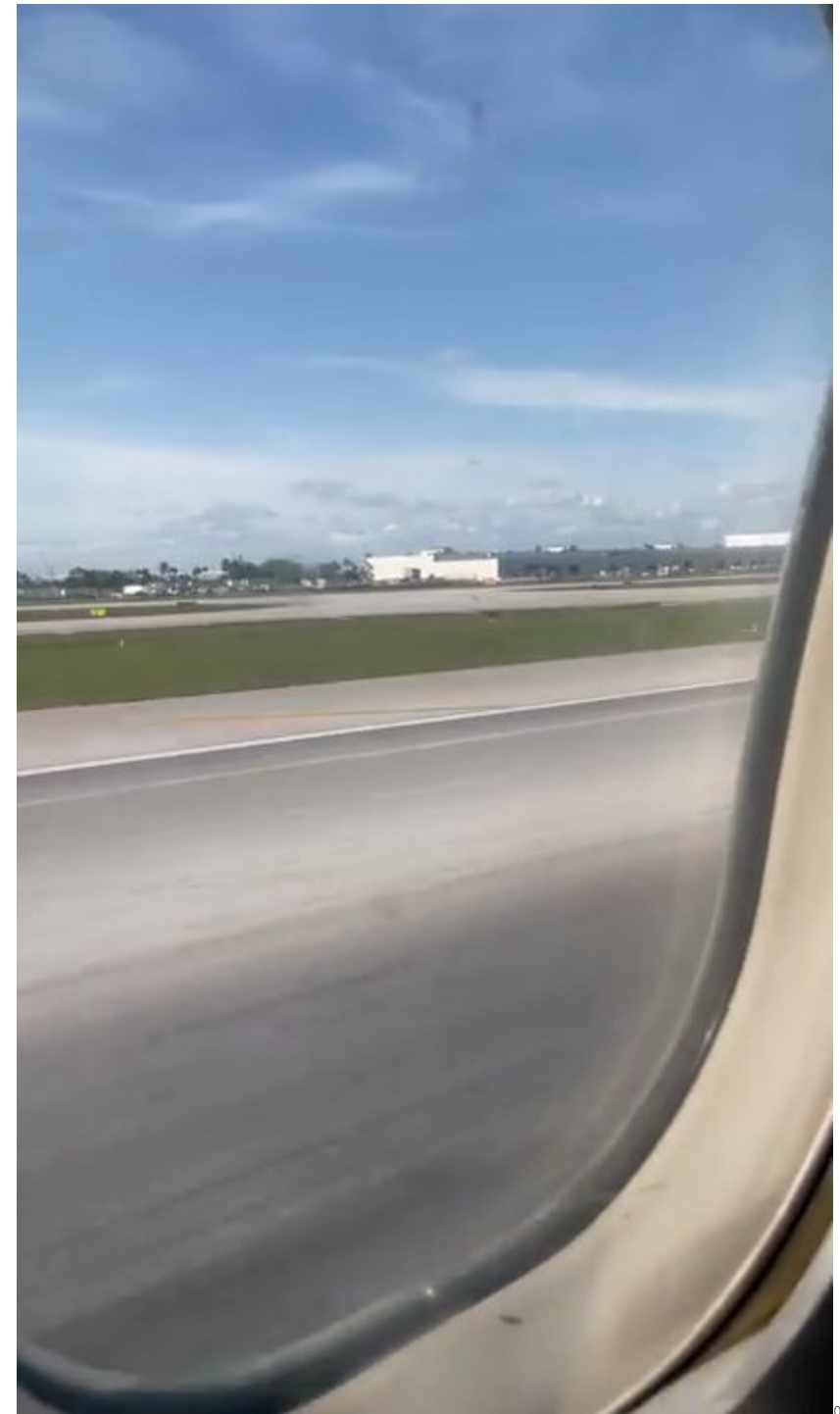

00303



00304



00305

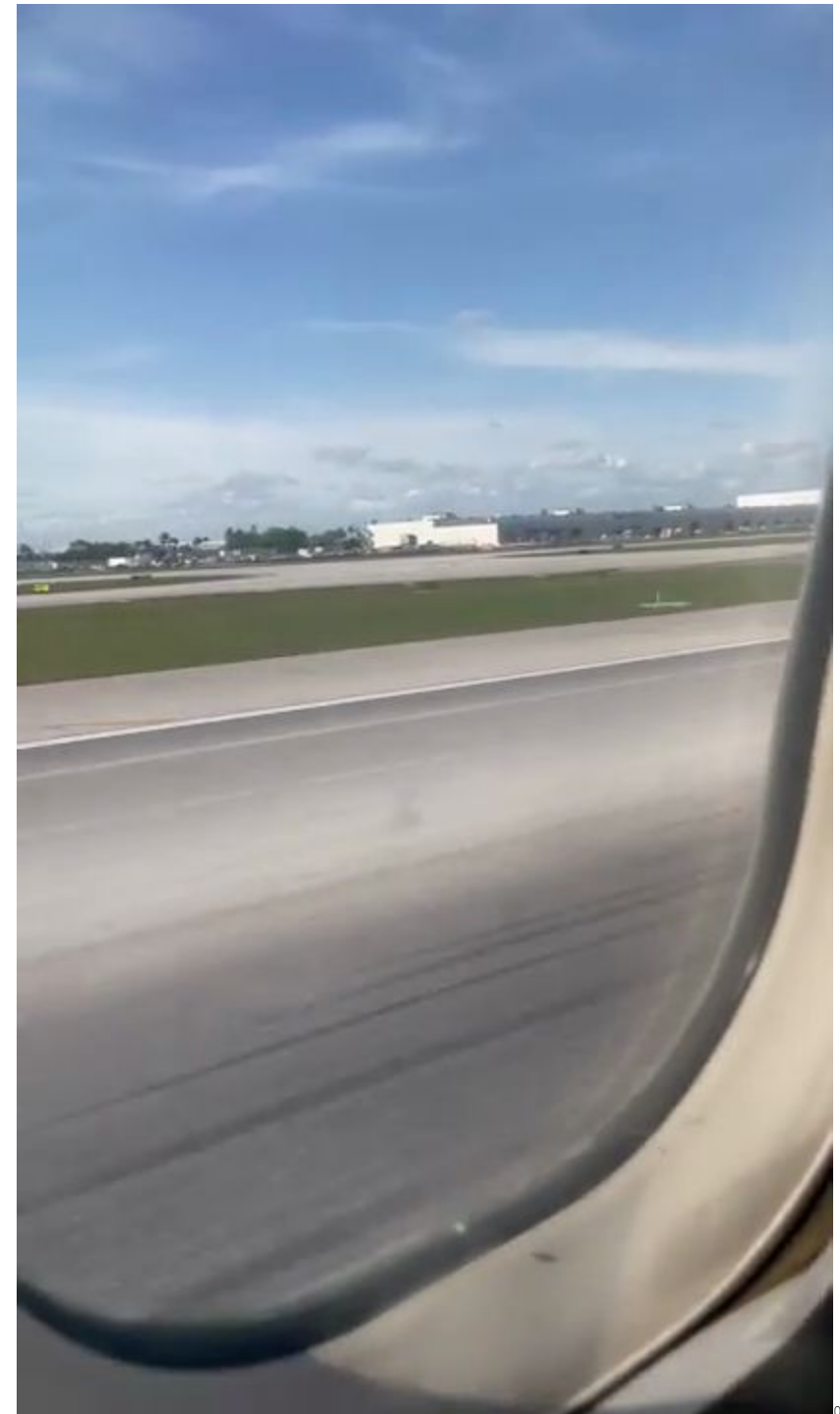

00306



00307



00308

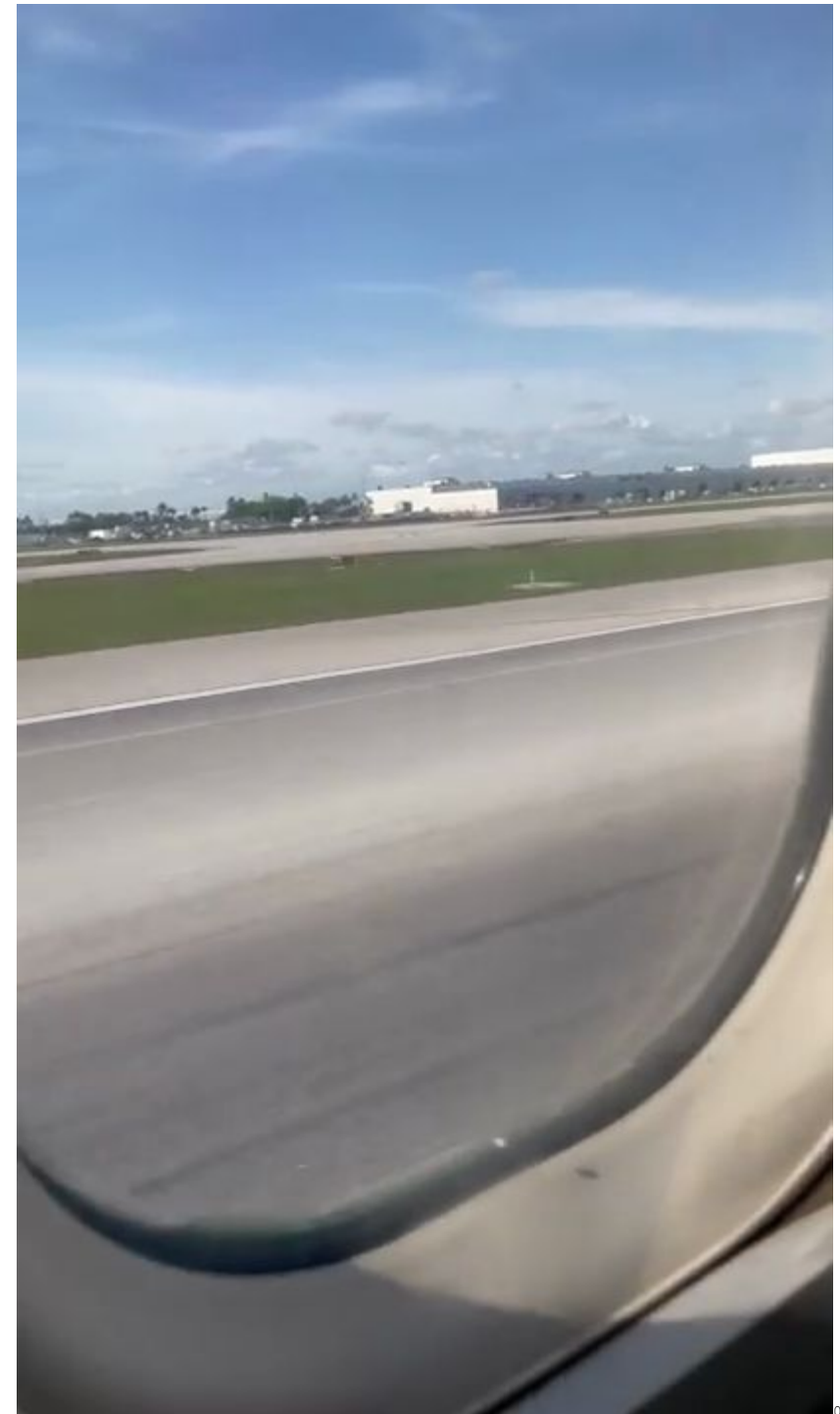

00309



00310



00311



00312



00313



00314



00315

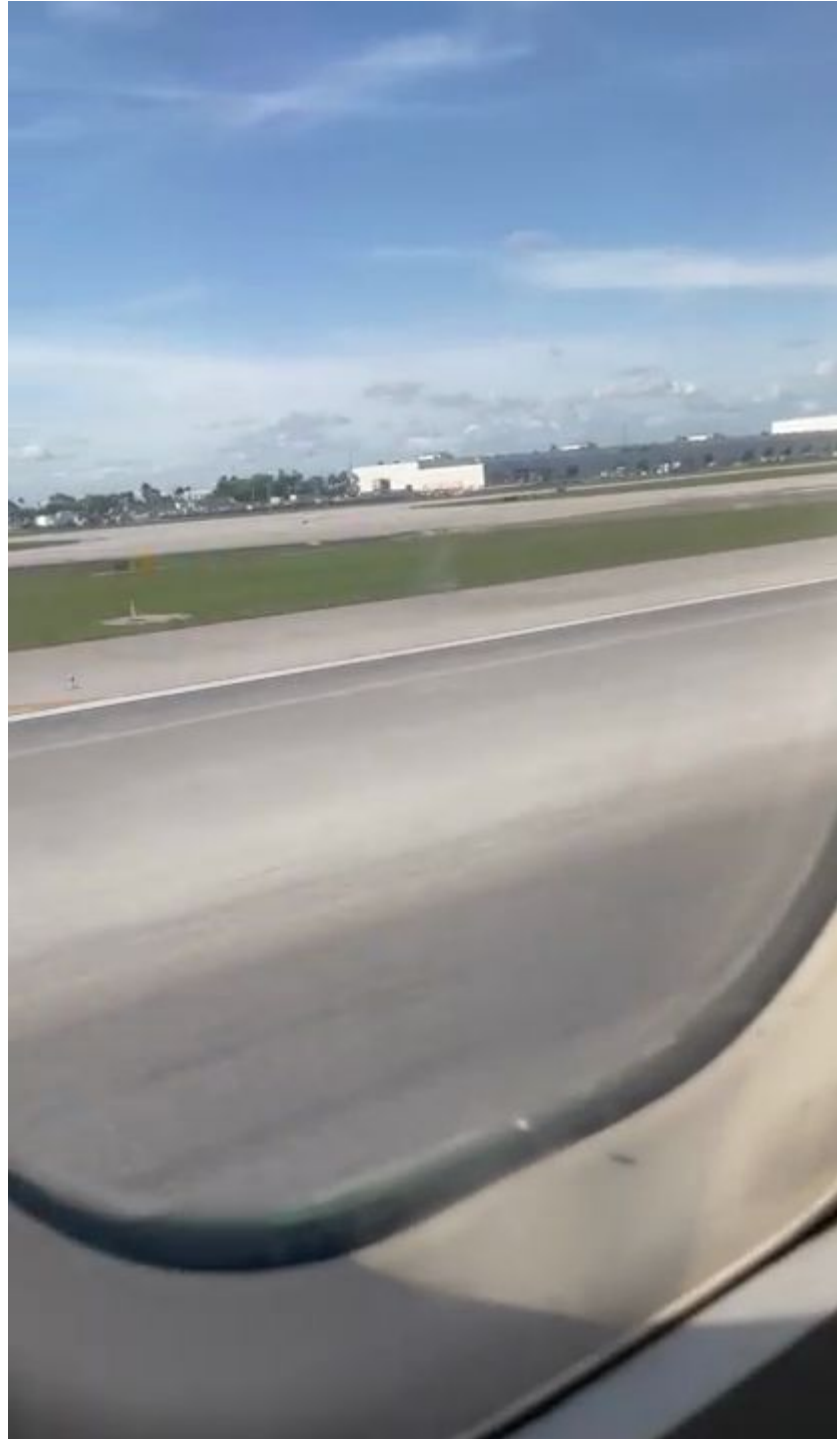

00316



00317



00318



00319



00320

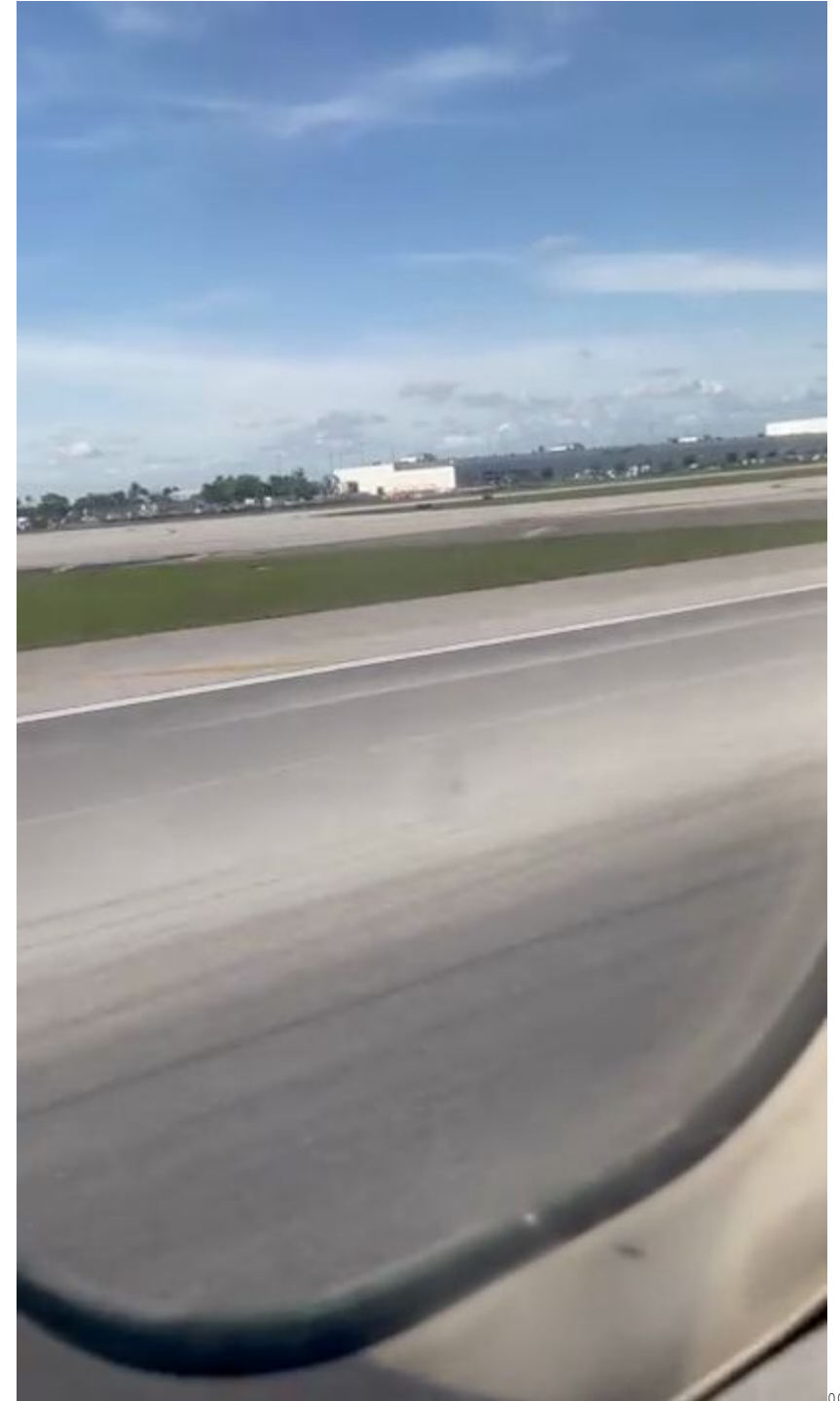

00321



00322



00323



00324



00325



00326

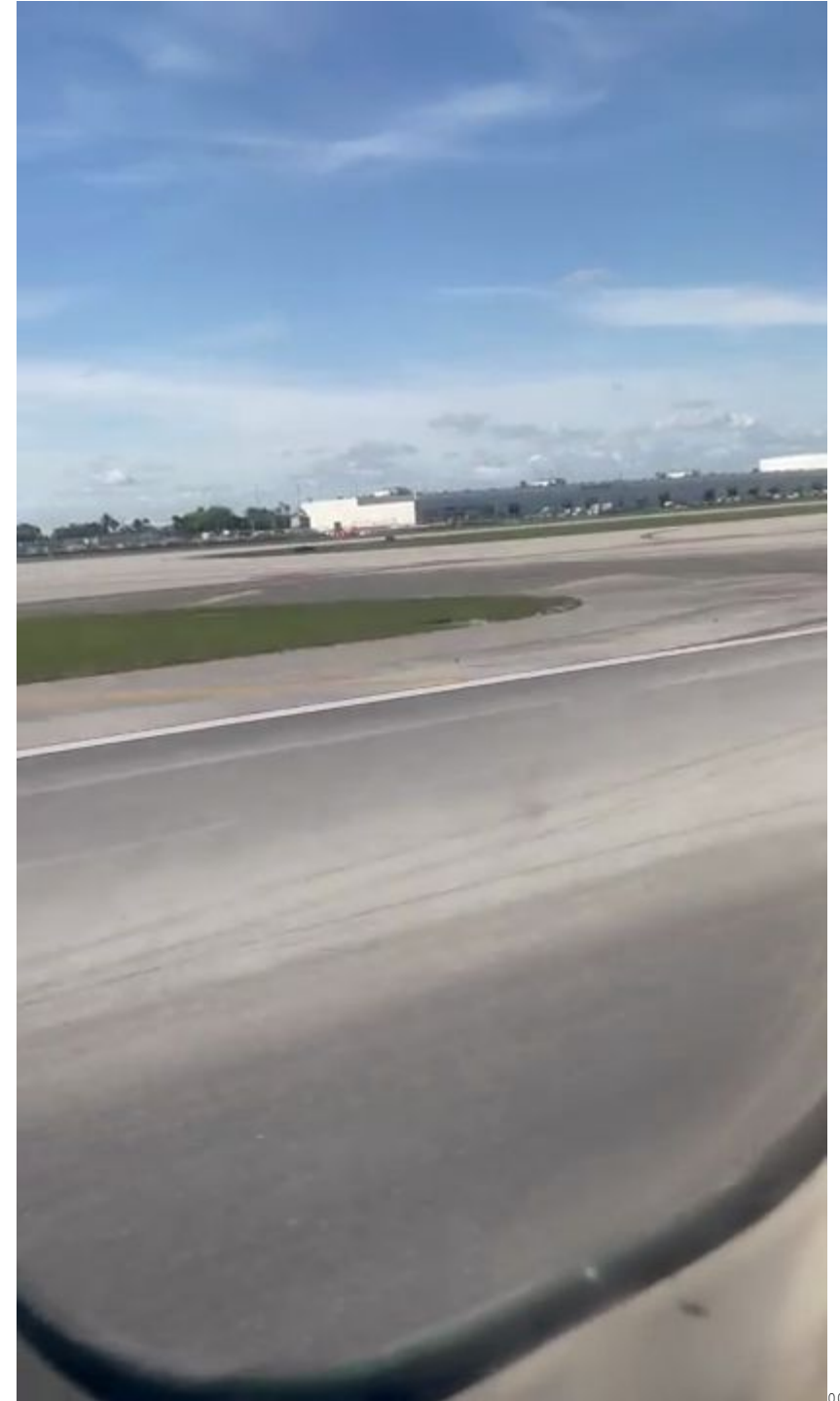

00327



00328



00329

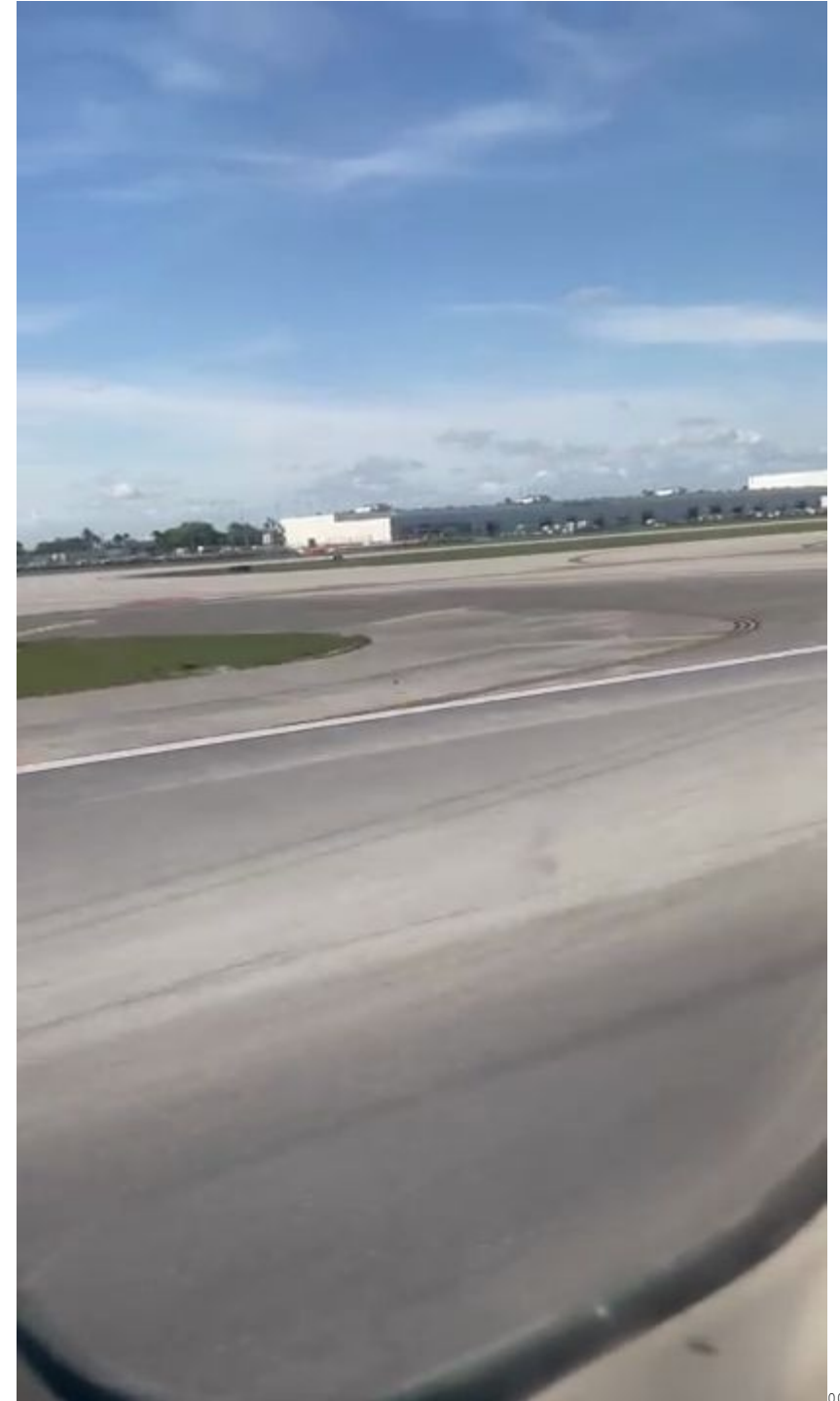

00330



00331



00332



00333



00334



00335

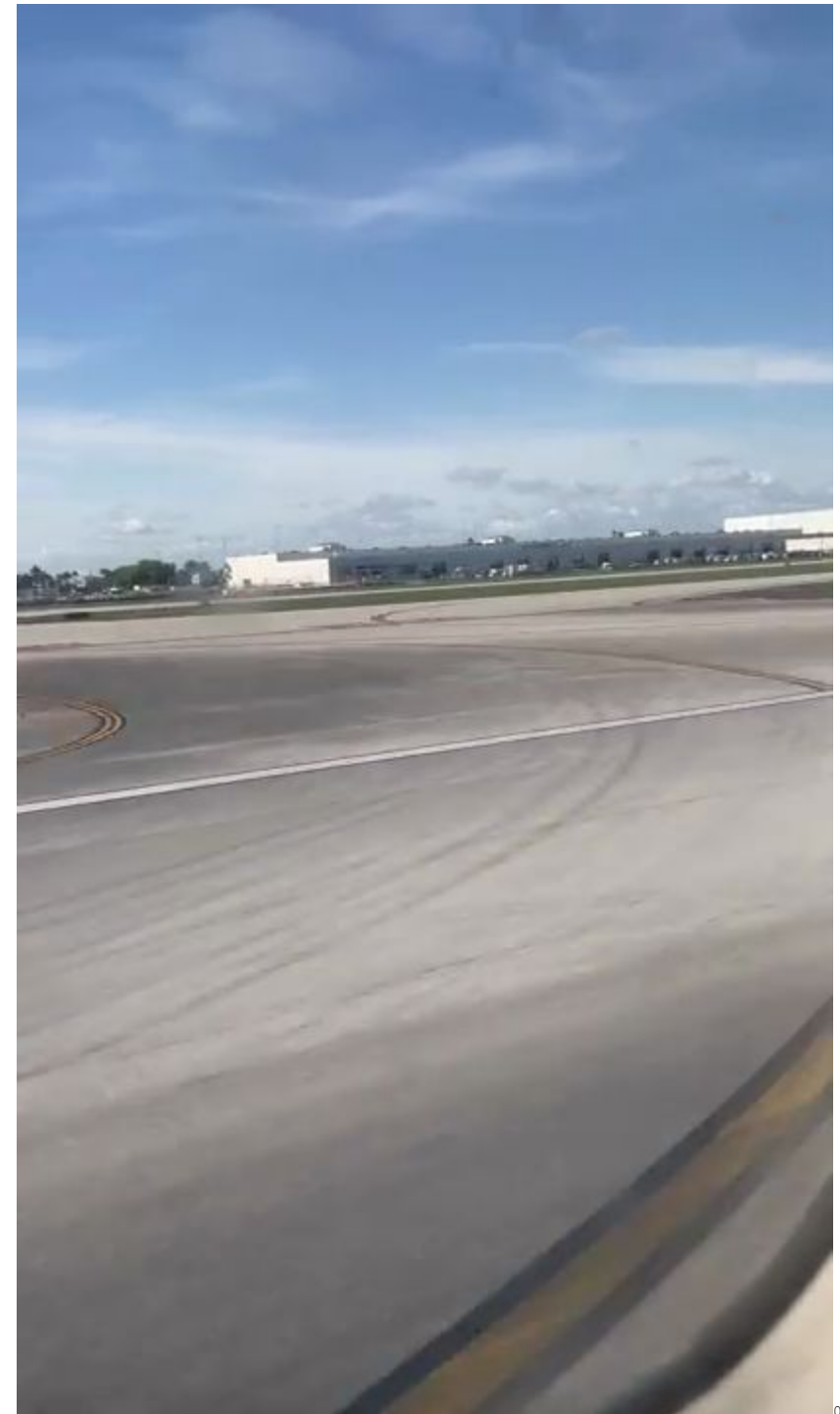

00336



00337



00338

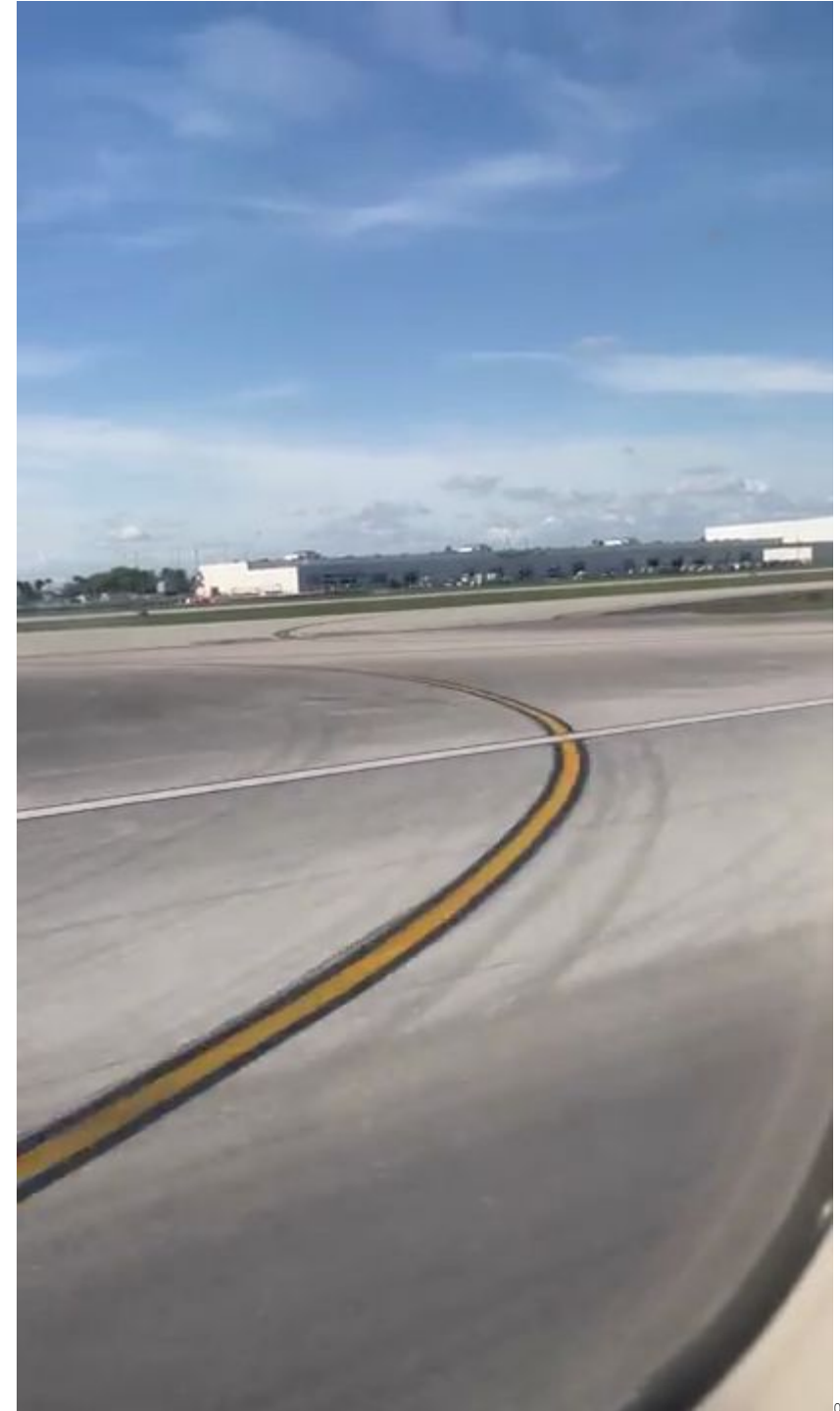

00339



00340



00341

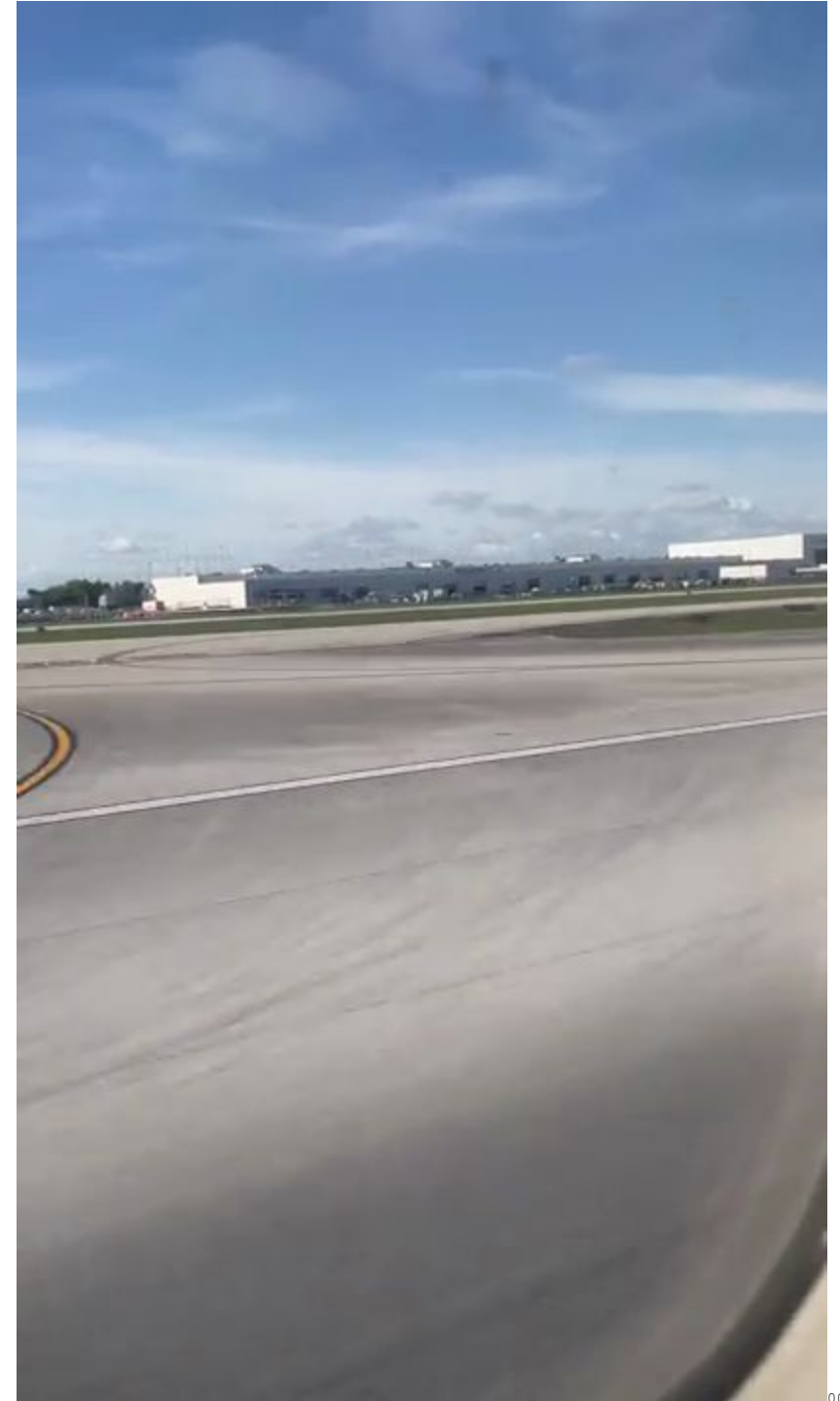

00342



00343



00344

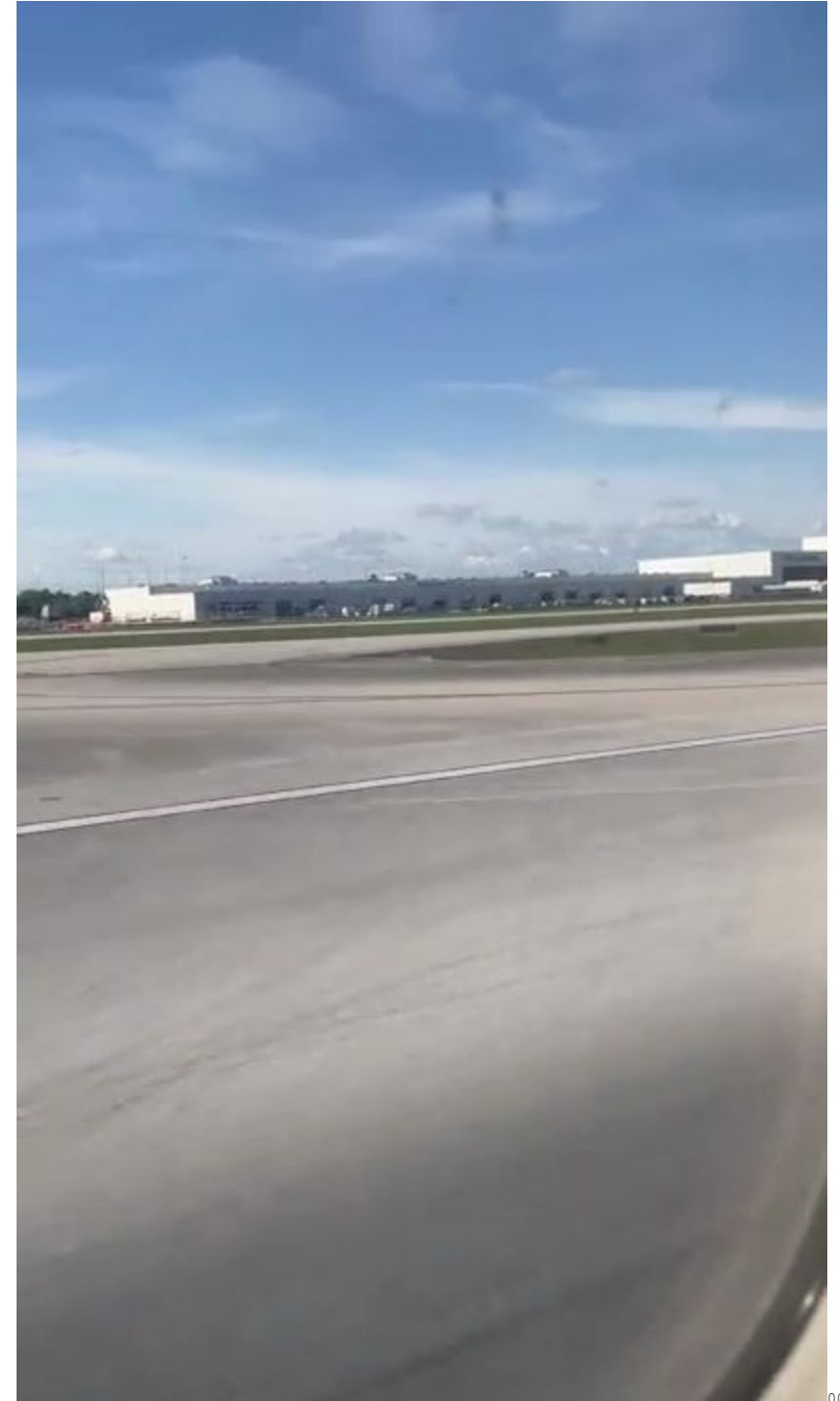

00345



00346



00347



00348



00349



00350



00351



00352



00353

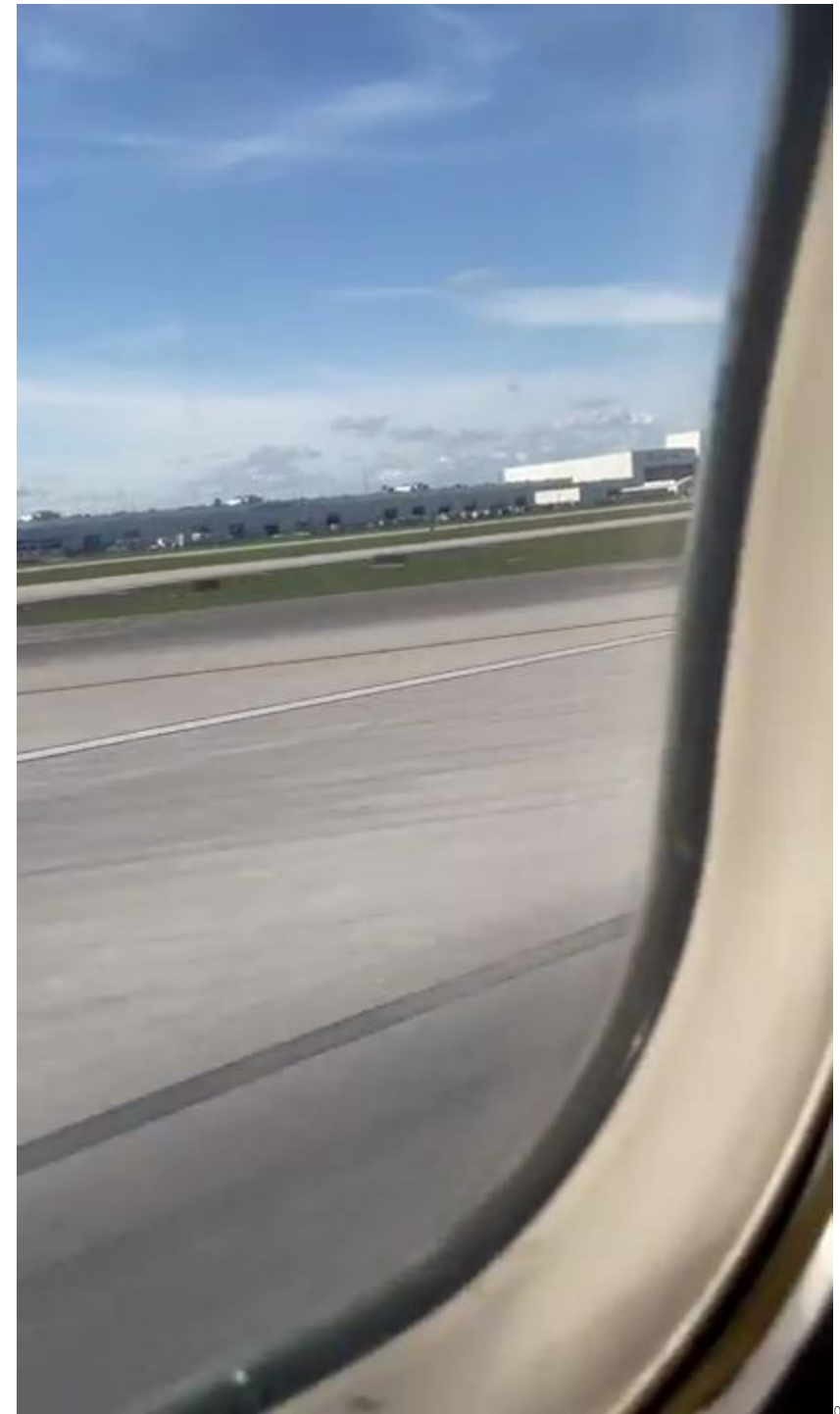

00354



00355



00356



00357

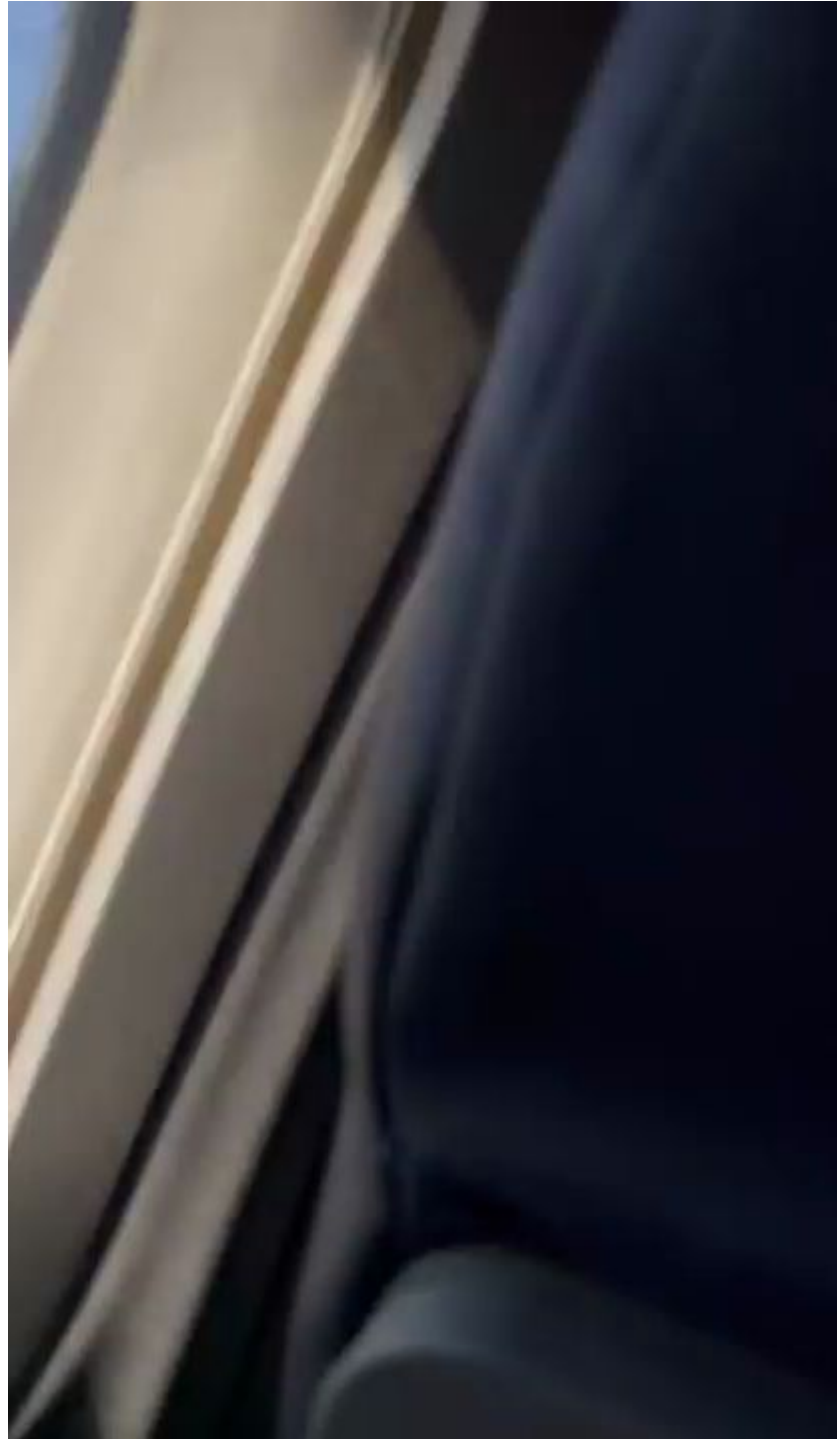

00358

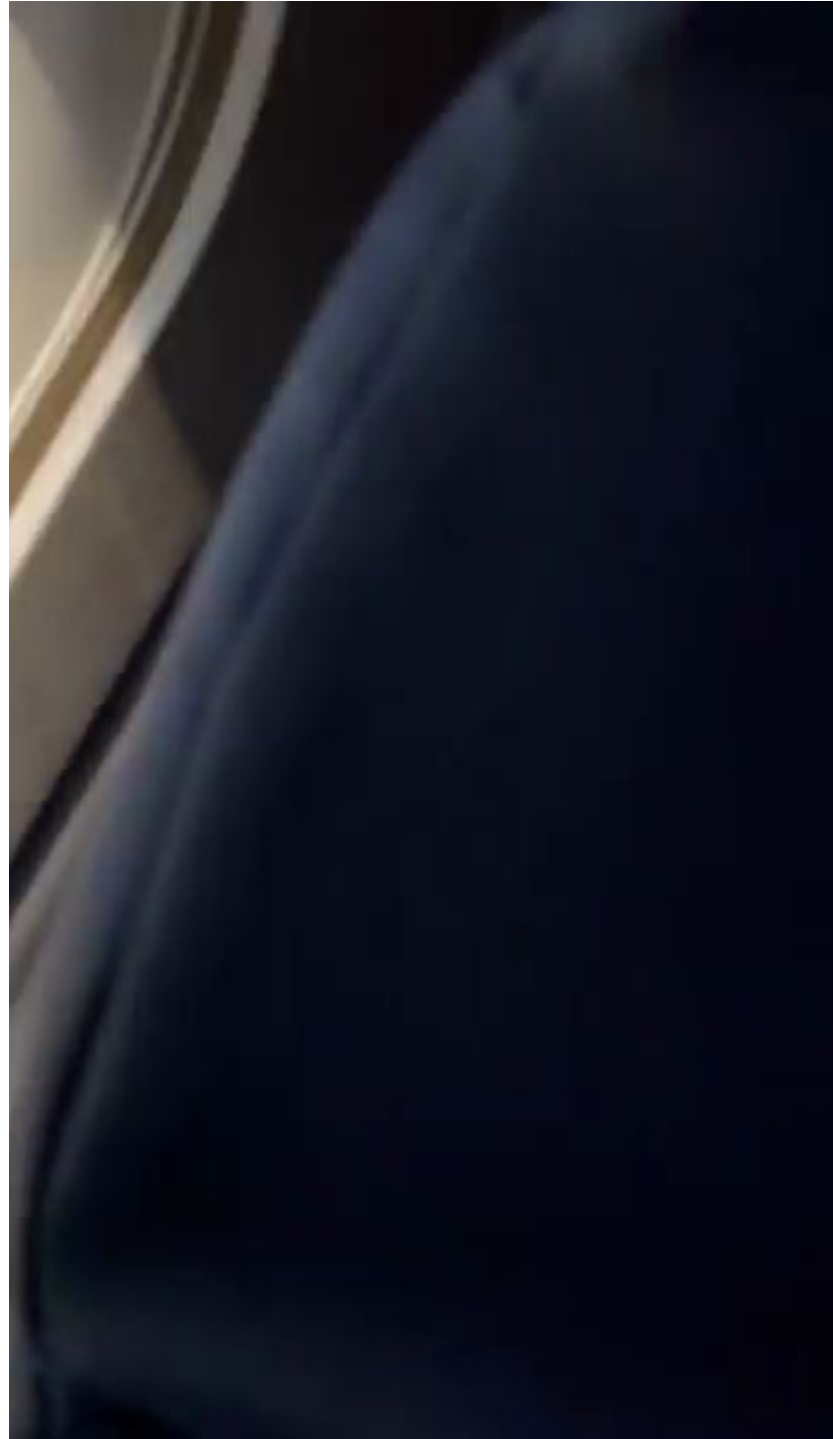

00359

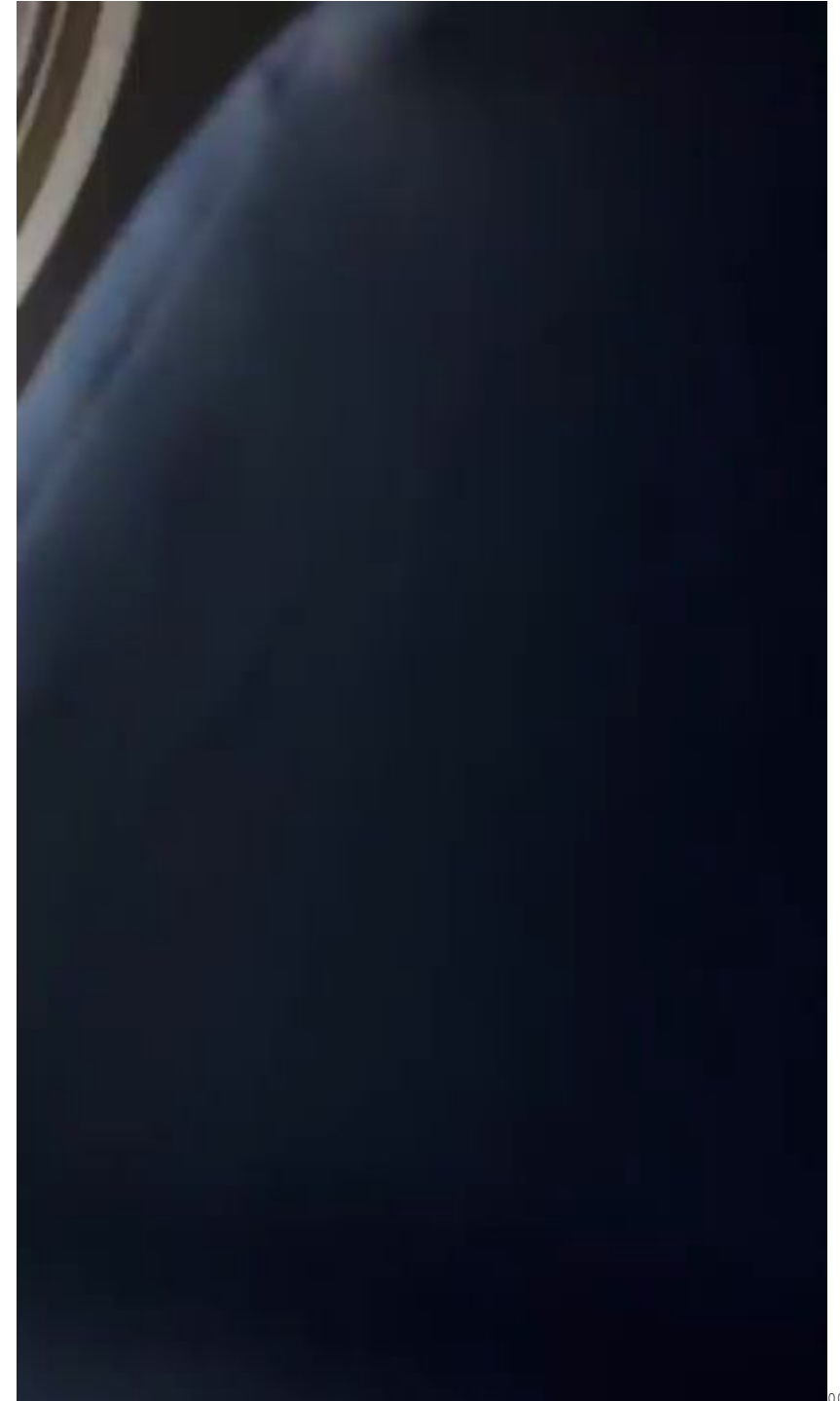

00360

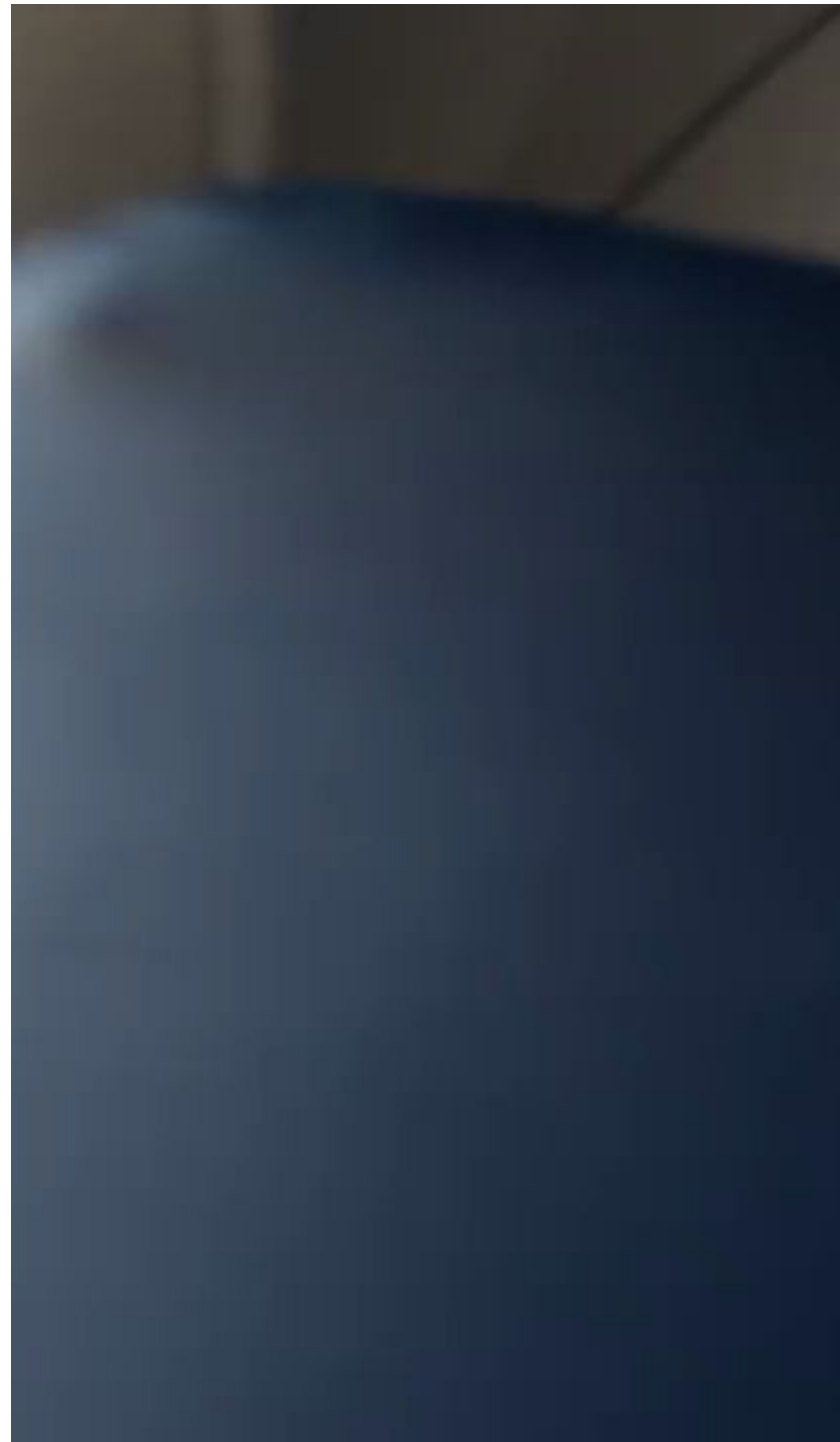

00361

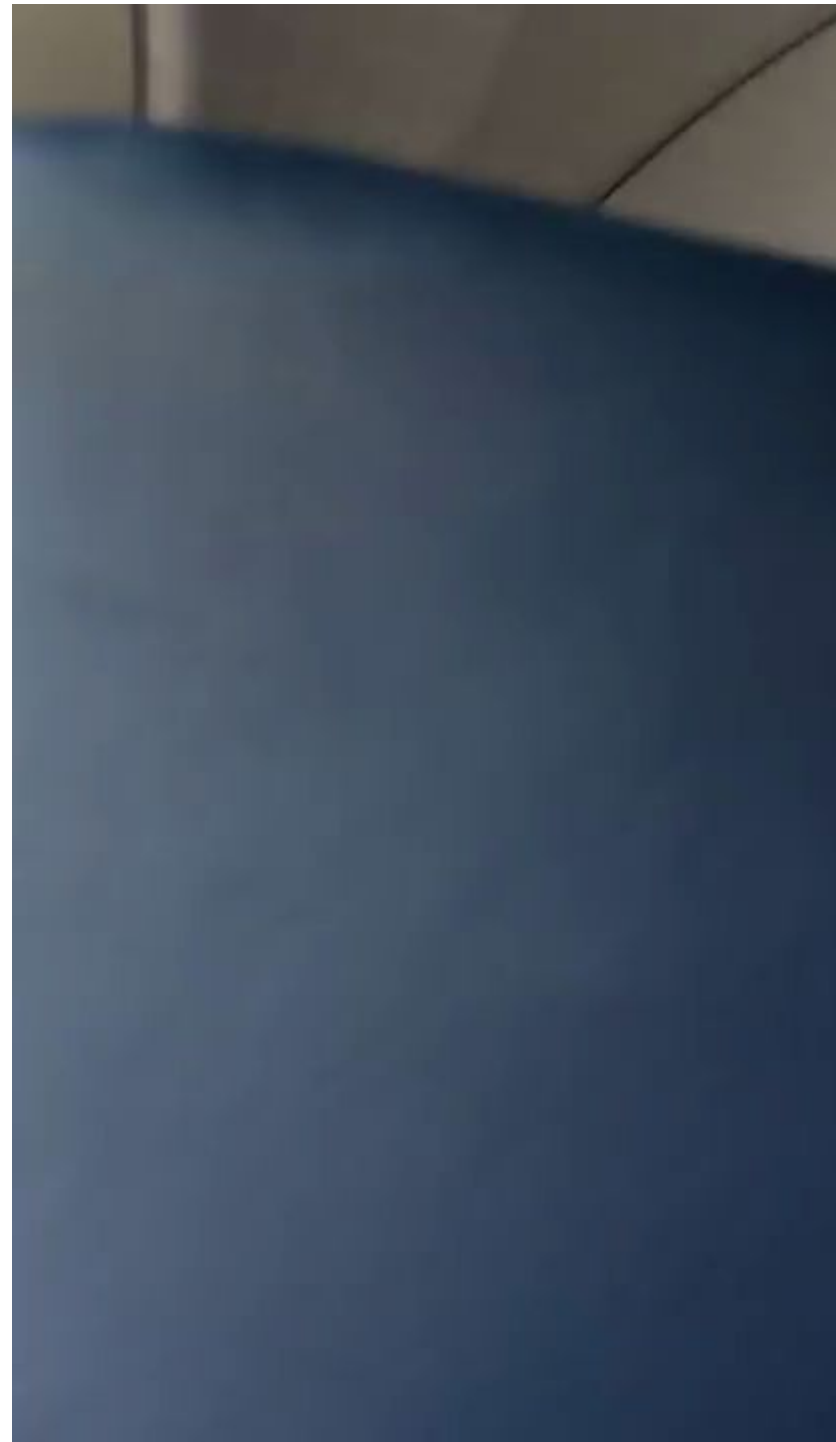

00362

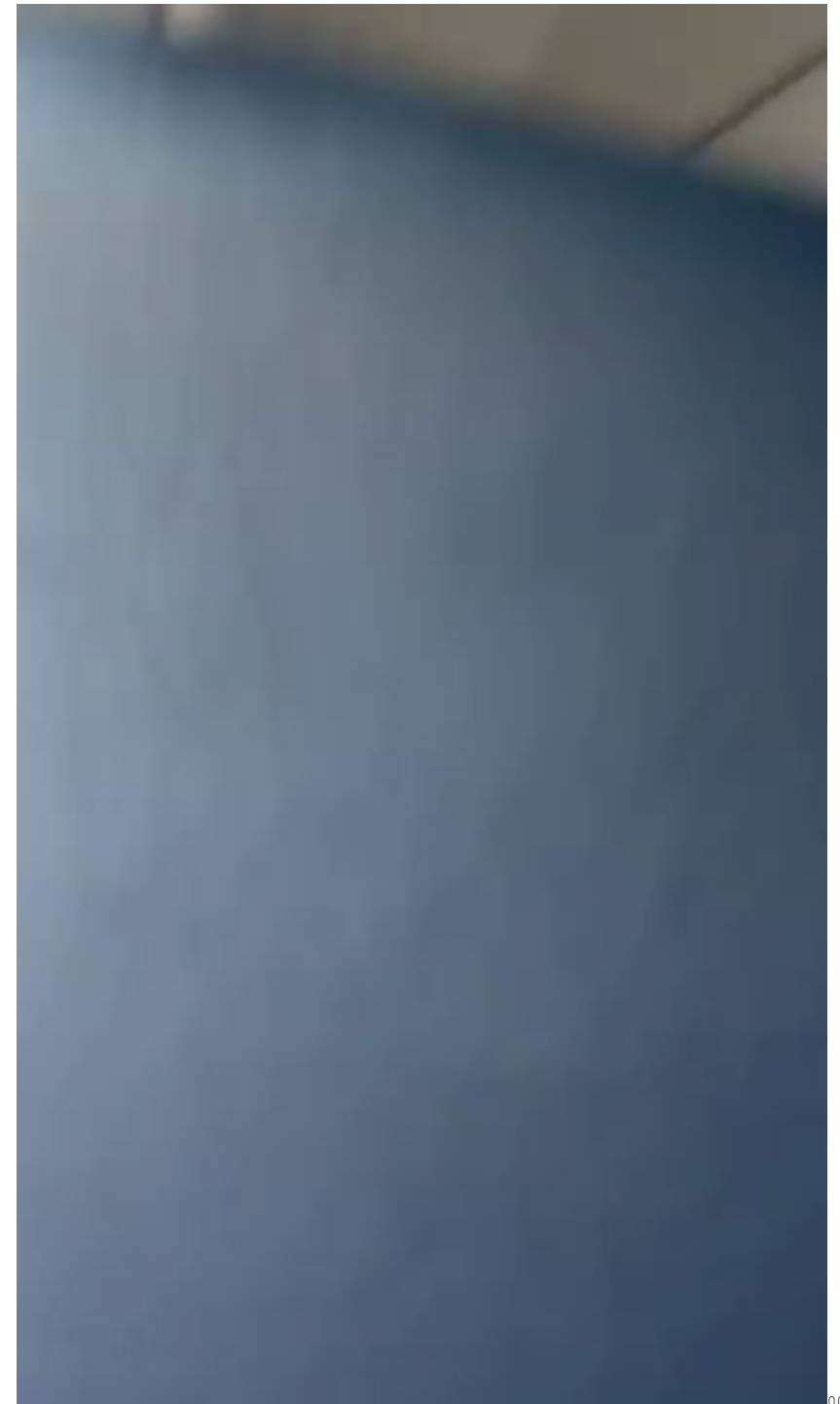

00363

ATTACHMENT 12: FLIGHT DATA RECORDER (FDR) DATA

RED AIR MCDONNELL DOUGLAS MD-82 RUNWAY EXCURSION AFTER LEFT MAIN LANDING GEAR FAILURE
MIAMI INTERNATIONAL AIRPORT (MIA), MIAMI, FL, JUNE 21, 2022 [FDR LONGITUDINAL & LATERAL-DIRECTIONAL PARAMETERS]

NATIONAL TRANSPORTATION SAFETY BOARD

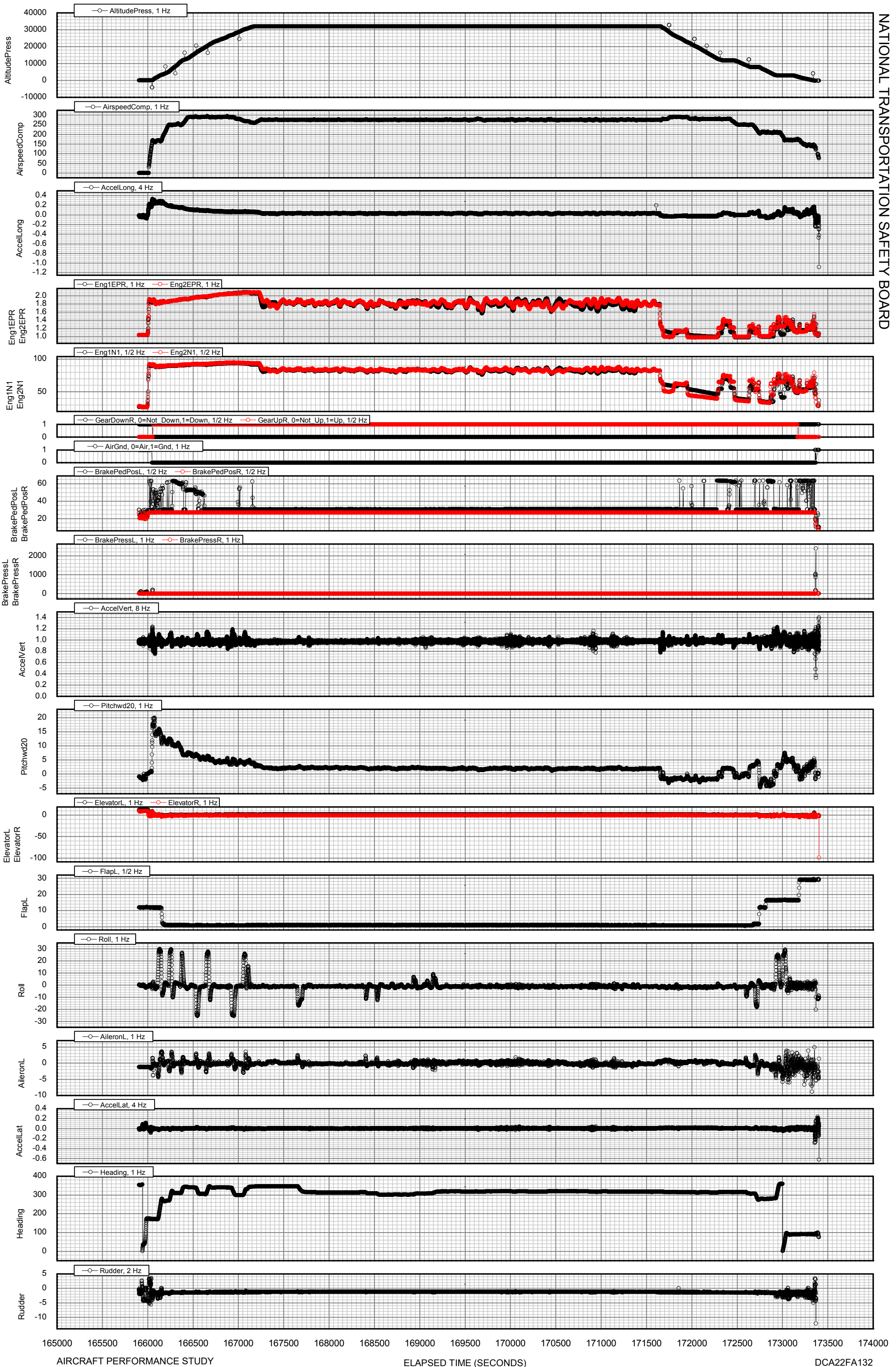

RED AIR MCDONNELL DOUGLAS MD-82 RUNWAY EXCURSION AFTER LEFT MAIN LANDING GEAR FAILURE
MIAMI INTERNATIONAL AIRPORT (MIA), MIAMI, FL, JUNE 21, 2022 [FDR LONGITUDINAL & LATERAL-DIRECTIONAL PARAMETERS]

NATIONAL TRANSPORTATION SAFETY BOARD

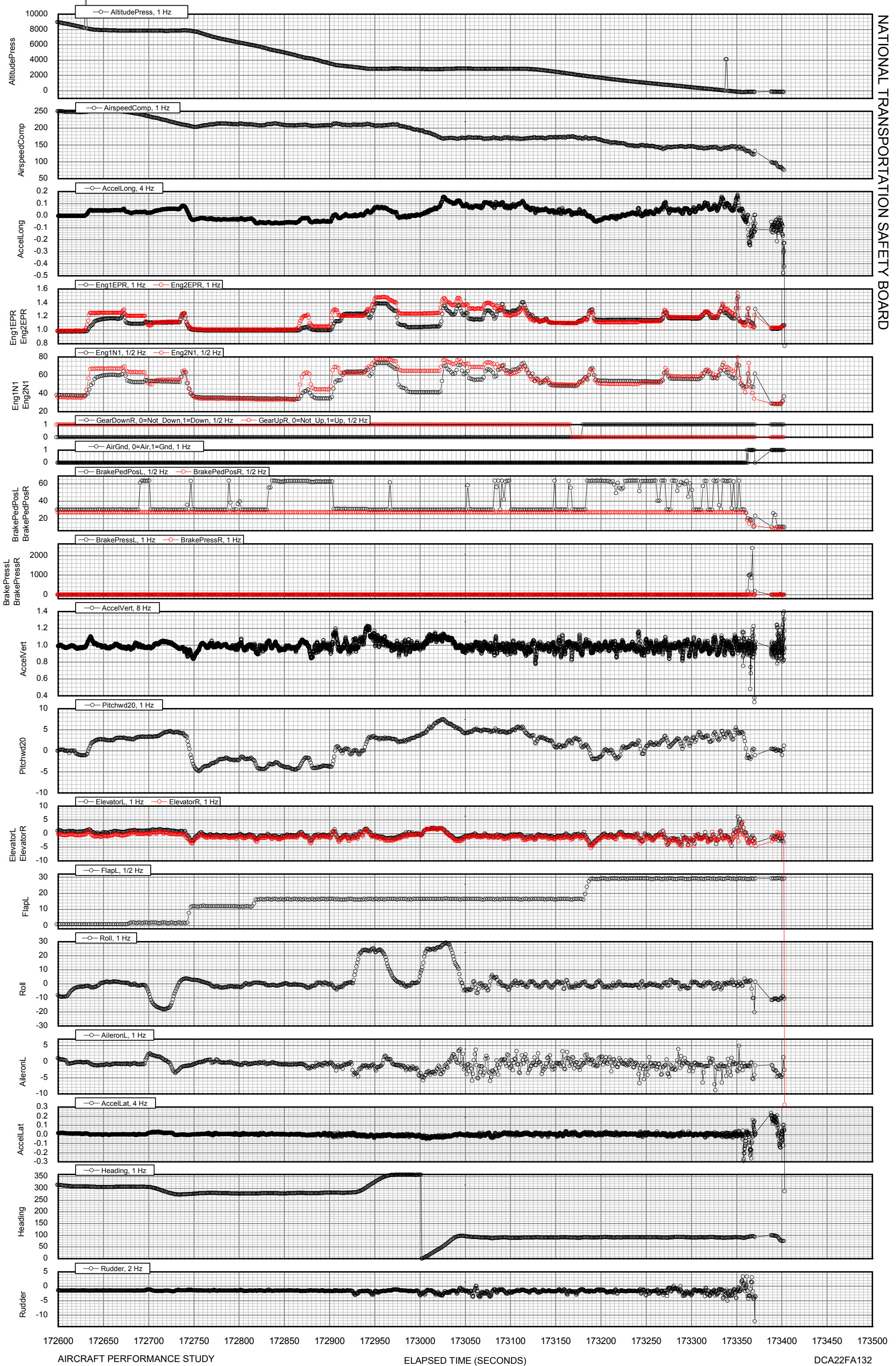

RED AIR MCDONNELL DOUGLAS MD-82 RUNWAY EXCURSION AFTER LEFT MAIN LANDING GEAR FAILURE
MIAMI INTERNATIONAL AIRPORT (MIA), MIAMI, FL, JUNE 21, 2022 [FDR LONGITUDINAL & LATERAL-DIRECTIONAL PARAMETERS]

NATIONAL TRANSPORTATION SAFETY BOARD

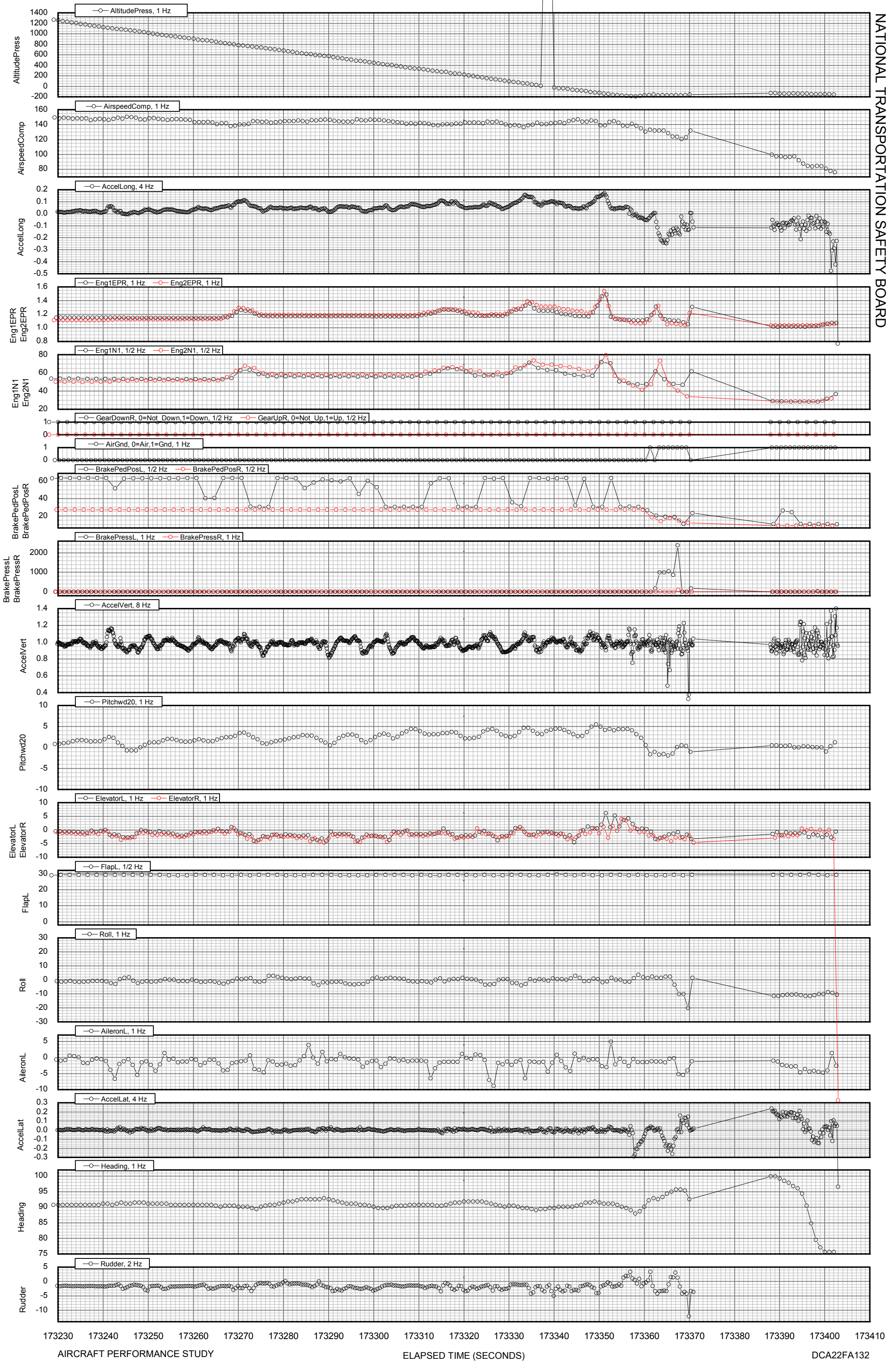

ATTACHMENT 13: PARAPHRASED CVR EVENTS OVERLAID ON FDR DATA

RED AIR MCDONNELL DOUGLAS MD-82 (HI-1064) RUNWAY EXCURSION AFTER LEFT MAIN LANDING GEAR FAILURE MIAMI INTERNATIONAL AIRPORT (MIA), MIAMI, FL, JUNE 21, 2022 [FDR LONGITUDINAL & LATERAL-DIRECTIONAL PARAMETERS]

NATIONAL TRANSPORTATION SAFETY BOARD

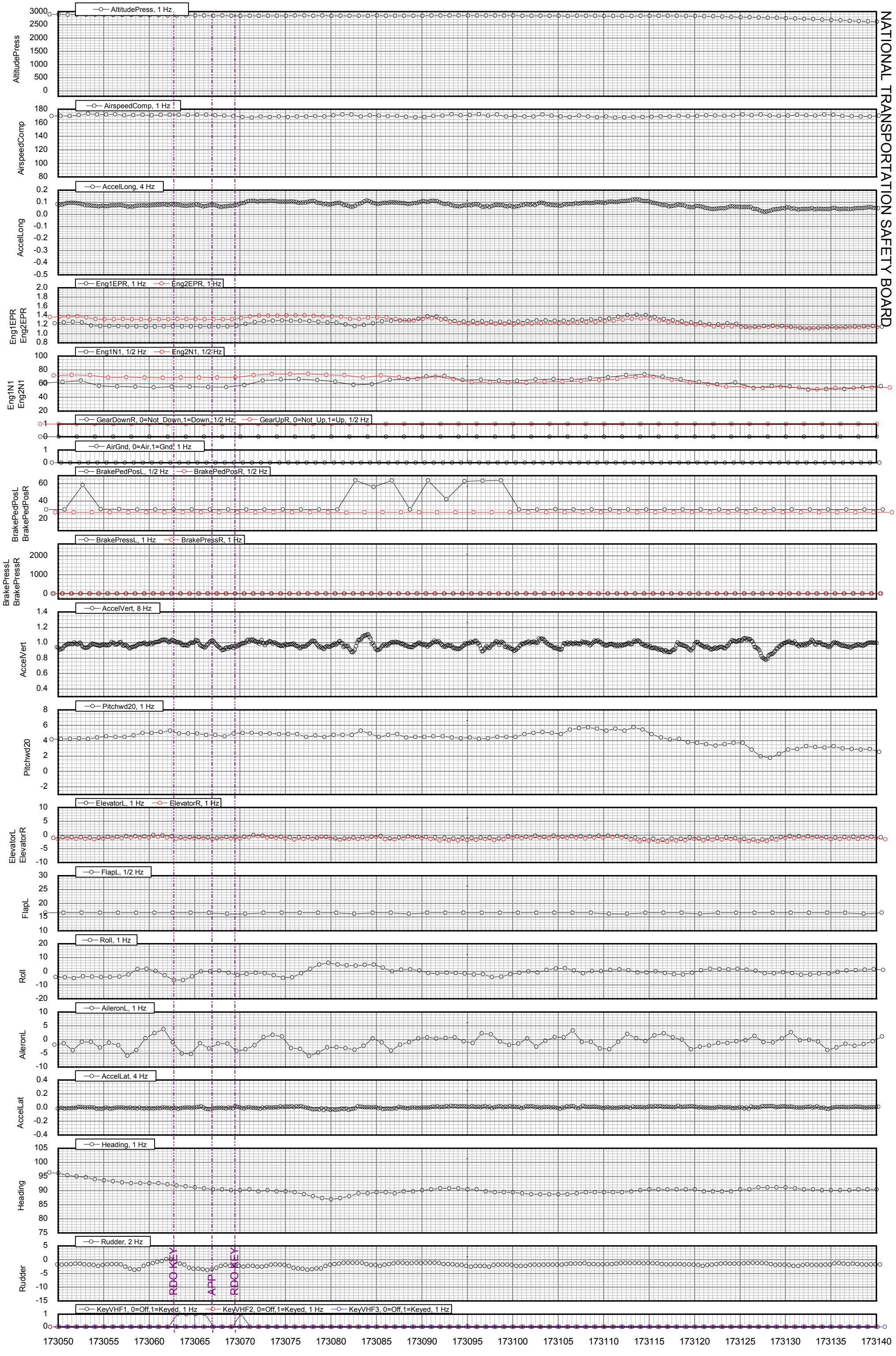

RED AIR MCDONNELL DOUGLAS MD-82 (HI-1064) RUNWAY EXCURSION AFTER LEFT MAIN LANDING GEAR FAILURE MIAMI INTERNATIONAL AIRPORT (MIA), MIAMI, FL, JUNE 21, 2022 [FDR LONGITUDINAL & LATERAL-DIRECTIONAL PARAMETERS]

NATIONAL TRANSPORTATION SAFETY BOARD

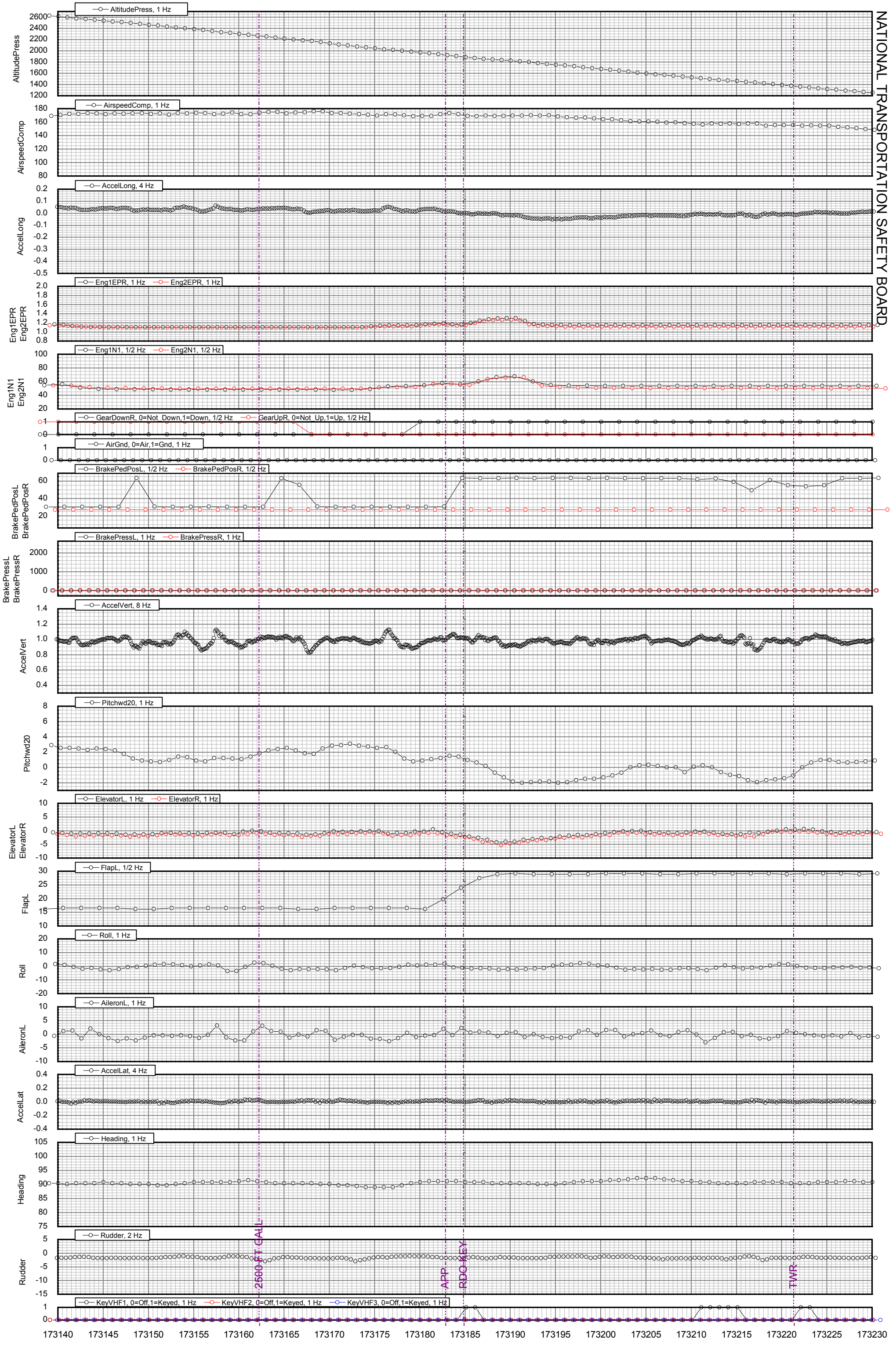

RED AIR MCDONNELL DOUGLAS MD-82 (HI-1064) RUNWAY EXCURSION AFTER LEFT MAIN LANDING GEAR FAILURE MIAMI INTERNATIONAL AIRPORT (MIA), MIAMI, FL, JUNE 21, 2022 [FDR LONGITUDINAL & LATERAL-DIRECTIONAL PARAMETERS]

NATIONAL TRANSPORTATION SAFETY BOARD

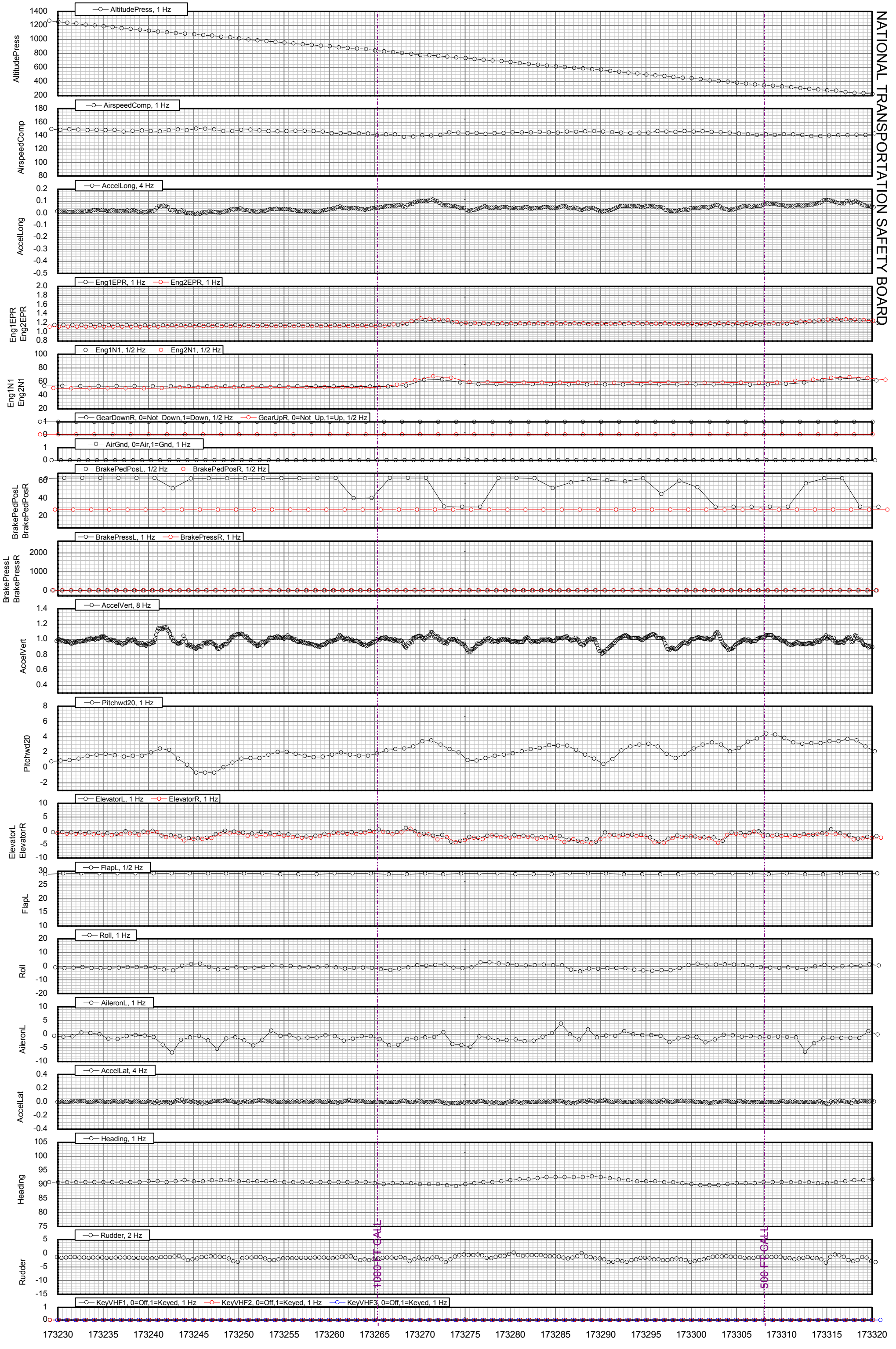

RED AIR MCDONNELL DOUGLAS MD-82 (HI-1064) RUNWAY EXCURSION AFTER LEFT MAIN LANDING GEAR FAILURE MIAMI INTERNATIONAL AIRPORT (MIA), MIAMI, FL, JUNE 21, 2022 [FDR LONGITUDINAL & LATERAL-DIRECTIONAL PARAMETERS]

NATIONAL TRANSPORTATION SAFETY BOARD

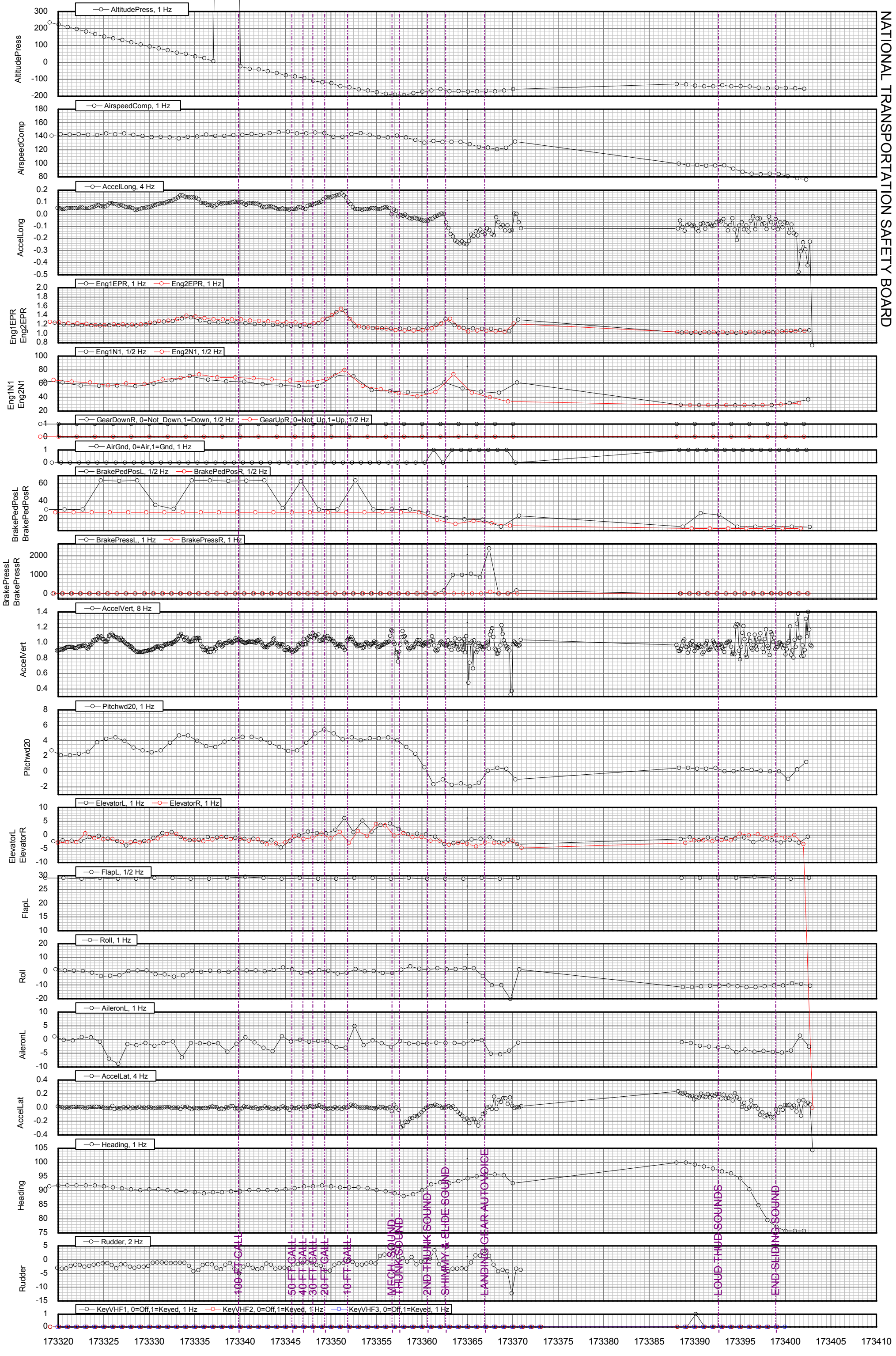

ATTACHMENT 14: ACCIDENT FLIGHT RECONSTRUCTION (HI1064)

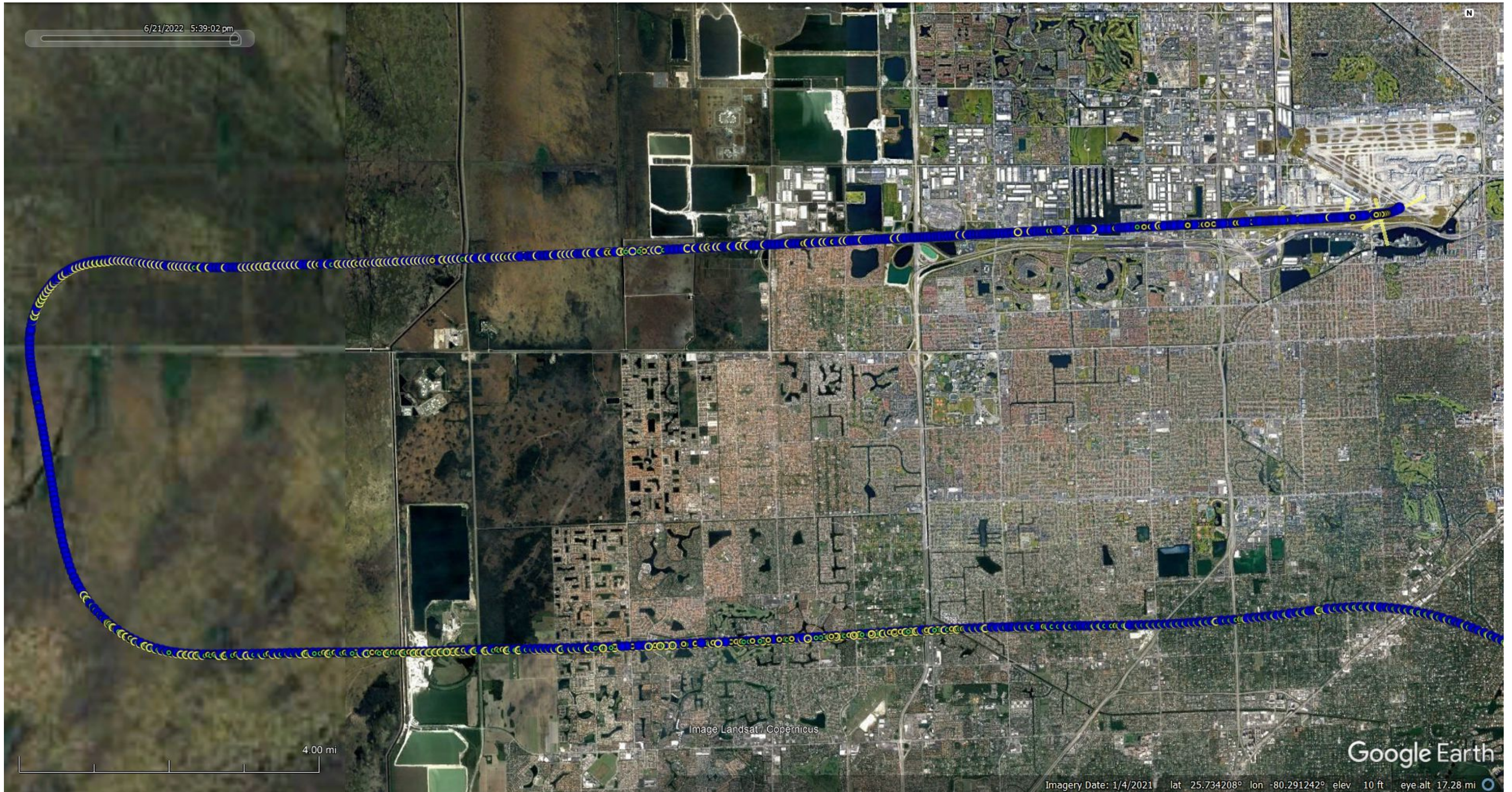

Figure A14.1: Overhead view of HI1064 accident flightpath. Ground track reconstruction is based on FAA ADS-B, paraphrased CVR, FDR, video, and runway witness mark evidence. Aircraft direction of travel is clockwise from lower right to upper right. Due north is toward the top of the page.

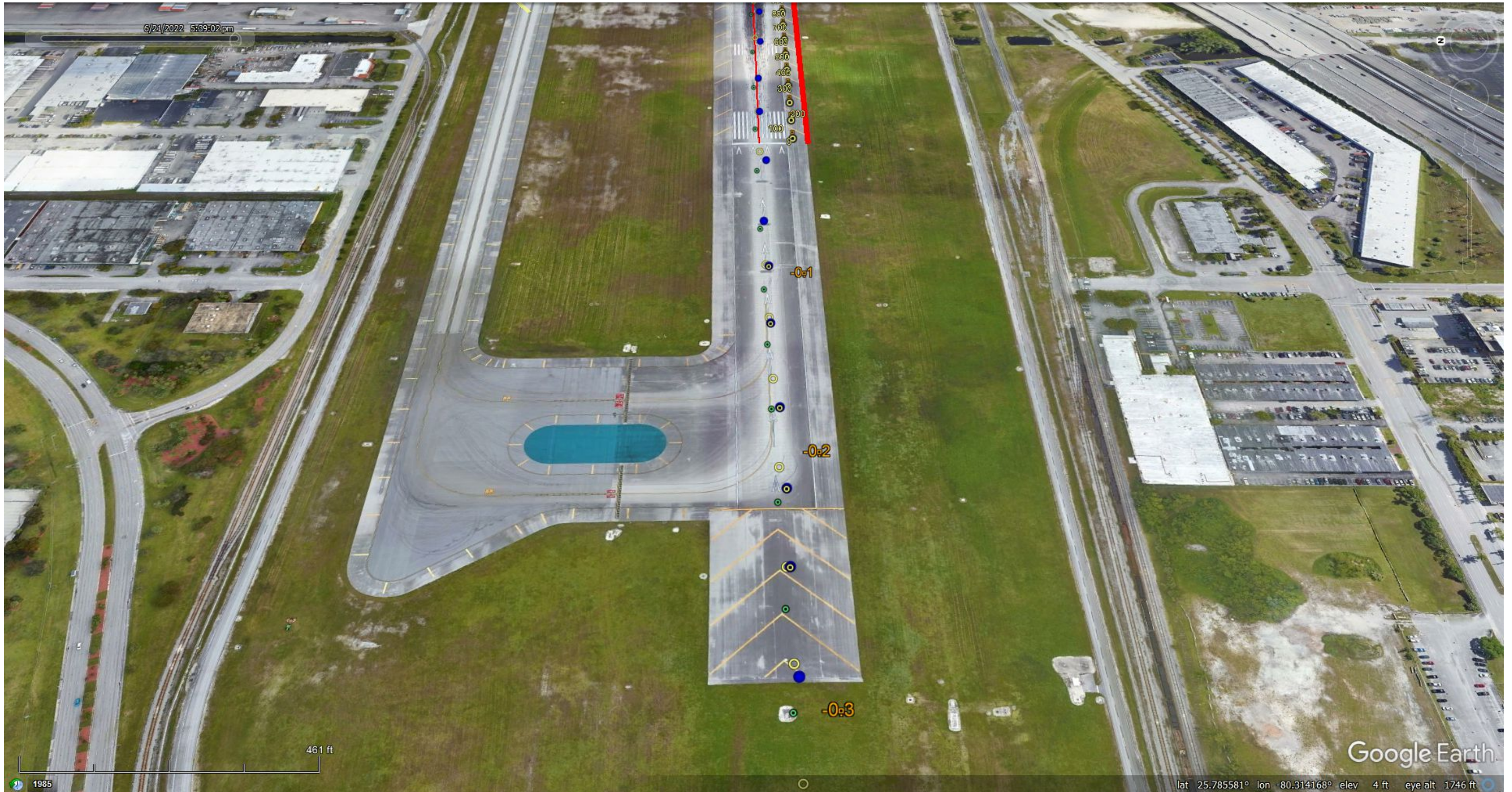

Figure A14.2: HI1064 accident flight reconstruction looking toward the approach end of runway 9. Ground track reconstruction is based on FAA ADS-B, paraphrased CVR, FDR, video, and runway witness mark evidence. Aircraft direction of travel is toward the top of the page. FAA ADS-B data recorded for HI1064 are identified by blue symbols. Green symbols depict NTSB flightpath calculated by integrating FDR accelerometer data.



Figure A14.3: HI1064 accident flight reconstruction looking toward the runway 9 displaced threshold. Ground track reconstruction is based on FAA ADS-B, paraphrased CVR, FDR, video, and runway witness mark evidence. Aircraft direction of travel is toward the top of the page. FAA ADS-B data recorded for HI1064 are identified by blue symbols. Green symbols depict NTSB flightpath calculated by integrating FDR accelerometer data. Distance beyond the runway 9 displaced threshold is annotated in feet.



Figure A14.4: HI1064 accident flight reconstruction 1,000 to 2,000 feet beyond the runway 9 displaced threshold. Ground track reconstruction is based on FAA ADS-B, paraphrased CVR, FDR, video, and runway witness mark evidence. Aircraft direction of travel is toward the top of the page. FAA ADS-B data recorded for HI1064 are identified by blue symbols. Green symbols depict NTSB flightpath calculated by integrating FDR accelerometer data. Distance beyond the runway 9 displaced threshold is annotated in feet.

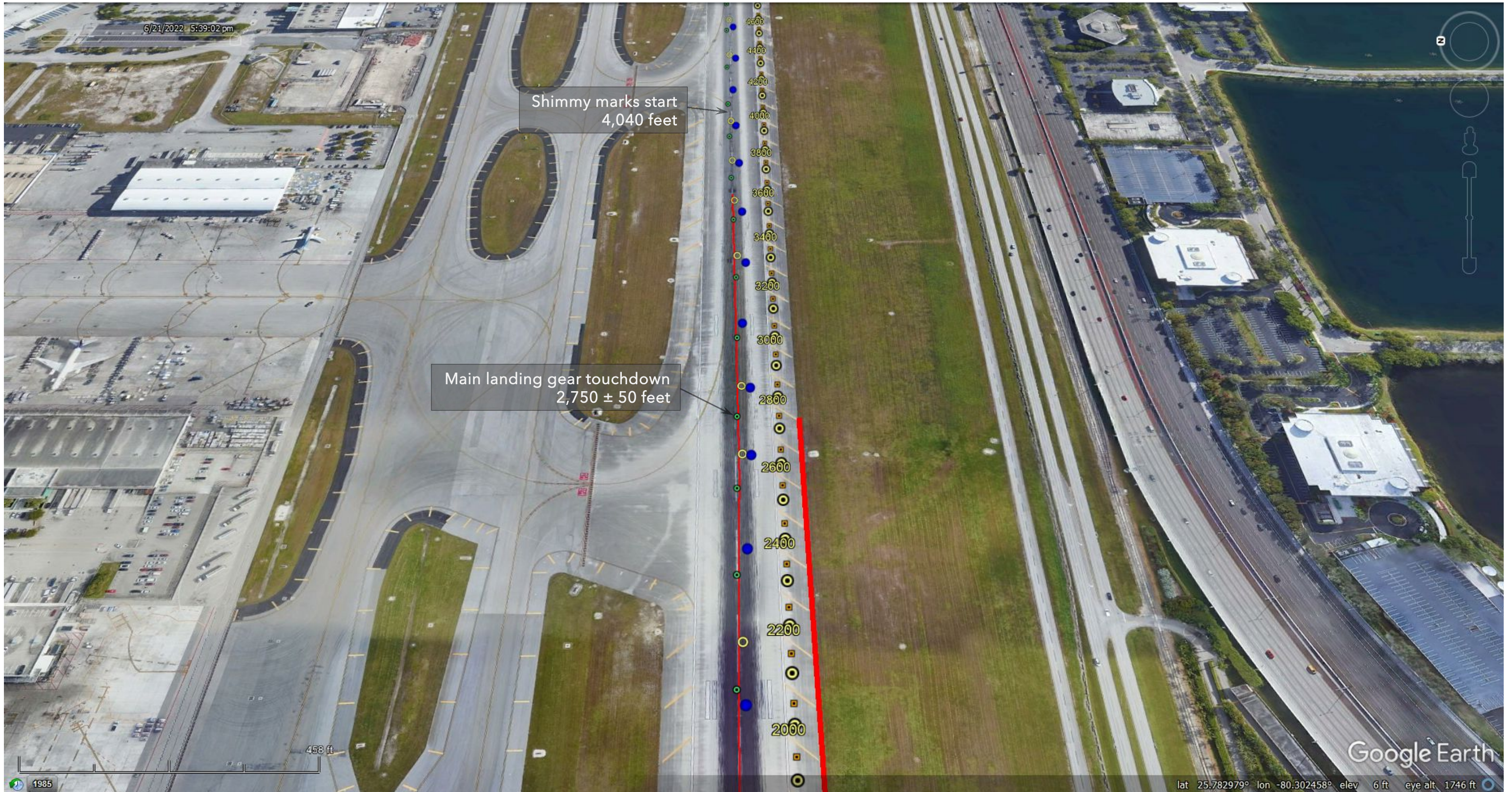

Figure A14.5: HI1064 accident flight reconstruction 2,000 to 3,000 feet beyond the runway 9 displaced threshold. Ground track reconstruction is based on FAA ADS-B, paraphrased CVR, FDR, video, and runway witness mark evidence. Aircraft direction of travel is toward the top of the page. FAA ADS-B data recorded for HI1064 are identified by blue symbols. Green symbols depict NTSB flightpath calculated by integrating FDR accelerometer data. Distance beyond the runway 9 displaced threshold is annotated in feet. Additional text annotations indicate location of main landing gear touchdown and start of left main landing gear shimmy marks.

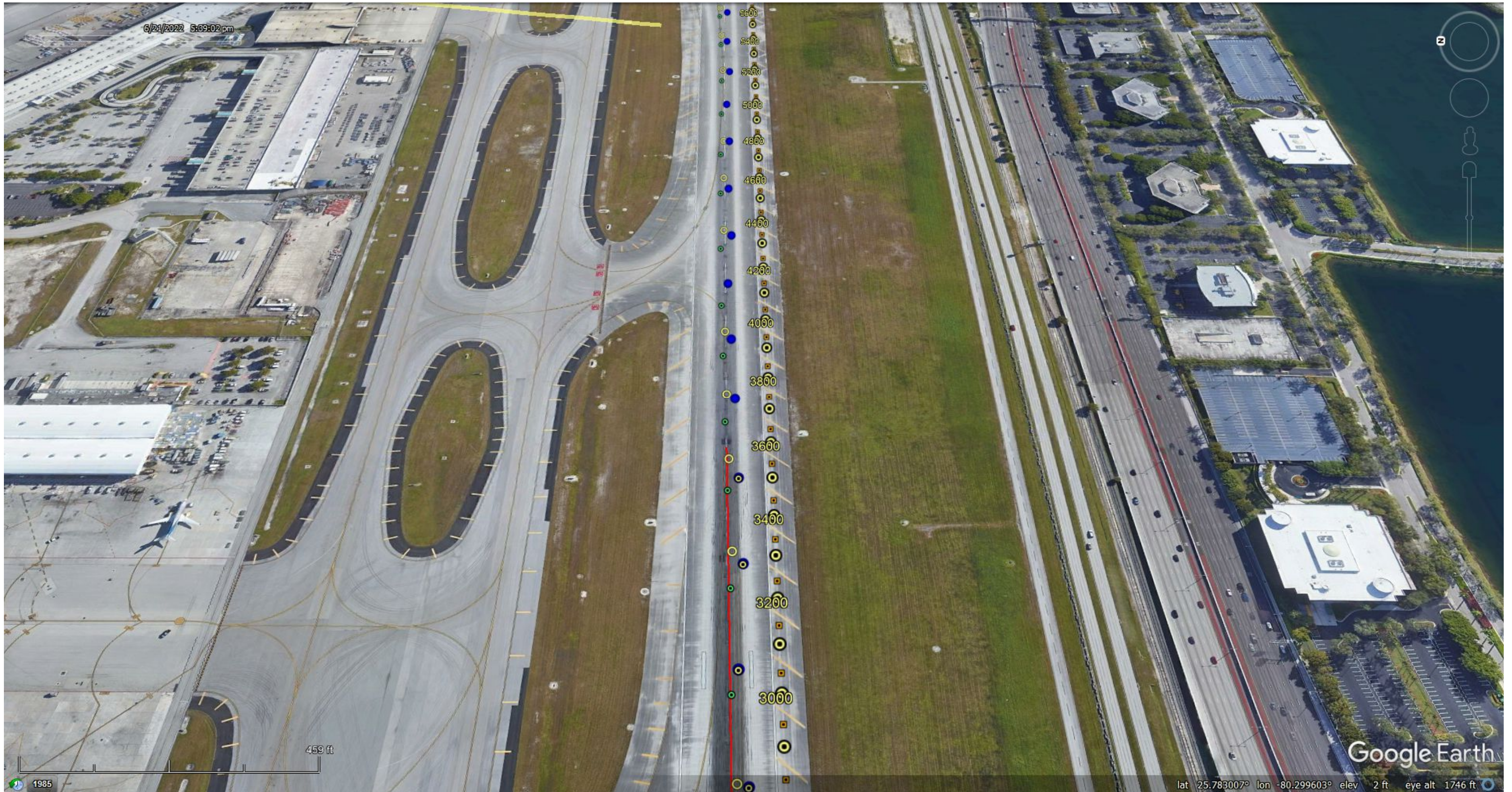

Figure A14.6: HI1064 accident flight reconstruction 3,000 to 4,000 feet beyond the runway 9 displaced threshold. Ground track reconstruction is based on FAA ADS-B, paraphrased CVR, FDR, video, and runway witness mark evidence. Aircraft direction of travel is toward the top of the page. FAA ADS-B data recorded for HI1064 are identified by blue symbols. Green symbols depict NTSB flightpath calculated by integrating FDR accelerometer data. Distance beyond the runway 9 displaced threshold is annotated in feet.

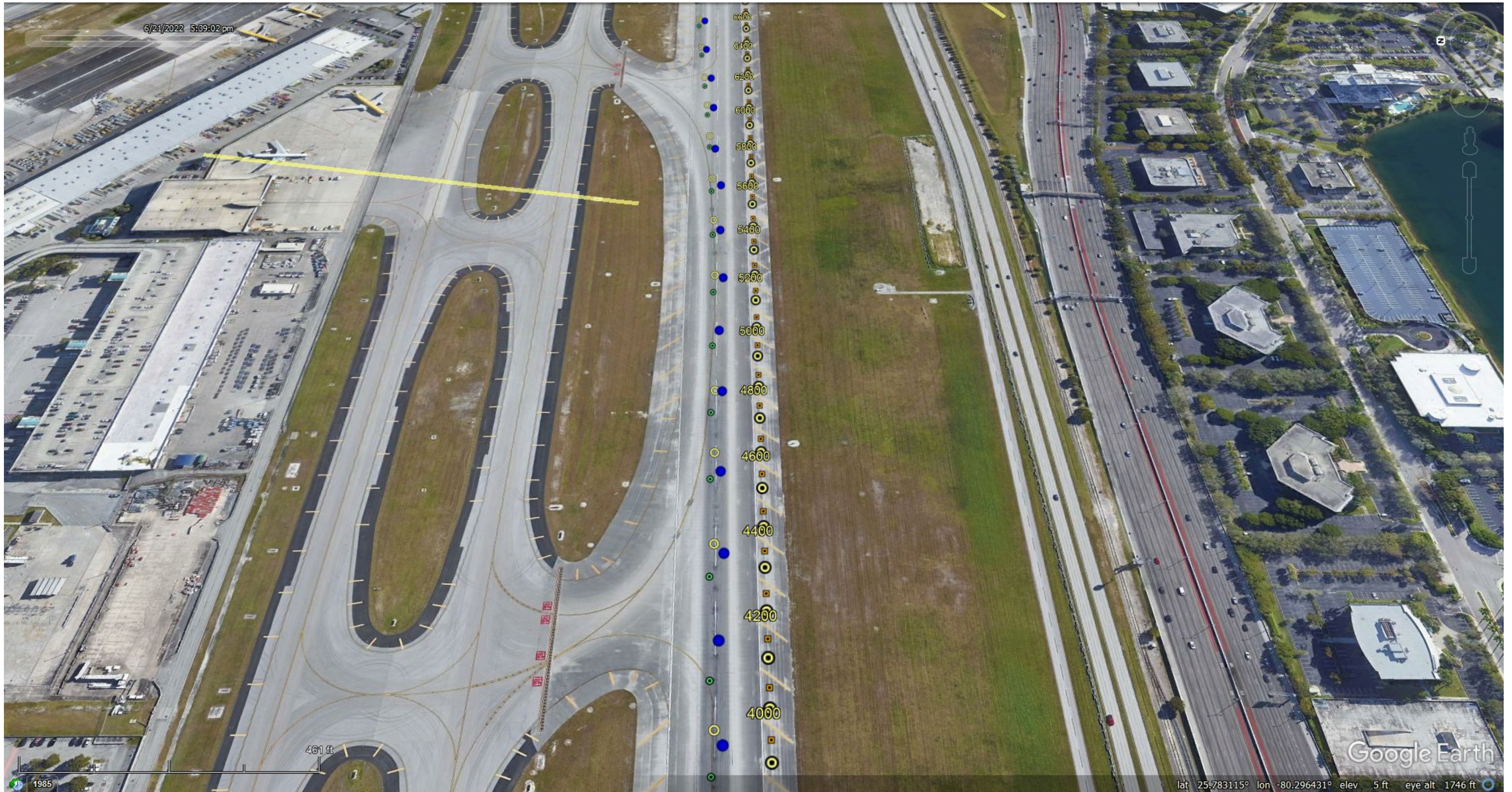

Figure A14.7: HI1064 accident flight reconstruction 4,000 to 5,000 feet beyond the runway 9 displaced threshold. Ground track reconstruction is based on FAA ADS-B, paraphrased CVR, FDR, video, and runway witness mark evidence. Aircraft direction of travel is toward the top of the page. FAA ADS-B data recorded for HI1064 are identified by blue symbols. Green symbols depict NTSB flightpath calculated by integrating FDR accelerometer data. Distance beyond the runway 9 displaced threshold is annotated in feet.

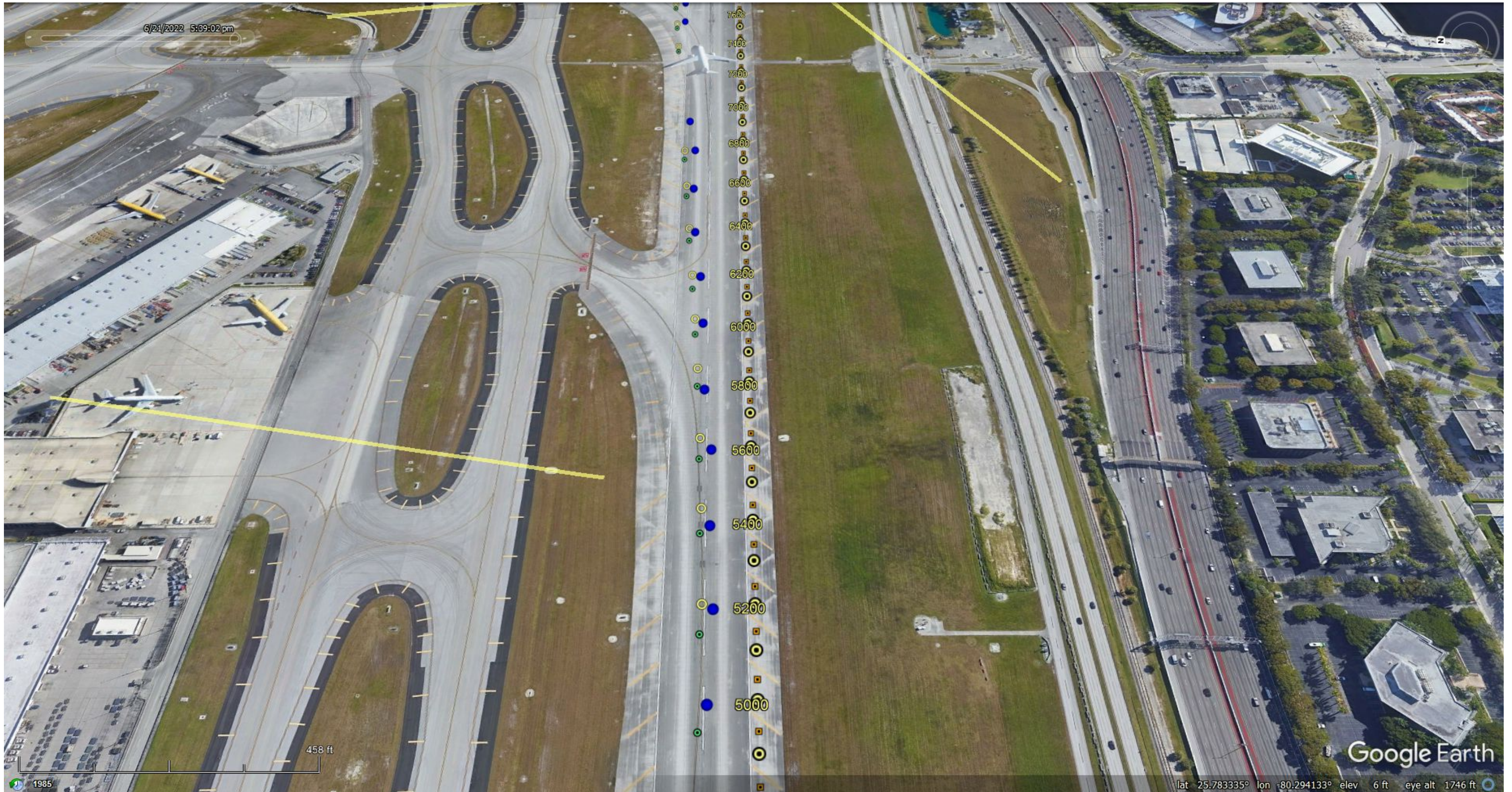

Figure A14.8: HI1064 accident flight reconstruction 5,000 to 6,000 feet beyond the runway 9 displaced threshold. Ground track reconstruction is based on FAA ADS-B, paraphrased CVR, FDR, video, and runway witness mark evidence. Aircraft direction of travel is toward the top of the page. FAA ADS-B data recorded for HI1064 are identified by blue symbols. Green symbols depict NTSB flightpath calculated by integrating FDR accelerometer data. Distance beyond the runway 9 displaced threshold is annotated in feet.

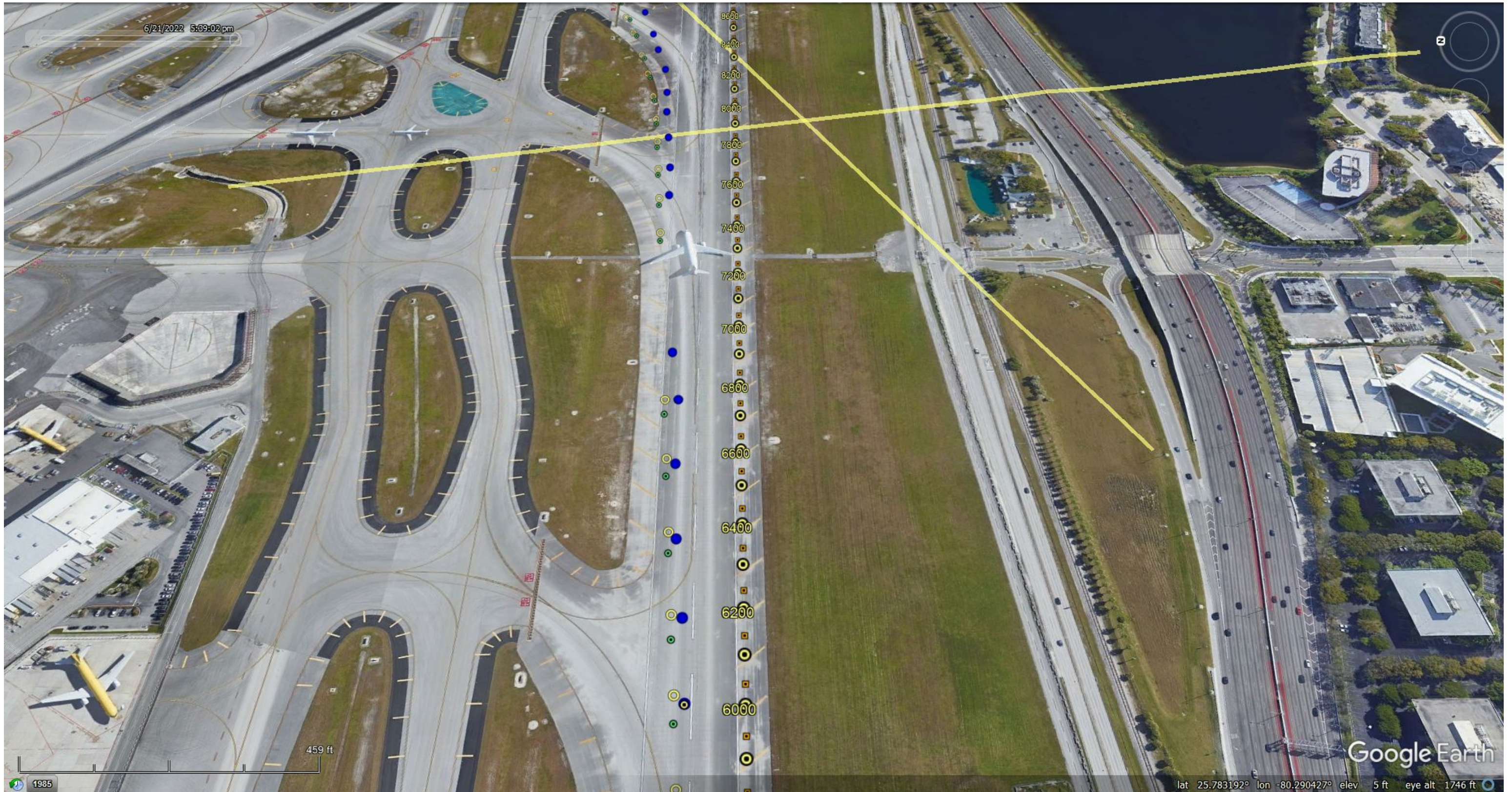

Figure A14.9: HI1064 accident flight reconstruction 6,000 to 7,000 feet beyond the runway 9 displaced threshold. Ground track reconstruction is based on FAA ADS-B, paraphrased CVR, FDR, video, and runway witness mark evidence. Aircraft direction of travel is toward the top of the page. FAA ADS-B data recorded for HI1064 are identified by blue symbols. Green symbols depict NTSB flightpath calculated by integrating FDR accelerometer data. Distance beyond the runway 9 displaced threshold is annotated in feet.

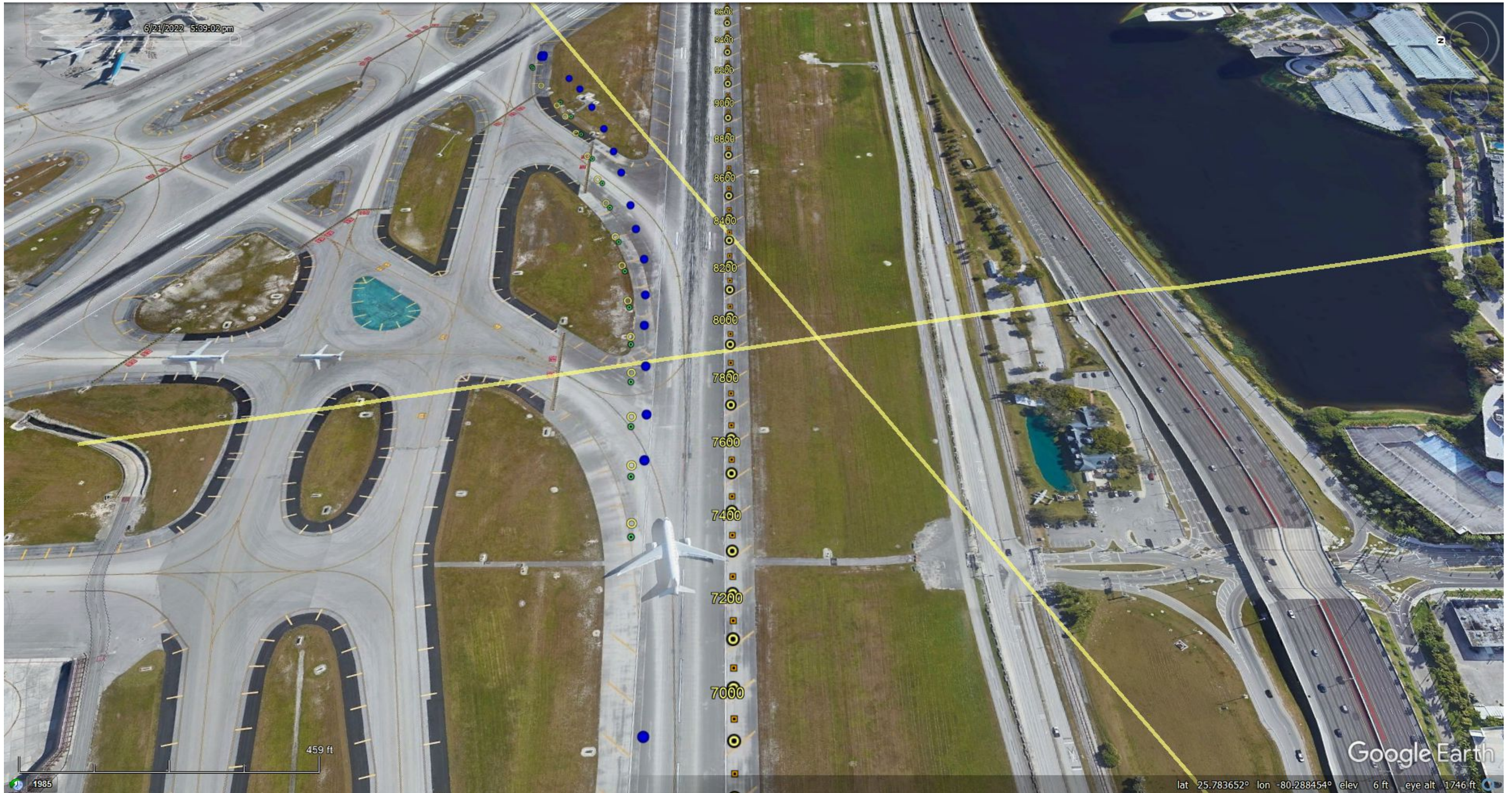

Figure A14.10: HI1064 accident flight reconstruction 7,000 to 8,000 feet beyond the runway 9 displaced threshold. Ground track reconstruction is based on FAA ADS-B, paraphrased CVR, FDR, video, and runway witness mark evidence. Aircraft direction of travel is toward the top of the page. FAA ADS-B data recorded for HI1064 are identified by blue symbols. Green symbols depict NTSB flightpath calculated by integrating FDR accelerometer data. Distance beyond the runway 9 displaced threshold is annotated in feet.



Figure A14.11: HI1064 accident flight reconstruction 8,000 to 9,000 feet beyond the runway 9 displaced threshold. Ground track reconstruction is based on FAA ADS-B, paraphrased CVR, FDR, video, and runway witness mark evidence. Aircraft direction of travel is toward the top of the page. FAA ADS-B data recorded for HI1064 are identified by blue symbols. Green symbols depict NTSB flightpath calculated by integrating FDR accelerometer data. Distance beyond the runway 9 displaced threshold is annotated in feet.

ATTACHMENT 15: LANDING PERFORMANCE (HI1064)

Based on Flight Crew Operations Manual (FCOM)

MD-80 Flight Crew Operations Manual
Estimated Landing Distances (Feet)
Pratt & Whitney JT8D-217/-217A/-217C/-219 Engines
RCC 6 – Dry Runway
Flaps 28/EXT

LDG WT (1000 LB)	AIRPORT PRESSURE ALTITUDE / TEMPERATURE					
	SL	2000 FT	4000 FT	6000 FT	8000 FT	10000 FT
	STD = 15°C	STD = 11°C	STD = 7°C	STD = -3°C	STD = -1°C	STD = -5°C
80	3035	3185	3345	3515	3690	3880
90	3230	3390	3565	3750	3940	4145
100	3425	3600	3785	3980	4185	4405
110	3620	3805	4000	4210	4435	4670
120	3810	4015	4220	4445	4680	4930
130	4010	4220	4440	4675	4920	5190
140	4205	4430	4660	4905	5170	5450
150	4400	4630	4875	5140	5415	5710

Full reverse thrust (1.6 EPR, thrust reduction to reverse idle by 60 KIAS), standard day, no wind, zero slope, maximum manual anti-skid braking, air run distance approximately 1500 feet
 All distances, including corrections shown, have been increased by 15%

Corrections

Temperature FEET PER °C	
BELOW standard day	-12
ABOVE standard day	+35

Valid from STD -20°C to STD +40°C

Slope FEET PER 1% SLOPE	
UPHILL	-104
DOWNHILL	+460

Valid from -2% downhill to +2% uphill

Wind FEET PER KNOT	
HEADWIND	-35
TAILWIND	+127

Valid from -10 knots tailwind to +20 knots headwind

VREF FEET PER KIAS	
ABOVE VREF	+46

Valid from 1 knot to 20 knots above VREF

Reverser	
One Reverser INOP	+40
Two Reversers INOP	+63

Spoilers	
Manual Spoilers	+282