



NATIONAL TRANSPORTATION SAFETY BOARD  
**Investigative Hearing**

Norfolk Southern Railway general merchandise freight train 32N  
derailment with subsequent hazardous material release and fires,  
in East Palestine, Ohio, on February 3, 2023

<b>GROUP</b>	<b>E</b>
<b>EXHIBIT</b>	
20	

Agency / Organization

**Federal Railroad Administration**

Title

**Exhibit 20- Wayside Detector  
Implementation Guide**



U.S. Department of  
Transportation  
Federal Railroad  
Administration

## An Implementation Guide for Wayside Detector Systems

---

Office of Research,  
Development  
and Technology  
Washington, DC 20590



---

May 2019

NOTICE

This document is disseminated under the sponsorship of the Department of Transportation in the interest of information exchange. The United States Government assumes no liability for its contents or use thereof. Any opinions, findings and conclusions, or recommendations expressed in this material do not necessarily reflect the views or policies of the United States Government, nor does mention of trade names, commercial products, or organizations imply endorsement by the United States Government. The United States Government assumes no liability for the content or use of the material contained in this document.

NOTICE

The United States Government does not endorse products or manufacturers. Trade or manufacturers' names appear herein solely because they are considered essential to the objective of this report.

# REPORT DOCUMENTATION PAGE

*Form Approved*  
*OMB No. 0704-0188*

Public reporting burden for this collection of information is estimated to average 1 hour per response, including the time for reviewing instructions, searching existing data sources, gathering and maintaining the data needed, and completing and reviewing the collection of information. Send comments regarding this burden estimate or any other aspect of this collection of information, including suggestions for reducing this burden, to Washington Headquarters Services, Directorate for Information Operations and Reports, 1215 Jefferson Davis Highway, Suite 1204, Arlington, VA 22202-4302, and to the Office of Management and Budget, Paperwork Reduction Project (0704-0188), Washington, DC 20503.

1. AGENCY USE ONLY (Leave blank)		2. REPORT DATE May 2019		3. REPORT TYPE AND DATES COVERED Guide - October 2017	
4. TITLE AND SUBTITLE An Implementation Guide for Wayside Detector Systems				5. FUNDING NUMBERS DTFR53-12-D-0004 Task 29	
6. AUTHOR(S) Monique F. Stewart and Edward Flynn (FRA), Brian Marquis (Volpe), and Sharma & Associates					
7. PERFORMING ORGANIZATION NAME(S) AND ADDRESS(ES) Sharma & Associates, Inc.                      Volpe National Transportation System Center 5810 S Grant Street                              55 Broadway Hinsdale, IL 60521                                Cambridge, MA 02142				8. PERFORMING ORGANIZATION REPORT NUMBER	
9. SPONSORING/MONITORING AGENCY NAME(S) AND ADDRESS(ES) U.S. Department of Transportation Federal Railroad Administration Office of Railroad Policy and Development Office of Research, Development and Technology Washington, DC 20590				10. SPONSORING/MONITORING AGENCY REPORT NUMBER	
11. SUPPLEMENTARY NOTES COR: Monique F. Stewart					
12a. DISTRIBUTION/AVAILABILITY STATEMENT This document is available to the public through the FRA <a href="#">website</a> .				12b. DISTRIBUTION CODE	
13. ABSTRACT (Maximum 200 words) To promote wayside detector system implementation efforts, the Federal Railroad Administration (FRA) has constituted an FRA Future Team - Technology Working Group to progress technology focused research activities to further its safety mission. Under this initiative, FRA partnered with Metro North Railroad (MNR) and Long Island Rail Road (LIRR) to jointly identify opportunities to enhance safety through the analysis of their existing wayside detection systems. This guide includes brief descriptions of various wayside detection technologies, their capabilities and impact on rolling stock performance and operating safety. The requirements for installation site selection, data communication and storage, system thresholds and calibration/maintenance requirements. The guide briefly reviews different wayside detector systems in North America's rail network, including Acoustic Bearing Detectors (ABD) (Trackside Acoustic Detection System [TADS <sup>®</sup> ], Railway Bearing Acoustic Monitor [RailBAM <sup>®</sup> ]), Automatic Cracked Wheel Detector (ACWD), Dragging Equipment Detector (DED), Hot Box Detector (HBD)/Hot Wheel Detector (HWD), Truck Bogie Optical Geometry Inspection (TBOGI), Truck Hunting Detector (THD), Truck Performance Detector (TPD), Weigh-in-Motion Detector (WIM), Wheel Impact Load Detector (WILD), Wheel Profile Measurement System (WPMS), and Wheel Temperature Detector (WTD) systems; while more focus targeted WILD as an example of the best practices in the implementation of wayside detector systems.					
14. SUBJECT TERMS Bearing temperatures, calibration, Dynamic Ratio, DR, Hot Box Detectors, HBD, Truck Hunting Detector, THD, wayside detector systems, wheel flats, Wheel Impact Load Detector, WILD, Wheel Temperature Detector, WTD				15. NUMBER OF PAGES 99	
				16. PRICE CODE	
17. SECURITY CLASSIFICATION OF REPORT Unclassified	18. SECURITY CLASSIFICATION OF THIS PAGE Unclassified	19. SECURITY CLASSIFICATION OF ABSTRACT Unclassified	20. LIMITATION OF ABSTRACT		

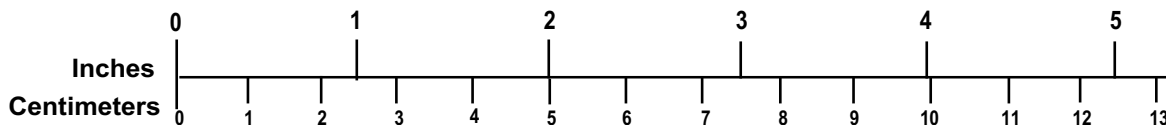
## METRIC/ENGLISH CONVERSION FACTORS

### ENGLISH TO METRIC

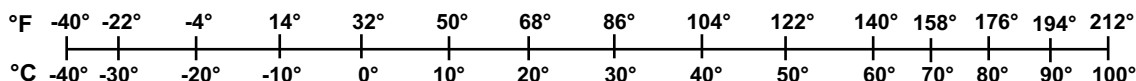
### METRIC TO ENGLISH

<p style="text-align: center;"><b>LENGTH (APPROXIMATE)</b></p> <p>1 inch (in) = 2.5 centimeters (cm)                      1 foot (ft) = 30 centimeters (cm)                      1 yard (yd) = 0.9 meter (m)                      1 mile (mi) = 1.6 kilometers (km)</p>	<p style="text-align: center;"><b>LENGTH (APPROXIMATE)</b></p> <p>1 millimeter (mm) = 0.04 inch (in)                      1 centimeter (cm) = 0.4 inch (in)                      1 meter (m) = 3.3 feet (ft)                      1 meter (m) = 1.1 yards (yd)                      1 kilometer (km) = 0.6 mile (mi)</p>
<p style="text-align: center;"><b>AREA (APPROXIMATE)</b></p> <p>1 square inch (sq in, in<sup>2</sup>) = 6.5 square centimeters (cm<sup>2</sup>)                      1 square foot (sq ft, ft<sup>2</sup>) = 0.09 square meter (m<sup>2</sup>)                      1 square yard (sq yd, yd<sup>2</sup>) = 0.8 square meter (m<sup>2</sup>)                      1 square mile (sq mi, mi<sup>2</sup>) = 2.6 square kilometers (km<sup>2</sup>)                      1 acre = 0.4 hectare (he) = 4,000 square meters (m<sup>2</sup>)</p>	<p style="text-align: center;"><b>AREA (APPROXIMATE)</b></p> <p>1 square centimeter (cm<sup>2</sup>) = 0.16 square inch (sq in, in<sup>2</sup>)                      1 square meter (m<sup>2</sup>) = 1.2 square yards (sq yd, yd<sup>2</sup>)                      1 square kilometer (km<sup>2</sup>) = 0.4 square mile (sq mi, mi<sup>2</sup>)                      10,000 square meters (m<sup>2</sup>) = 1 hectare (ha) = 2.5 acres</p>
<p style="text-align: center;"><b>MASS - WEIGHT (APPROXIMATE)</b></p> <p>1 ounce (oz) = 28 grams (gm)                      1 pound (lb) = 0.45 kilogram (kg)                      1 short ton = 2,000 pounds (lb) = 0.9 tonne (t)</p>	<p style="text-align: center;"><b>MASS - WEIGHT (APPROXIMATE)</b></p> <p>1 gram (gm) = 0.036 ounce (oz)                      1 kilogram (kg) = 2.2 pounds (lb)                      1 tonne (t) = 1,000 kilograms (kg) = 1.1 short tons</p>
<p style="text-align: center;"><b>VOLUME (APPROXIMATE)</b></p> <p>1 teaspoon (tsp) = 5 milliliters (ml)                      1 tablespoon (tbsp) = 15 milliliters (ml)                      1 fluid ounce (fl oz) = 30 milliliters (ml)                      1 cup (c) = 0.24 liter (l)                      1 pint (pt) = 0.47 liter (l)                      1 quart (qt) = 0.96 liter (l)                      1 gallon (gal) = 3.8 liters (l)                      1 cubic foot (cu ft, ft<sup>3</sup>) = 0.03 cubic meter (m<sup>3</sup>)                      1 cubic yard (cu yd, yd<sup>3</sup>) = 0.76 cubic meter (m<sup>3</sup>)</p>	<p style="text-align: center;"><b>VOLUME (APPROXIMATE)</b></p> <p>1 milliliter (ml) = 0.03 fluid ounce (fl oz)                      1 liter (l) = 2.1 pints (pt)                      1 liter (l) = 1.06 quarts (qt)                      1 liter (l) = 0.26 gallon (gal)                      1 cubic meter (m<sup>3</sup>) = 36 cubic feet (cu ft, ft<sup>3</sup>)                      1 cubic meter (m<sup>3</sup>) = 1.3 cubic yards (cu yd, yd<sup>3</sup>)</p>
<p style="text-align: center;"><b>TEMPERATURE (EXACT)</b></p> <p style="text-align: center;"><math>[(x-32)(5/9)]\text{ }^\circ\text{F} = y\text{ }^\circ\text{C}</math></p>	<p style="text-align: center;"><b>TEMPERATURE (EXACT)</b></p> <p style="text-align: center;"><math>[(9/5)y + 32]\text{ }^\circ\text{C} = x\text{ }^\circ\text{F}</math></p>

### QUICK INCH - CENTIMETER LENGTH CONVERSION



### QUICK FAHRENHEIT - CELSIUS TEMPERATURE CONVERSION



For more exact and or other conversion factors, see NIST Miscellaneous Publication 286, Units of Weights and Measures. Price \$2.50 SD Catalog No. C13 10286

Updated 6/17/98

## **Acknowledgements**

---

This effort would not have been possible without the support of Metro-North Railroad and their engineering staff. Their help and cooperation is greatly appreciated.

# Contents

---

Executive Summary .....	1
1. Introduction.....	2
2. Requirements for Implementation of a Wayside Detector System.....	4
2.1 Site Selection Criteria.....	4
2.2 Operating Parameters and Wayside Detector Technology.....	5
2.3 Data Communication, Storage and Sharing .....	6
2.4 Test Requirements for Launching a New System.....	6
2.5 System Thresholds and Performance Monitoring .....	7
2.6 Developing an Action Plan for Triggered Events .....	7
2.7 Calibration and Maintenance Requirements .....	8
2.8 Training .....	8
3. Overview of Various Wayside Detector System Requirements .....	9
3.1 Acoustic Bearing Detector (ABD) .....	9
3.2 Automated Cracked Wheel Detector (ACWD).....	15
3.3 Dragging Equipment Detector (DED).....	18
3.4 Hot Box Detector (HBD) & Hot Wheel Detector (HWD) .....	20
3.5 Truck Bogie Optical Geometry Inspection (TBOGI).....	23
3.6 Truck Hunting Detector (THD).....	26
3.7 Truck Performance Detector (TPD) .....	29
3.8 Weigh-In Motion Detector (WIM).....	32
3.9 Wheel Impact Load Detector (WILD) .....	34
3.10 Wheel Profile Measurement System (WPMS).....	36
3.11 Wheel Temperature Detector (WTD).....	39
4. Case Study: Wheel Impact Load Detector (WILD).....	44
4.1 Functionality, Benefits and System Components.....	44
4.2 Site Selection Criteria of WILD System .....	53
4.3 WILD System Thresholds, and Performance Monitoring.....	57
4.4 Calibration and Maintenance Requirements .....	64
4.5 Examples of Current WILD Experiences and Best Practices .....	65
Appendix A. WPD Calibration Record Requirements .....	79
Appendix B. MNR’s Faults Page with WILD Alert.....	80

Appendix C MNR's Mechanical Maintenance Alert MMA # 292.....	81
Appendix D Cross-sections of HBD and HWD Systems .....	82
5. References.....	83
Acronyms and Abbreviations .....	87



## Illustrations

---

Figure 3-1. TADS <sup>®</sup> system, developed at the TTC [16].....	10
Figure 3-2. An example of RailBAM <sup>®</sup> detector installed on the track [24] .....	13
Figure 3-3. Snapshot of the bearings fault signals generated by RailBAM <sup>®</sup> detector [24].....	13
Figure 3-4. A cup fault (left) and cone fault (right) identified by RailBAM <sup>®</sup> detectors .....	14
Figure 3-5. Schematic plan of track structure (wide gauge, guard-rail) for ACWD site [30] .....	15
Figure 3-6. An ACWD installed at the TTC by Tycho [30] (top), ACWD detector in the TTC is spraying water couplant to conduct ultrasonic inspection on the wheels (bottom) [32] .....	16
Figure 3-7. Schematic plan of ACWD site developed by Nordco [26].....	16
Figure 3-8. Another type of wheel crack detector deployed in Europe using Electromagnetic Acoustic Transducers [9].....	17
Figure 3-9. An example of a Dragging Equipment Detector (DED) [3] .....	19
Figure 3-10. A dragging component detected by DED system [10].....	19
Figure 3-11. An example of HBD system (outer detectors) combined with HWD system (inner detectors) [41].....	21
Figure 3-12. An example of a hot journal flagged by an HBD detector with multi-scan system (eight channels) [43].....	21
Figure 3-13. TBOGI system to identify poorly performing trucks [8] .....	24
Figure 3-14. Triple-box configuration of a TBOGI-HD system [47].....	24
Figure 3-15. Different types of geometrical errors of trucks which can be detected by TBOGI-HD [46].....	25
Figure 3-16. THD system based on strain-gage detectors [6] .....	27
Figure 3-17. A sample history of THD alerts and info on a given rail car monitored through InteRRIS <sup>®</sup> - EHMS system [29].....	28
Figure 3-18. Force-based TPD cribs and detectors laid-out along a given S-curve [53].....	30
Figure 3-19. Flange and longitudinal creep forces acting against the rotational resistance between truck and carbody [51] .....	31
Figure 3-20. WIM strain gages attached to the web of the rail on an instrumented track [9] .....	33
Figure 3-21. Strain gages of WILD system attached to the inner sides of rail web [65].....	35
Figure 3-22. An example of WPMS system with laser triangulation and matrix camera [9].....	37
Figure 3-23. Left: wheel profile measurements captured by WPMS; Right: brake pad measurements by a WPMS detector [71] .....	37
Figure 3-24. A comparison between current wheel profile produced by WPMS (blue line) and its respective theoretical profile (red line) [71].....	38

Figure 3-25. An example of WTD for brake effective tests (left); (right) Wheel temperature variation on a train indicating braking condition [8].....	40
Figure 3-26. Wheel temperature on different cars of a test train in “Non-braking” status using WTD [71] .....	41
Figure 3-27. Wheel temperature on different cars of a test train in “Braking” status using WTD [71] .....	42
Figure 4-1. Relationship between static loads and peak loads collected by a WILD system in a Class I railroad network, classified for different types of rolling stock [75] .....	46
Figure 4-2. Different components of a sample WILD system, based on strain gage technology [2] .....	48
Figure 4-3. An example of WILD site components developed by L.B. Foster [59] .....	48
Figure 4-4. Architecture of WheelCheX <sup>®</sup> as an example of an available WILD system.....	49
Figure 4-5. Voestalpine’s WILD system using optic sensors underneath of the rails [10] .....	50
Figure 4-6. An example of wheel tread irregularity detection concept of MERMEC’s WILD system using accelerometers and strain gages [9].....	50
Figure 4-7. Comparison of impact loads on wood and concrete ties at 40 mph, 100-ton cars, and machined flats [69] (recreated chart).....	54
Figure 4-8. Impact load scatter (36-inch diameter out-of-round wheel, single 140 mm divot, 100-ton loaded car [69] (recreated chart) .....	56
Figure 4-9. Impact load statistics (36-inch diameter out-of-round wheel, single 140 mm divot, 100-ton loaded car [69] (recreated chart) .....	56
Figure 4-10. Rate of WILD readings (per 1,000 wheels) and seasonal effect in North America during 2003–2013 [8] .....	61
Figure 4-11. Impact of WILD installations on track cause related derailments [7] .....	63
Figure 4-12. Interdepartmental data flow for MNR's WILD system [1] .....	68
Figure 4-13. Follow-up actions for a WILD alert at MNR [1] .....	69
Figure 4-14. Information/action sequence of WILD system at MNR [1].....	70
Figure 4-15. An example of maximum loads time history of a 100-ton 4-axle car wheels—empty and loaded conditions during 2004–2012 [7].....	71
Figure 4-16. An example of AMS GUI details for a selected MNR train [1] .....	72
Figure 4-17. “AAR Condemnable” wheels for the US WILD systems (monthly count) [7] .....	73
Figure 4-18. Seasonal trend on number of flagged wheels by MNR’s WILD system during the fall season (particularly November) of 2010–2015.....	74
Figure 4-19. Comparison between number of flagged wheels by WILD and number of truing due to “flat and shell spot” irregularities, collected for the given car series of MNR during 2010–2015 .....	75

Figure 4-20. Histogram of flagged wheels by WILD system for a given car of MNR commuter RR during 2010-2015 ..... 76

Figure 4-21. Mean load distribution of two selected cars (#XXXX on left and #YYYY on right) based on WILD data collected during 2010–2015 ..... 78

## Tables

---

Table 3-1. Summary of all wayside detector systems covered in this guide .....	9
Table 3-2. Summary of main requirements and specifications of TADS <sup>®</sup> (ABD) system.....	12
Table 3-3. Summary of main requirements and specifications of RailBAM <sup>®</sup> (ABD) system .....	15
Table 3-4. Summary of main requirements and specifications of ACWD system.....	18
Table 3-5. Summary of main requirements and specifications of DE .....	20
Table 3-6. Summary of main requirements and specifications of HBD and HWD systems.....	23
Table 3-7. Summary of main requirements and specifications of TBOGI system.....	26
Table 3-8. Summary of main requirements and specifications of THD system.....	29
Table 3-9. Summary of main requirements and specifications of TPD system.....	32
Table 3-10. Summary of main requirements and specifications of WIM system .....	34
Table 3-11. Summary of main requirements and specifications of WILD system.....	36
Table 3-12. Summary of main requirements and specifications of WPMS system .....	39
Table 3-13. Wheel temperature standard deviation associated with body rigging or hand brake [51] .....	42
Table 3-14. Summary of main requirements and specifications of WTD system.....	43
Table 4-1. List of available WILD suppliers around the world.....	49
Table 4-2. WILD system thresholds to maintain the reliability and precision level of the collected data .....	51
Table 4-3. An example of measured and calculated wheel impacts at various speeds (source: CP) [78] .....	55
Table 4-4. WILD indices for freight service [7].....	57
Table 4-5. MNR’s decision table for “Actionable” WILD data [1] .....	58
Table 4-6. History of “Truing” and “Change-out” actions on the wheels of the same given car of MNR commuter railroad during 2010–2015.....	77

## Executive Summary

---

The Federal Railroad Administration's (FRA) goal in supporting wayside detector system implementation efforts is to promote improved safety. This goal can be achieved by monitoring equipment performance through the appropriate and optimal application of automated inspection technologies to monitor railroad rolling stock equipment performance and identify maintenance needs proactively. The wayside detector technologies not only monitor rolling stock equipment performance, the associated data from the wayside detector technologies can be used to predict the future failures which may be prevented.

In 2015, FRA constituted the FRA Future Team - Technology Working Group (herein referred to as the FRA Future Team) with the intent of progressing selected technology related research activities that can further its safety mission.

Under this initiative, FRA partnered with Metro-North Railroad (MNR) and Long Island Rail Road (LIRR) to jointly identify opportunities to enhance safety operations through the analysis of existing wayside detection systems and related operational procedures. FRA's Office of Research, Development and Technology (RD&T) is also interested in extending such efforts with other railroads in the future. Based on the lessons learned in the cooperative project with MNR and general industry efforts in pursuing implementation of various wayside technologies, the FRA Future Team has focused on developing this implementation guide which can help railroads implement wayside detector systems.

This guide includes brief descriptions of various wayside detection technologies, which are available in North America's rail network to inspect and monitor rolling stock health status, particularly in terms of wheel and truck related irregularities. It provides brief descriptions of different recommendations for implementing a new wayside detector system including: site selection criteria, data communication, test requirements, system thresholds, action plan for triggered events, and calibration/maintenance requirements.

The guide briefly described and reviewed various wayside detector systems including Acoustic Bearing Detector (ABD), Trackage Acoustic Detection System (TADS<sup>®</sup>), Railway Bearing Acoustic Monitor (RailBAM<sup>®</sup>), Automated Cracked Wheel Detector (ACWD), Dragging Equipment Detector (DED), Hot Box Detector (HBD), Hot Wheel Detector (HWD), Truck Bogie Optical Geometry Inspection (TBOGI), Truck Hunting Detector (THD), Truck Performance Detector (TPD), Weigh-In Motion Detector (WIM), Wheel Impact Load Detector (WILD), Wheel Profile Measurement System (WPMS), and Wheel Temperature Detector (WTD) systems. Each section includes a table of criteria which summarizes primary specifications and requirements of respective systems.

As WILD is one of the most widely deployed systems, this guide contains a detailed discussion on its functionality and benefits, site selection criteria, system thresholds and preference monitoring, calibration and maintenance requirements, and some examples of WILD practices experienced by selected North American railroads.

# 1. Introduction

---

Over the years, the Federal Railroad Administration (FRA) funded efforts to develop and implement wayside detection systems for equipment performance monitoring, and, in some cases, to promote and support deployment of detectors. These detectors are designed to reduce risk in railroad operations by identifying poorly performing equipment before accidents occur.

In 2015, FRA constituted the FRA Future Team - Technology Working Group (herein referred to as the FRA Future Team) to advance selected technology related research activities that can further its safety mission.

Under this initiative, FRA partnered with Metro-North Railroad (MNR) and Long Island Rail Road (LIRR), and jointly identified opportunities to enhance safety operations through the analysis of existing wayside detection systems and related operational procedures. FRA's Office of Railroad, Development and Technology (RD&T) is also interested in extending such efforts to other railroads in future.

Past efforts in using wayside detector devices and systems in support of mandated visual inspections were stymied by the general lack of understanding and definition of the procedures associated with the calibration and maintenance of these systems, as well as issues surrounding the definition of maintenance limits, exception limits, data analysis procedures, etc.

To address these concerns, Sharma & Associates, Inc. (SA) was tasked by FRA to conduct a review of the MNR's wayside systems, particularly focusing on Wheel Impact Load Detector (WILD) implementation as integrated into operations and maintenance practices by MNR. SA determined that MNR implemented well-thought out and integrated wayside detector systems with the ability to enhance MNR's safety performance. The alarm criteria and resulting actions have allowed MNR to effectively monitor and detect changes in equipment performance, and take appropriate preventive measures to keep the rolling stock safely.

As a part of this project, SA was tasked with developing a Wayside System Implementation Guide that could be used by other railroads that plan to install and implement wayside detection systems. These systems are useful for fleet performance monitoring, improving operational procedures, effective maintenance practices, and enhanced safety.

The contents of this guide are organized as follows:

- [Section 2](#) provides a brief description of various major requirements for implementing a wayside detector system along a given rail corridor. This section covers various criteria and specifications including: site selection criteria, operating environment, data communication and storage, test requirements for launching a new system, system thresholds, action plan for triggered events, and calibration and maintenance requirements.
- [Section 3](#) briefly reviews wayside detector systems that are currently in use in North America's rail network to inspect and monitor rolling stock health status, particularly in terms of wheel and truck related irregularities. This section covers various detector systems including: Acoustic Bearing Detector (ABD), Trackside Acoustic Detection System (TADS<sup>®</sup>), Railway Bearing Acoustic Monitor (RailBAM<sup>®</sup>), Automated Cracked Wheel Detector (ACWD), Dragging Equipment Detector (DED), Hot Box Detector (HBD), Hot Wheel Detector (HWD), Truck Bogie Optical Geometry Inspection

(TBOGI), Truck Hunting Detector (THD), Truck Performance Detector (TPD), Weigh-In Motion Detector (WIM), Wheel Impact Load Detector (WILD), Wheel Profile Measurement System (WPMS) also known as Wheel Profile Detector (WPD), and Wheel Temperature Detector (WTD) systems. Each section includes a table of criteria which summarizes primary specifications and requirements of respective systems.

- [Section 4](#) provides extensive details on the wheel impact load detector (WILD) system, a technology widely deployed across the national rail network, including the users experience and the best practices reported. WILD system characteristics detailed in this section, include: system functionality and benefits, site selection criteria, system thresholds and preference monitoring, calibration and maintenance requirements, and some examples of WILD practices experienced by selected North American railroads.
- [Appendices A](#) through [D](#) provides some additional information regarding WPD, WILD, HBD and HWD systems.

This guide will be updated as additional information on the wayside systems from the participating railroads becomes available.

## **2. Requirements for Implementation of a Wayside Detector System**

There are several varieties of wayside detectors in the rail industry that are being deployed by railroads to monitor equipment performance and identify rolling stock defects and irregularities. These detectors are designed to reduce risk in railroad operations by identifying poorly performing equipment before accidents occur. The Association of American Railroads (AAR) developed an Equipment Health Management System (EHMS) to house the data from a majority of detectors. The AAR and the freight industry developed the criteria for their integration.

There are several criteria and features for installing a new wayside detector system that should be considered to increase the likelihood of operating the detectors with higher productivity and efficiency. This section reviews the primary requirements of wayside detector systems intended for implementation along a given rail corridor. More details about functionality, benefits, and particular requirements and characteristics of each wayside detector system are described in [Section 3](#).

### **2.1 Site Selection Criteria**

The location of a new wayside detector system should be carefully evaluated and selected based on the following criteria and respective system characteristics recommended by the vendor or consultant firm [1, 2].

#### **2.1.1 Track Characteristics**

Track characteristics such as track quality and geometric specifications can be critical in selecting the location of a new wayside detector system. Some of the detectors such as WILD, TBOGI, and TPD systems may need specific track requirements and criteria to operate effectively, such as the following:

- **Track Components:** Examples include only tracks with concrete crossties or ballasted tracks, or welded rails, or a specific type of rail and fastening system.
- **Track Geometry Requirements:** Examples include no horizontal curvature, or significant grades.
- **Track Structure Requirements:** Examples include that they may not be installed in a tunnel, on a bridge, along a grade-crossing, or within the boundaries of switches, unless specified and permitted by the manufacturer.
- **Ride Quality:** Some of the wayside detector systems may need to be installed along locations to minimize the ambient noise level, vibration, etc., which may affect the wayside system sensors.

#### **2.1.2 Traffic and Speed Coverage**

A wayside detector system should be located so that it has as much of the traffic flow past it as possible to derive the maximum benefit from the installation. Some wayside detector systems including WILD, WIM, HBD, etc. are able to capture traffic in both directions, while other systems may be limited to only one direction due to operating practices, which may require dual installations. The decision-making process for locating a system should also consider:



- Operational speed of the rail vehicles passing along the given location
- Speed limit of the given track segment
- Minimum and maximum speed thresholds of the wayside detector

### **2.1.3 Location Accessibility and Maintenance Features**

The prospective location of a wayside detector system should allow suitable access for conducting inspection and maintenance activities. For detector systems that need immediate action (follow-up inspection or repair action), there should be a rail facility located within a reasonable distance from the proposed location of the wayside detector site so that a train crew can quickly stop a train to inspect or set out the cars flagged by the wayside system. This is highly dependent on the network layout and type of railroad service.

Other accessibility criteria, such as easy access to communication and power, security, right of way aspects, and the history of neighboring interaction with railroad assets, should be also considered. Also, for some of the wayside detectors such as HBD and WILD, it is typically recommended to install these systems outside of train stop locations (e.g., away from yards, sidings, stations, or hump yard boundaries) that tend to create high variability in operating speeds. However, detectors such as WIM, or DED systems, which have less dependency on speed, can be installed within the yard and station territories.

### **2.1.4 Other Criteria**

Other criteria, such as avoiding interference with already existing equipment and facilities should also be considered when selecting a location for a new wayside detector system. It may be possible to integrate the proposed wayside detector with existing wayside systems (such as WILD and HBD, or HBD and HWD systems), so this situation should also be considered.

Also, the location of a new wayside detector system should take into consideration any limitations and requirements recommended by the vendor in terms of installation, maintenance, and inspection to minimize rail traffic disruptions.

## **2.2 Operating Parameters and Wayside Detector Technology**

The type of a new wayside detector system should be selected such that it can meet the expected objectives of the new system on the rail corridor considering the operating parameters which are practiced on that section. Several factors should be considered including, but not limited to, the nature of the railroad (passenger, freight or commuter), operating rules, special instructions, train frequency, carload volumes, and track specifications. For instance, the precision and resolution level of WILD readings might be more important to consider for potential installation on a commuter or a light rail system, in comparison to a heavy freight and intercity passenger corridor with much higher axle loads.

The required time for replacing and repairing the components of a new wayside detector system would be an important parameter for a congested rail corridor with tight train schedules, since a long procedure for wayside detector maintenance may cause more delays and service interruptions for congested corridors.

Some wayside detector systems may not be applicable for certain rail operating parameters. For instance, the DED system is typically installed on the segments of a corridor with mixed

passenger and freight train operation practices [3]. WIM and THD, on the other hand, are typically installed in corridors with more freight rail operations [4, 5, 6].

### **2.3 Data Communication, Storage and Sharing**

The wayside detector system can collect a massive amount of data every day, based on the volume of traffic and the type of detection system. This data should be regularly collected, processed, analyzed, and reported to a decision center (train crews, dispatchers or other authorized crews). Also, it should be clarified what type of data and when the processed data should be archived and restored for any further investigation. Such procedures should be designed well in advance and may need to be integrated with other local or interchangeable database management systems, such as the InteRRIS<sup>®</sup> system,<sup>1</sup> EHMS, UMLER<sup>®</sup>, or other similar systems.

There are varieties of communication means developed for different wayside detector systems, such as [7, 8, 9, 10]:

- Global Positioning System (GPS)-based communication between the on-site equipment and other remote equipment and office staff
- Optical fiber for faster and higher communication capacities
- Hard wired high-speed modems and/or wireless cellular connections for intranet and internet based communication features
- Radio communication between system components and authorized railroad personnel

Also, note that automatic email messages, alerts, radio transmissions, and shop orders can be created and sent to various departments, depending on the type of wayside detector and urgency level of the alert. Reliable communication between different wayside detectors, other remote equipment and staff is needed.

Based on the internal communication guidelines, data can be shared with information technology, signaling, mechanical, operations, and track and maintenance groups. In case of hosting other railroads traffic over a given wayside detector (freight, passenger, or commuter); there should be an agreement between the parties on how and what detector data will be shared.

### **2.4 Test Requirements for Launching a New System**

All components and features of a new wayside detector system should be tested before turning the system on for normal operations. The pass-fail criteria or thresholds of each test (e.g., expected values) and the instructions for conducting the tests should be established and communicated to the respective staff.

The components and features tested may include, but are not necessarily limited to:

- Trackside detectors and sensors such as rail sensors, cables and connectors, power supply, train identification equipment

---

<sup>1</sup> A central health monitoring system which shares nine different wayside detector systems including WILD between all authorized railroaders such as Class I and rail car manufacturers.

- Wayside signaling bungalows/huts, acting as a control room, containing computers, power relays, battery backups, and/or communication equipment, configured with analytical programs, connectivity tools and diagnostic algorithms
- System features and functionality such as train detection, train configuration (car, wheelset and axle levels), train or vehicle speed, train weight, axle loads, and temperature

All results of component testing should be recorded and maintained for potential future reference [1, 11]. If the system has a self-diagnosis feature, it does not dismiss the need for verifying the given feature of the wayside detector system before engaging in daily operations. The system should store the results of such a self-diagnosis.

#### **2.4.1 Successful Tests**

There is no further test required for a system component when it successfully passes its test, unless it is recommended by the system vendor. However, the system maintenance procedure should be followed according to the vendor requirements even if the initial test (or follow up test if required by the vendor) is successfully passed.

#### **2.4.2 Handling Non-Successful Test**

Any fault discovered during the test procedure should be recorded and diagnosed using the Fault Diagnostic Procedure (FDP), as recommended by the system vendor [1]. If the FDP does not resolve the issue and the suspicious component or feature is not properly functional, then this issue should be referred to the vendor to be properly addressed. The system should not be operated without re-applying the failed test and obtaining a pass result after conducting the appropriate action recommended by the vendor.

### **2.5 System Thresholds and Performance Monitoring**

The data collected from the wayside detector system should be analyzed based on the thresholds and decision criteria which have been recommended by the manufacturer. The system thresholds should be defined in a way that it meets the FRA and AAR requirements.

Different performance indices are typically defined depending on the type of wayside detector, including temperature based, load based, dimension based, laser or acoustic pre-determined based indices.

The validity of thresholds selected for a detector system should be assessed to not only meet the minimum safety requirements, but should also accommodate the capacity of the inspection and maintenance facilities to repair the equipment flagged by the system. It is recommended to closely monitor the performance of the wayside detector system for some period to evaluate the impact of the system thresholds on the other parts of operations. More details about the specific thresholds of each wayside detector system are provided in [Section 3](#).

### **2.6 Developing an Action Plan for Triggered Events**

Once a wayside detector system flags rail equipment (wheel, axle, journal, truck or car) with measured values outside the acceptable threshold indices, there should be an appropriate action to address the triggered incident recorded by the wayside detector. The respective actions can be generated either automatically by the detector software or it can be developed by the respective

authorized parties (rail operator, car owner, etc.) as a result of further analysis. The analysis should be reported in near real time for those irregularities and alarms which can endanger the safety of rail vehicle operations. Some of the actions developed by wayside detector systems are as follows:

- Stop operating the rail equipment immediately until further inspection is conducted
- Train speed reduction until further inspection is conducted
- Inspect the rail equipment as soon as practicable
- Check the flagged component during the next scheduled inspection or maintenance event

More details about follow-up actions for each wayside detector system are explained in the next section.

## **2.7 Calibration and Maintenance Requirements**

After launching a new wayside detector system, it should be calibrated and regularly maintained based on Original Equipment Manufacturer (OEM) requirements and recommendations.

The calibration requirements and frequency of the calibration is typically based on the type and functionality of the wayside detector system as well as the operating parameters. The calibration procedure may need to be facilitated by additional programming, macros, or specific tools that the manufacturer provided in advance. Also, some of the wayside detector systems are designed to be automatically calibrated without using any extra procedure or a manually performed calibration [4, 9, 10].

The calibration may need to be checked often to protect against conditions that can affect the outcomes of wayside detector systems, such as environmental impacts, new types of cars passing by the detector, track conditions, and aging of instrumented components. If the calibration accuracy falls outside the accepted limits, then a re-calibration or maintenance action should be conducted on the wayside detectors following the respective regulations of the rail operator [12].

Monitoring and analyzing different aspects of collected data by wayside detector systems can also help respective authorities decide whether the calibration procedure needs to be adjusted to improve the performance and productivity of wayside detectors or not. If the overall monitoring and trending analysis of the detector system demonstrates an acceptable level of productivity and effectiveness, then it can be concluded that the current calibration procedure was properly designed. Otherwise, it is recommended to review the calibration procedure and modify the sensitivity and decision trigger algorithm or replace certain parts of the sensors, if needed.

## **2.8 Training**

To realize the full potential of the wayside detector system, the personnel who interact with it, directly or indirectly, should be trained on how to install, function, inspect or maintain the components of the system depending on the role and responsibilities. Generally, personnel from signaling and communication, information technology (IT), mechanical, operations, and track (infrastructure) should be engaged early in the planning and implementation stages. The training framework and its contents should be developed based on the type of the wayside detector and the railroad organization structure.

### 3. Overview of Various Wayside Detector System Requirements

This section reviews the most common wayside detector systems in North America’s rail network that are used to inspect and monitor rolling stock health status, particularly in terms of the wheel and truck related defects and irregularities. The review of each wayside detector includes a table of criteria that presents primary specifications and requirements of the respective system. Table 3-1 summarizes all wayside detector systems which were covered in this guide.

**Table 3-1. Summary of all wayside detector systems covered in this guide**

Wayside detector	Functionality	No. of available detectors
ABD (TADS®)	Detecting the internal defects of wheel bearings long before they fail, using acoustic technology	19 (Freight: 19, Passenger: 0, Commuter: 0)
ABD (RailBAM®)		20 (Freight: 20, Passenger: 0, Commuter: 0)
ACWD	Identify wheel flange cracks and internal defects by submerging the wheel tread through water	2 (Freight: 2, Passenger: 0, Commuter: 0)
DED	Detecting the components of rolling stock that are loose under moving trains	More than 1,000 DEDs (mostly along freight rail network)
HBD	Detecting the wheel bearings defects, using an infrared thermal detection system	More than 6,000 HBDs (mostly along freight rail network)
HWD	Detecting hot wheels due to locked or sticking brake shoes, using an infrared thermal detection system	NA (most of HWDs are integrated with HBD systems)
TBOGI	Measuring the performance of car axles and wheel suspension using a laser-based technology combined with a high-speed camera along a tangent section of track	28 (Freight: 28, Passenger: 0, Commuter: 0)
THD	Evaluating truck hunting behavior (measuring hunting index) using strain-gages or laser-based technologies	94 (Freight: 90, Passenger: 4, Commuter: 0)
TPD	Evaluating the suspension performance of trucks along a S curve section of track (strain-gages or laser-based)	14 (Freight: 11, Passenger: 0, Commuter: 3)
WIM	Measuring the overload, side-to-side imbalance, or end-to-end imbalance condition of the cars	NA (mostly along freight rail network)
WILD	Detecting the wheel defects (e.g., flat, shell, thermal cracks) by analyzing the wheel impact loads	185 (Freight: 172, Passenger: 9, Commuter: 4)
WPMS	Measuring wheel profile defects (e.g., flange height and thickness, rim thickness), using laser and high-speed camera)	15 (mostly along freight rail network)
WTD	Detecting hot wheels (due to locked or sticking brake shoes) and cold wheels (inoperative brake system) using infrared scanning technology	More than 700 WTDs (mostly along freight rail network)

#### 3.1 Acoustic Bearing Detector (ABD)

The acoustic bearing detector system is based on an analysis of acoustic signature generated by various bearing components of a bearing namely, cone, cup and rollers [13, 14]. A bearing fault excites structural response of the bearing components that radiate sound with signature characteristics of the bearing fault. By analyzing these sounds, the system can separate out precisely which bearing component has the fault present. Further, the analysis also generates a

severity index for these faults allowing monitoring of the bearing if a maintenance or replacement is warranted.

There are two types of ABD system available in the North America's rail network, known as TADS<sup>®</sup> and RailBAM<sup>®</sup>. More details on each specific system are provided in the following sections.

### **3.1.1 Trackside Acoustic Detection System (TADS<sup>®</sup>)**

As shown in [Figure 3-1](#), the TADS<sup>®</sup> system consists of three sets of microphone arrays that span approximately 25 feet along the track. The TADS<sup>®</sup> arrays are positioned on both sides of track, at the approximate height of railcar bearings. The system should be installed on tangent track, where the minimum speed of passing train is 40 mph. Also, the system should not be located where trains may need to apply brakes, to reduce the interference associated with train noise that may cause false positives [15].



**Figure 3-1. TADS<sup>®</sup> system, developed at the TTC [16]**

According to the Transportation Technology Center (TTC), the TADS<sup>®</sup> system can cover both tapered roller bearings (AAR and metric sizes) and spherical roller bearings. The system is capable of processing the following items on bearings [16]:

- High risk defects (unusual low frequency sound sometime called “growling”)
- Cup defects (spalling, brinelling, water etch)
- Cone defects (spalling, brinelling, water etch)
- Roller defects (spalling, brinelling, water etch, seams), and
- Loose cones

In most cases these potential defects and irregularities can be detected in a single pass between 20 and 60 mph. TADS<sup>®</sup> can also prioritize the defects it detects.

The flagged wheels with bearing defects can be relayed to the control center or other respective authorities, using e-mail, page, fax, or modem connection. The system is Automatic Equipment Identification (AEI) integrated and is also compatible with InteRRIS<sup>®</sup> system, according to the TTC [16].

According to the AAR requirement, and to validate a new ABD detector, a teardown inspection must be conducted on 50 bearings flagged by the new system, and the results should present at least a 90 percent positive Level-1 defect rate as discussed below [15].

As outlined in AAR standard S-6000, a defect is Level-1 if any of the following conditions are met [17]:

- Total spalled or water-etched area 1.5 square inches or more on any one cup or cone running surface
- Total spalled or water-etched area 1 square inch or more on any one cup or cone running surface and any spalled area on another running surface
- Any area of orange peel surface. Orange peel surface resembles the look and texture of an orange
- Any loose component indication, such as:
  - o Cone back face wear > 0.010 inch
  - o Indication of turning on the journal for the bearing or its mate
  - o Oversize cone bore
  - o Mounted lateral > 0.030 inch
  - o Average cap screw torque < 50% of criterion in the *Manual of Standards and Recommended Practices*, Section G-II
- AAR-condemnable peeling or smearing
- AAR-condemnable brinelling
- Lubrication failure as described in Section G-II, Recommended Practice RP-631, “Bearing Failure Progression Mode LU”
- Any cracked or broken component
- Any AAR-condemnable roller defect
- Fails criteria for over-heated bearing teardown according to failure progression mode analysis
- Any defect with a depth greater than 1/8 inch
- Fluting/arcing caused by electric current

As of March 2017, 19 TADS<sup>®</sup> detectors are in operation nationwide [18]. Note that more than 50,000 growler type severe bearing defects have been identified by ABD detectors in the U.S. rail network and removed from service since 2007 [8].

Table 3-2 on the following page presents a summary of requirements and specifications of TADS<sup>®</sup> system.

**Table 3-2. Summary of main requirements and specifications of TADS<sup>®</sup> (ABD) system**

Criteria	Type	Value	Notes	Ref.
<b>Site Selection</b>	<b>Site size</b>	25 feet	Three sets of microphone arrays	[15]
	<b>Speed limits</b>	> 40 mph		[15]
	<b>Track Requirements</b>	Tangent track where trains are unlikely to apply brakes		[15]
<b>Operating Parameters and Detector Technology</b>	<b>Type of Operations</b>	Freight, Passenger, Commuter	Applicable for all types of rail operations	[16]
	<b>Resolution</b>	5 levels of severity		[19]
	<b>Measurement Accuracy</b>	N/A		
	<b>Temperature</b>	Dependent on microphone	Lightning protected	[20]
<b>Data Communication</b>	<b>Sensor Technology</b>	Microphones		[20]
	<b>Communication</b>	Email, page, fax, WIFI		[16, 20]
<b>System Thresholds</b>	<b>AEI, RFID?</b>	Yes		[20]
	<b>System Thresholds</b>	Level-1 defect, AAR S-6000		[17]
<b>Action Plan</b>	Send data reports to Railway Control Office			[20]
<b>Calibration, Maintenance</b>	<b>Calibration Frequency</b>	Follow manufacturer recommended practices	Static calibration at least once every 3 years	[21]
	<b>Maintenance Frequency</b>			[21]

### 3.1.2 Railway Bearing Acoustic Monitor (RailBAM<sup>®</sup>)

RailBAM<sup>®</sup> is other ABD systems developed by TrackIQ (now under Wabtec management) to detect early and advanced bearing defects (including extended surface, cone, cup, roller and audible faults) before they grow to a point that may cause service disruption or even derailment due to journal failure [13, 19, 20]. As of March 2017, 20 RailBAM<sup>®</sup> detectors are in operation nationwide and are integrated with the InteRRIS<sup>®</sup> [18].

RailBAM<sup>®</sup> uses acoustic measurements from a series of microphones to listen to passing trains within the speed range of 15 to 80 mph [24, 25].

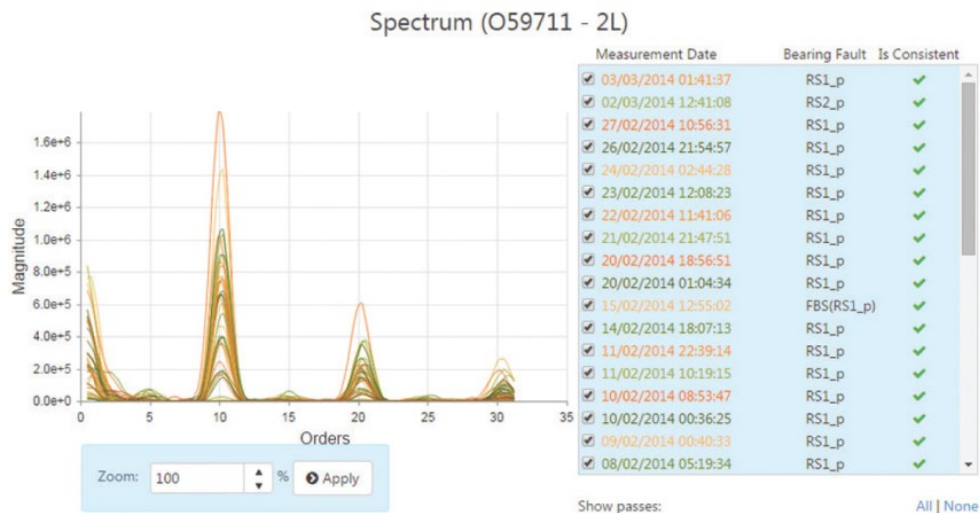




**Figure 3-2. An example of RailBAM® detector installed on the track [24]**

RailBAM® uses two primary components, which are tie mounted auxiliary sensors, and a signal processing electronics rack located in a wayside enclosure. The system can be integrated with an automatic equipment identification (AEI)/radio-frequency identification (RFID) reader to identify an exact car, axle, or wheel on a passing train. The generated alarms can be delivered via SMS, email, or message to the train control centers [24].

The RailBAM® is operated based on identifiable sound characteristics produced by bearing and wheel impact faults. A bearing fault stimulates a structural response of the bearing components that emits sound characteristics of the bearing fault signature. Proprietary signal processing techniques allow the bearing fault signal to be distinguished from the structural noise, enabling fault identification and classification (Figure 3-3). It should be mentioned that RailBAM® can also detect and locate wheel flats based on receiving the acoustic signature through the train consist [23].



**Figure 3-3. Snapshot of the bearings fault signals generated by RailBAM® detector [24]**

The pro-active bearing monitoring of RailBAM® and other similar products can facilitate a more systematic maintenance plan, providing the following benefits [25]:

- Reduction of in-service failures
- Longer maintenance intervals, and
- Minimizing train service interruptions

The RailBAM<sup>®</sup> system can generate the trending history for bearing faults for further analysis and decision making on the faulty car or bearings. Figure 3-4 presents examples of faulty bearings (cup and cone faults) identified by the RailBAM<sup>®</sup> system.



**Figure 3-4. A cup fault (left) and cone fault (right) identified by RailBAM<sup>®</sup> detectors**

Note that the “De-cross” talking feature of RailBAM<sup>®</sup> system using the measured wheel-array geometry and acoustic propagation physics can reduce, in software, the effect of a large fault on one axle from the adjacent axles with small or nonexistent faults [27].

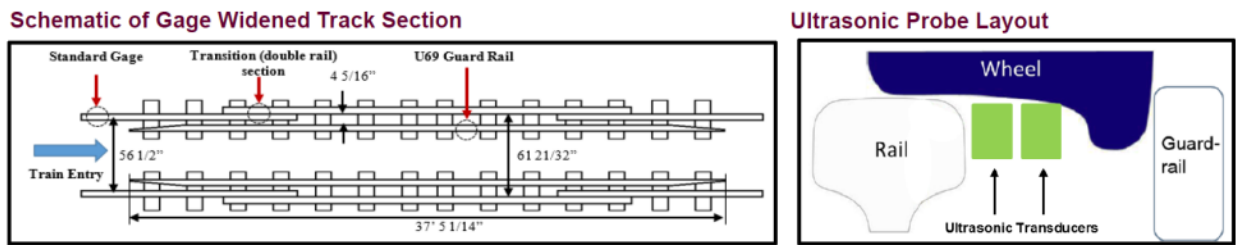
**Table 3-3. Summary of main requirements and specifications of RailBAM® (ABD) system**

Criteria	Type	Value	Notes	Ref.
Site Selection	Site size	6-8 cribs		[24, 28]
	Speed limits	15–80 mph		[24]
	Track Requirements	Tangent track where trains are unlikely to apply brakes		[15, 24]
Operating Parameters and Detector Technology	Type of Operations	Freight, Passenger, Commuter	Applicable to axle box, package and passenger bearings	[16, 24, 26]
	Resolution	Severity Levels of Low, Medium, and High		[26]
	Measurement Accuracy	N/A	Reliability of the system exceeded 95%	[26]
	Temperature	N/A	Suitable for arctic, tropical, and desert environments	[24]
	Sensor Technology	Series of Microphones	Also, signal processing rack	[24, 26]
Data Communication	Communication	Email, SMS, WIFI		[24, 25]
	AEI, RFID?	Yes		[24]
System Thresholds	System Thresholds	Level-1 or Level-2 defect	According to AAR S-6000	[17, 24, 29]
Action Plan	Send data reports to Railway Control Office			[24]
Calibration, Maintenance	Calibration Frequency	Follow manufacturer recommended practices	AAR S-6101 demands static calibration once every 3 years	[21]
	Maintenance Frequency			[21]

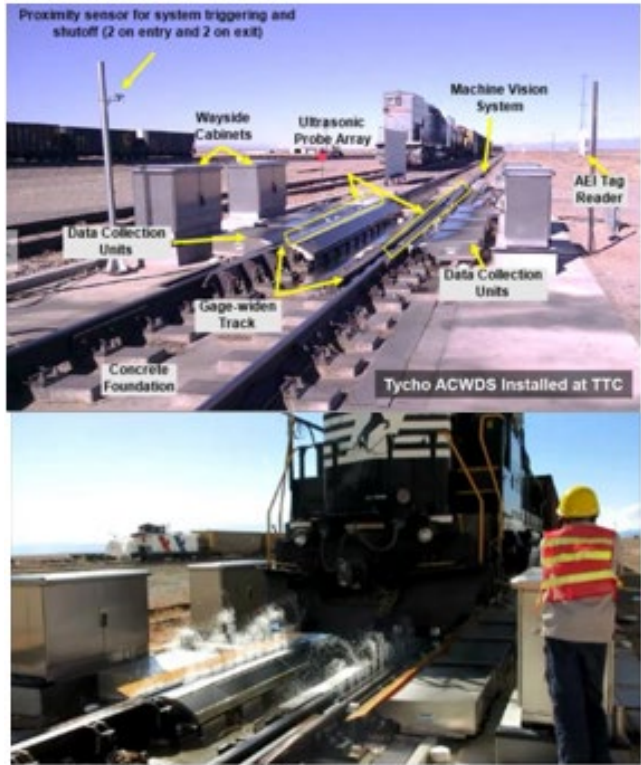
### 3.2 Automated Cracked Wheel Detector (ACWD)

ACWD is a wayside detector used to identify wheel flange cracks and internal defects by submerging the wheel tread through water used as a couplant for ultrasonic detection over the wheel rim [7]. The ACWD system typically requires a relatively stiff track structure (concrete foundation or non-ballasted track) with certain track elements such as guardrails [30].

In addition to submerging the wheel tread through the water, ACWD may apply couplant sprayed onto the lower surface of the rail wheel using a fine mist. The integrity of the wheel is measured by ultrasonic transducers as the wheels pass through the inspection stations at speeds from 5 to 15 mph [25, 26]. As shown in Figure 3-5 and Figure 3-6, the Tycho ACWD detector system has been installed through a wide gage track structure because the ultrasonic equipment should be able to inspect the wheel tread and rim as the wheels pass through. Thus, a guard rail is provided on both inner sides of the track to protect the train against the derailment incident.

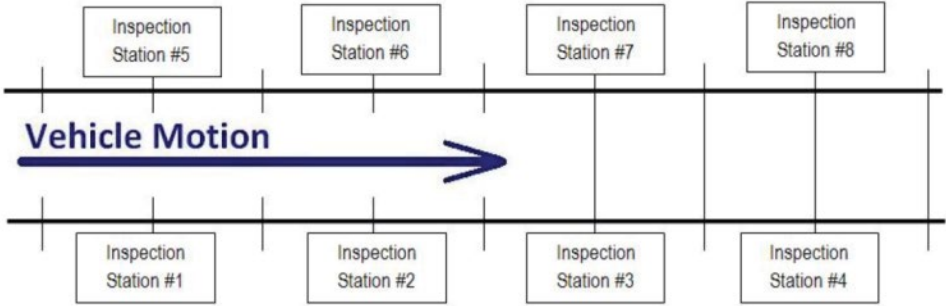


**Figure 3-5. Schematic plan of track structure (wide gauge, guard-rail) for ACWD site [30]**



**Figure 3-6. An ACWD installed at the TTC by Tycho [30] (top), ACWD detector in the TTC is spraying water couplant to conduct ultrasonic inspection on the wheels (bottom) [32]**

Another type of ACWD detector, developed by Nordco for a Class I railroad, also uses ultrasonic technology to detect wheel flaws and cracks through the wheel rim or tread.



**Figure 3-7. Schematic plan of ACWD site developed by Nordco [26]**

As shown in Figure 3-7, Nordco’s ACWD site consists of eight inspection stations on both sides of the track (four stations per rail) with one ultrasonic test head per station. As the cars pass through the inspection stations, the ACWD system sprays couplant onto the lower surface of the wheel. Each ultrasonic station inspects one wheel in a four-wheel sequence, helping the system to distribute the workload among different inspection stations and minimizing the risk of inspection station failure [26].

After detecting a flaw or crack-related defect on a wheel, the system generates a real-time assessment and may report the flaw types, sizes and locations that have been detected in and across the tread and rim of the wheel [26].



Another wheel crack detection technology, developed by MERMEC in Europe, is a non-contact detection system based on using Electromagnetic Acoustic Transducers installed along the track without any requirement for wider track gauge or couplant (Figure 3-8). This ultrasound detector sends acoustic Rayleigh waves through the wheels, which pass by the system at speeds up to 12 mph, and detects any cracks through the wheel tread, after processing the propagated surface waves [9].



**Figure 3-8. Another type of wheel crack detector deployed in Europe using Electromagnetic Acoustic Transducers [9]**

It should be mentioned that there are only a few ACWD systems in the U.S. rail network that are in operation or under development by AAR, FRA, or Class I railroads, and none of them have been integrated into the EHMS-InteRRIS<sup>®</sup> system yet [7].

**Table 3-4. Summary of main requirements and specifications of ACWD system**

<b>Criteria</b>	<b>Type</b>	<b>Value</b>	<b>Notes</b>	<b>Ref.</b>
<b>Site Selection</b>	<b>Site size</b>	25–38 feet	Depends on the system	[30, 31]
	<b>Speed limits</b>	5–15 mph	Depends on the system	[30]
	<b>Track Requirements</b>	Concrete foundation or non-ballasted track (ultrasonic)	Certain track elements such as guardrails are required	[30]
<b>Operating Parameters and Detector Technology</b>	<b>Type of Operations</b>	Freight, Passenger, Commuter	Applicable for all types of rail operations	
	<b>Resolution</b>	N/A		
	<b>Measurement Accuracy</b>	99.83% detection rate		[33]
	<b>Temperature</b>	(-30 °F) to 158 °F	Based on Electromagnetic Acoustic Transducers (MERMEC Technology)	[9]
	<b>Sensor Technology</b>	- 2.5 MHz Ultrasonic transducers + Machine vision - Electromagnetic acoustic transducers	Depends on the system	[9, 30]
<b>Data Communication</b>	<b>Communication</b>	Email, page, WIFI		[30]
	<b>AEI, RFID?</b>			[30]
<b>System Thresholds</b>	<b>System Thresholds</b>	Vertical split rim and shattered rim crack		[30]
<b>Action Plan</b>	Send data reports to Railway Control Office			[30]
<b>Calibration, Maintenance</b>	<b>Calibration Frequency</b>	Follow manufacturer recommended practices	static calibration at least once every 3 years	[21]
	<b>Maintenance Frequency</b>			[21]

### 3.3 Dragging Equipment Detector (DED)

DED is a common wayside detector system that can protect rolling stock, cargo, and track structures by detecting the components of rolling stock that are loose and dragging under moving trains [7, 13]. There are several types of DED detectors designed by different manufacturers. However, a DED system typically consists of physical sensors mounted on top of the track ties, as shown in [Figure 3-9](#) and [Figure 3-10](#).

DEDs use acceleration sensors to detect dragging equipment. A typical DED system is capable of detecting any strikes with accelerations up to 600 g [10]. Railroads can program the detectors to send an alarm at whatever threshold deemed necessary [3]. The DED system can also be equipped with a “Talker” feature to instantly announce the location of loose equipment on the train, using radio communications with train crew [30].



**Figure 3-9. An example of a Dragging Equipment Detector (DED) [3]**

Generally, when a DED alarm is generated by the system, another DED alarm is not to be reported until the alarm contacts have closed and reopened and at least three axles have been counted by the system since the previous alarm. Such a system configuration can prevent multiple alarms being generated by one contact opening [35].



**Figure 3-10. A dragging component detected by DED system [10]**

The “Third Rail Fouler” detector is a particular DED system along electrified tracks with a third rail power system. It can detect any components of the rolling stock penetrating the third rail clearance envelope. The system is mainly applicable in urban transit (subway) and commuter rail systems where freight trains may operate on the same track as commuter services. This detector can identify any dragging object on freight trains that may cause damage to the third rail equipment before it enters the commuter train territory [7].

More than 1,000 DED detectors are in-operation, nationwide, but they are not integrated through EHMS-InteRRIS<sup>®</sup> system [7, 13].

**Table 3-5. Summary of main requirements and specifications of DE**

Criteria	Type	Value	Notes	Ref.	
<b>Site Selection</b>	<b>Site size</b>	Minimal	Mounted to tie		
	<b>Speed limits</b>	N/A			
	<b>Track Requirements</b>	Any track structure	Fit any gauge and width	[3, 34]	
<b>Operating Parameters and Detector Technology</b>	<b>Type of Operations</b>	Freight, Passenger, Commuter	Applicable for all types of rail operations		
	<b>Resolution</b>	N/A			
	<b>Measurement Accuracy</b>	N/A			
	<b>Temperature</b>		(-40) to 160 °F	Depends on the system	[34]
			(-4) to 158 °F	Depends on the system	[3]
<b>Sensor Technology</b>	Acceleration sensors, (Vision camera is optional)	Interface directly to hot bearing detector or micro talker		[3, 34]	
<b>Data Communication</b>	<b>Communication</b>	Email, page, fax, WIFI,		[10]	
	<b>AEI, RFID?</b>	Yes	Optional	[36]	
<b>System Thresholds</b>	<b>System Thresholds</b>	Up to 600 g acceleration	Alarm threshold can be set to any value in this range	[3, 10]	
<b>Action Plan</b>	Alert train crew and operation centers immediately			[34]	
<b>Calibration, Maintenance</b>	<b>Calibration Frequency</b>	Follow manufacturer recommended practices	AAR S-6101 demands static calibration once every 3 years	[21]	
	<b>Maintenance Frequency</b>			[21]	

### 3.4 Hot Box Detector (HBD) & Hot Wheel Detector (HWD)

Bearing failure is one of the major rolling stock problems for rail operators. It causes approximately 20 percent of the \$800 million wheel removals (\$160 million), annually, in the North American rail network [37]. Therefore, the HBD is a very common wayside detector system to monitor and identify hot journal bearings using an infrared thermal detection system as wheelsets pass over the detector [13].

A bearing can become overheated very quickly and may even burn off in just 1 to 3 minutes. On the other hand, it may cool off at reduced speed or stop point before it can be confirmed by a detector system [37]. Thus, the North American railroads have installed more than 6,000 HBD detectors throughout their network to reduce the risk of bearing failures due to overheating [13]. As result, there is an HBD system every 25 miles, approximately, along Class I freight rail networks [15]. Train accident rates caused by axle and bearing-related factors have dropped 81 percent since 1980 and 59 percent since 1990 due to the use of HBD detectors [38].

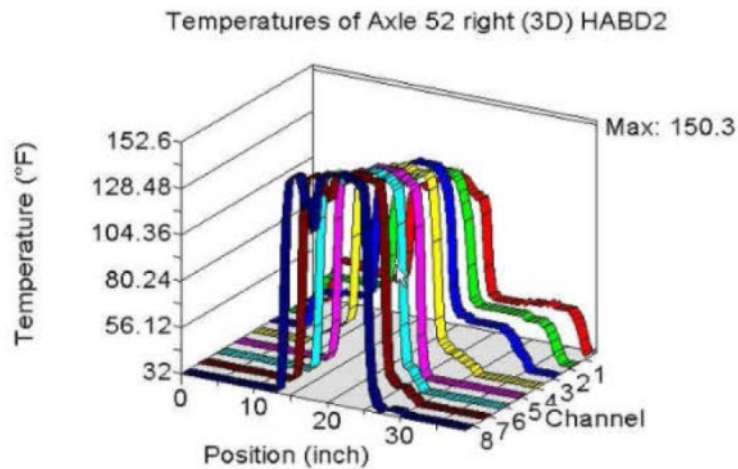
It is a common practice for railroads to combine the HBD with a hot wheel detector (HWD) system to identify both hot journals (due to bearing defects) and hot wheels (due to unreleased hand brake, automatic brakes not fully released and sticking brake shoes or disks) (Figure 3-11). HBD and HWD use similar infrared scanning technology (and in some cases even interchangeable detectors), though their decision algorithms and threshold criteria are different for detecting bad bearings and brakes<sup>2</sup> [39, 40].

<sup>2</sup> As of 2016, AAR has established S6031 for WTD detectors.





**Figure 3-11. An example of HBD system (outer detectors) combined with HWD system (inner detectors) [41]**



**Figure 3-12. An example of a hot journal flagged by an HBD detector with multi-scan system (eight channels) [43]**

As shown in [Figure 3-12](#), HBD system can be configured with multi-scan mode to improve the reliability of identifying a hot bearing.

According to AAR’s interchange rules, each of the detector types have condemning limits that permit a component such as a wheelset to be taken out of service and replaced when the component meets or exceeds the noted condition. For a HBD [39]:

- The threshold is 76.7 °C (170 °F) above ambient and hotter than that side of the train, or
- 35 °C (95 °F) above the temperature of the mating bearing on the same axle

HBD systems utilize a series of rules and algorithms to verify that hot bearings are not the result of heat generated by the sun, or by defective brakes generating additional heat. Bearings temperatures are analyzed individually and compared with the train’s norm [15].

The HBD detection is evaluated based on three specific levels of bearing rules, in which level 1 represents the most severe condition of the bearings. Each railroad may define different rules and criteria to evaluate its bearing conditions. For instance, Burlington Northern Santa Fe Railway

(BNSF) has a program for managing hot wheel bearings with more than 100 rules and more than 500 variations [15].

When hot journals are detected, the train should be inspected and will be operated at a reduced speed, if necessary, until it reaches a set-out location where the car can be removed from the train. When a hot wheel is detected, the flagged car is inspected, and then if the problem can be remediated, the car will continue its operations. However, if a repair cannot be made on the car, its brakes will be cut out and the car will be moved to the next available set-out location [15].

The maximum speed coverage of HBD and HWD systems varies from 100 to 300 mph based on different manufacturer claims. Also, both systems can be equipped with the “Talker” feature to directly inform the train crew of bearing and wheel problems, if integrated with an AEI reader [10, 39].

There are certain conditions that should be considered when selecting a location for HBD and HWD systems. Some of these primary requirements are [44]:

- Site should be on level and tangent track
- In an area where trains do not normally require heavy braking applications
- At least 300 feet away from any grade-crossings
- Away from track joints, switch and side tracks
- Passing trains should usually traverse with at least 10 mph along the selected location
- Track structure should be stable and well maintained. If needed, ties and fastening system should be replaced, track should be tamped, and ties spacing should be reduced to improve the track quality and stability level.

Depending on the manufacturer, HBD and HWD sensors should be carefully installed to measure journal or wheel rim temperatures. For instance, according to a guide developed by Southern Technologies Corporation (STC), HBD scanners should be aligned to scan the bottom 3.5 inches of the bearing housing, about 7.25 inches from the gauge line. In addition, HWD scanners should be aligned to scan approximately 4 inches above the rail, as demonstrated in [Appendix D](#) [44].

Note that the HBD and HWD systems are not integrated into the EHMS-InteRRIS<sup>®</sup> and individual railroads and car owners utilize the data from these sites to monitor bearings and hot wheels on their fleets using proprietary trending and threshold limiting analysis [7].

Recently, the AAR has developed standards for detecting cold and hot wheels and the HWD systems will be covered under the same [41].

**Table 3-6. Summary of main requirements and specifications of HBD and HWD systems**

Criteria	Type	Value	Notes	Ref.
Site Selection	Site size	1 crib (infrared detectors) + 2 cribs for rail contacts	May vary based on manufacturer	[41, 44]
	Speed limits	- Lower limit: 10 mph - Upper limit of between 100 and 300 mph	May vary based on manufacturer	[10, 44]
	Track Requirements	On tangent and level track where braking is uncommon	certain manufacturer may require certain track specs (e.g., steel tie for the detector cribs)	[44]
Operating Parameters and Detector Technology	Type of Operations	Freight, Passenger, Commuter	Applicable for all types of rail operations	
	Resolution	± 1 K	May vary based on manufacturer	[41]
	Measurement Accuracy	HBD: ± 1 K HWD: ± 3 K	May vary based on manufacturer	[41]
	Temperature	(-22 °F) to 158 °F (-40 °F) to 160 °F	May vary based on different manufacturers	[39, 41]
	Sensor Technology	Infrared detectors		[13, 39, 40, 41]
Data Communication	Communication	Email, page, fax, WIFI, Radio	Talker feature is available	[15, 23]
	AEI, RFID?	Yes		[7, 23]
System Thresholds	HBD	- X > 170°F above the average bearings of train - X > 95°F above the mate bearing on the same axle	Depends on the RR rules	[15, 42]
	HWD	X > 650°F (level 3) 500 < X < 650°F (level 2) X < 500°F (level 1)	Depends on the RR rules	[15, 42]
Action Plan	HBD	Inspect the train, restricted speed; remove bad car from train at the next set-out location.		[15]
	HWD	Stop the train and inspect, the car continue the operations if problem resolved; otherwise cutout the brake on bad car up to the next set-out point. (for HWD level 1)		[15]
Calibration, Maintenance	Calibration Frequency	AAR S-6101 demands static calibration once every 3 years	Auto-calibration for some systems using a calibrated heat source	[21, 44]
	Maintenance Frequency			[21]

### 3.5 Truck Bogie Optical Geometry Inspection (TBOGI)

TBOGI is a wayside detector system used to measure the performance of a rail car’s axle and wheel suspension assembly, by using a laser-based monitoring system combined with a high speed camera along a tangent section of track as a train passes over the detector (Figure 3-13) [13].

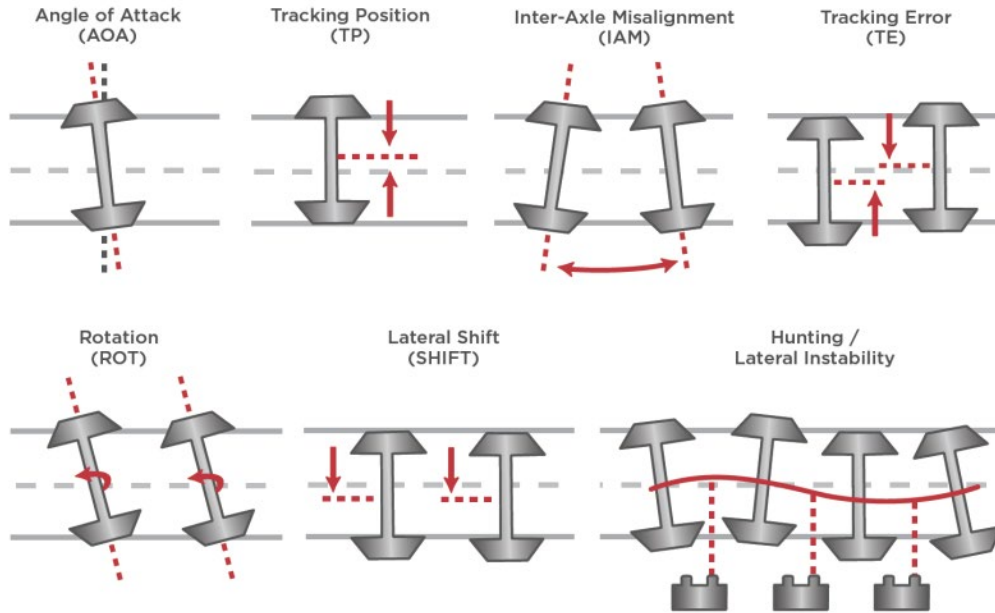


**Figure 3-13. TBOGI system to identify poorly performing trucks [8]**

The TBOGI can measure the lateral position (or tracking position) and angle of attack of each axle of passing trains up to a maximum speed of 180 mph. In addition, the TBOGI-HD edition can measure laterally unstable trucks due to hunting issues on passing cars, by converting the maximum lateral distance to a measure of truck hunting, using a triple box configuration of TBOGI, as shown in [Figure 3-14](#) and [Figure 3-15](#) [8, 42, 43].



**Figure 3-14. Triple-box configuration of a TBOGI-HD system [47]**



**Figure 3-15. Different types of geometrical errors of trucks which can be detected by TBOGI-HD [46]**

The TBOGI system alerts can be automatically set up based on different threshold configurations. For instance, BNSF has implemented a three-level threshold rule for its eight TBOGI sites which were installed through their network since 2006. These three level thresholds are handled as follows [44, 45]:

- **Level 3 (least severe):** Automatically generated and automatic handling. Handled at destination or during empty cycle.
- **Level 2 (moderate level):** Automatically generated and manual handling. Due to the increased severity, manual handling is required to pick more specifically when and where it would be best to inspect.
- **Level 1 (most severe):** Automatically generated and manual handling. This alert level may require the train to be stopped immediately.

As of March 2017, 28 TBOGI detectors (12 of them are TBOGI-HD) are in operation nationwide, and integrated within InteRRIS<sup>®</sup> system [13, 18].



**Table 3-7. Summary of main requirements and specifications of TBOGI system**

Criteria	Type	Value	Notes	Ref.
Site Selection	Site size	5–25 feet	Depends on the type of system TBOGI, or TBOGI-HD	[46, 48]
	Speed limits	180 mph		[46]
	Track Requirements	Tangent track		[46]
Operating Parameters and Detector Technology	Type of Operations	Freight, Passenger, Commuter	Applicable for all types of rail operations	[46]
	Resolution	N/A		
	Measurement Accuracy	N/A		
	Sensor Technology	Laser + camera		[46, 47]
Data Communication	Communication	Email, SMS, WIFI		[48]
	AEI, RFID?	Yes		[48]
System Thresholds	Various thresholds based on different types of geometrical errors, such as: <ul style="list-style-type: none"> <li>- Hunting &gt; 33 mm</li> <li>- Tracking position &gt; 24 mm</li> </ul>			[48, 49]
Action Plan	Send data reports to Railway Control Office: Level 3 -least severe (Info); Level 2 -moderate (when and where to inspect); Level 1-most sever (stop the train and inspect immediately)			[48]
Calibration, Maintenance	Calibration Frequency	Follow manufacturer recommended practices	AAR S-6101 demands static calibration once every 3 years	[21]
	Maintenance Frequency			[21]

### 3.6 Truck Hunting Detector (THD)

THD is a wayside detector to evaluate a truck’s ability to maintain the centerline of the rail at relatively high speeds (greater than 40 mph), when operating empty or lightly loaded. There are two types of THD available in the market. The first system is based on rail strain gages that measure lateral wheel forces on tangent track, while the other system is based on laser measurements of the angle of attack and the lateral position of an axle, similar to the TBOGI system [7, 13, 15].

The force-based THD systems consist of a series of strain gages, which can be co-placed along a WILD site. The THD site typically needs a 30 to 50-foot array of strain gages welded to the web of the rail, which measures the lateral forces created by running car wheels on the rail (Figure 3-16). The force data gathered from each wheel are evaluated using an index value (Hunting Index), which is used to identify defects depending on the acceptable thresholds and criteria configured for the system [6, 15].




**Figure 3-16. THD system based on strain-gage detectors [6]**

On the other hand, the laser based THD system consists of three modules. Each module contains an emitter and receiver for sending and receiving a laser beam. The modules are approximately 10 feet apart and located just above the head of the rail. The collected data of a laser based THD is generated based on the speed, amplitude, and frequency of the laser beam as it is received [15].

The THD condemnable thresholds are typically evaluated based on a truck Hunting Index (HI) that should be less than 0.20 [29, 50]. The HI uses an algorithm based on correlated lateral and vertical data received from the THD detectors and is typically scaled between 0 and 1; though under certain conditions the HI can be negative, too. An HI less than 0.1 demonstrates a stable truck, while any values above 0.65 indicate a truck with very poor hunting stability [51, 52]. HI with values higher than 0.1 show a degradation trend through the truck suspension system [51]. As an example, [Figure 3-17](#) demonstrates history of THD alerts on a given car.

When a car is flagged by THD, different levels of inspection or maintenance actions may be required depending on the HI thresholds defined, including adherence to AAR Interchange Rule 46, Section H. For instance, if the HI is not beyond the condemning thresholds, the flagged car may continue its operations up to the destination or unloading location; otherwise it should be only operated up to the next set-out point [52].

Data Summary Details	
Equipment ID: 	Location: TRUCK B Data Summary: Truck hunting data summary
<a href="#">Hide Criteria</a>	
Opening Criteria: Truck hunting index $\geq 0.20$	
Autoclose Criteria: 12 consecutive truck hunting index reads $< 0.09$ , four of which are lightly loaded, $< 40$ tons/truck	
Autoclose in progress.	
Note: all times are Eastern Standard Time (EST)	<a href="#">Show Aggregate Method</a>
Name	Aggregation
Open Date	12-31-2013 10:25
Last Event Date	03-09-2014 01:58
Count of DS Creators	2
Count of detector reads	3
Count of consecutive reads where the hunting index $< .09$	2
Count of reads where the hunting index $\geq .2$ and $< .35$	0
Count of reads where the hunting index $\geq .35$	1
Timestamp of last read where hunting index $\geq .09$	12-31-2013 10:25
Maximum hunting index	0.36
Latest hunting index	0.06
Latest timestamp where hunting index $\geq .2$ and $< .3$	
Latest timestamp where hunting index $\geq .3$ and $< .35$	
Latest timestamp where hunting index $\geq .35$ and $< .4$	12-31-2013 10:25
Latest timestamp where hunting index $\geq .4$ and $< .5$	
Latest timestamp where hunting index $\geq .5$ and $< .55$	
Latest timestamp where hunting index $\geq .55$ and $< .65$	
Latest timestamp where hunting index $\geq .65$	
Second latest timestamp where hunting index $\geq .2$ and $< .3$	
Second latest timestamp where hunting index $\geq .3$ and $< .35$	
Second latest timestamp where hunting index $\geq .35$ and $< .4$	
Second latest timestamp where hunting index $\geq .4$ and $< .5$	
Second latest timestamp where hunting index $\geq .5$ and $< .55$	
The following timestamps include hunting index $< 0.09$ and truck weight $\geq 40$ tons	
Timestamp of last read	03-09-2014 01:58
Timestamp of 2nd to last read	01-30-2014 07:42
Timestamp of 3rd to last read	
Timestamp of 4th to last read	
Timestamp of 5th to last read	

**Figure 3-17. A sample history of THD alerts and info on a given rail car monitored through InteRRIS®- EHMS system [29]**

The maintenance and calibration requirements of THDs, are as follows [21]:

- *“THDs must be maintained such that each rail has at least 70% of both vertical and lateral circuits active (so as to determine L/V ratios at that rail at a crib). If less than 70% of both vertical and lateral cribs are active on either rail, then the data from that site does not meet the validation requirements.*
- *The average vertical weight for all wheels measured must be calculated for each active circuit. The range (maximum-minimum) of these average weights for a rail must be less than 15 kips for any train set containing 50 or more axles. If the range is greater than 15 kips, then data from that rail does not meet the validation requirements.*
- *The average lateral load for all wheels measured must be calculated for each active circuit. The range (maximum-minimum) of these average weights for a rail must be less than 6 kips for any train set containing 50 or more axles. If the range is greater than 6 kips, then data from that site does not meet the validation requirements.”*

AAR standard S-6101 also lists the following data requirements for THD calibration [21]:



- “The range of average weight variation for each rail for each train must be provided with the train data set.
- The range of lateral load variation for each rail for each train must be provided with the train data set.
- The percentage of active L/V circuits per rail must be provided with the train data set.”

The typical installation of strain-gage THD systems requires concrete ties along the measurement zone and the approaching segments. Also, changing tie spacing may be required to increase the measurement accuracy level. The THD system may require sensors to detect and count the axles or read the AEI/RFID tags. Typically, a central location server (in a bungalow) is located next to the THD sensors to store and compare the collected data to the defined thresholds and generate alarms and send them to the authorized users [47].

As of March 2017, 94 THD detectors are in-operation nationwide, which were integrated under the InterRIS<sup>®</sup>/EHMS system [18]. Note that since implementing THD systems in the U.S. rail network, more than 20,000 freight cars were flagged by THDs, and these cars were repaired [8].

**Table 3-8. Summary of main requirements and specifications of THD system**

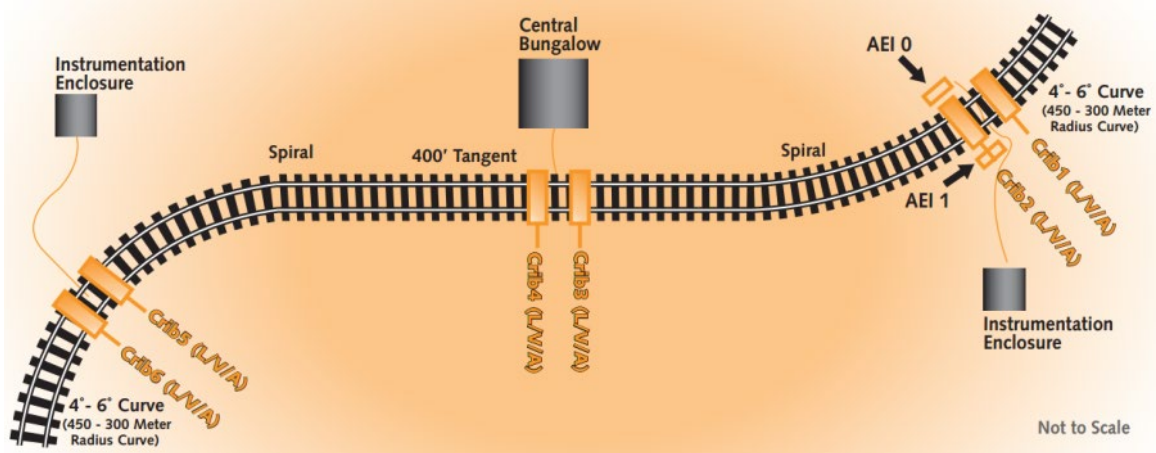
Criteria	Type	Value	Notes	Ref.
Site Selection	Site size	30–50 feet	Depends on the system	[15]
	Speed limits	Operating speeds of 30–180 mph	Depends on the system	[6, 51, 53]
	Track Requirements	Tangent track (For strain-gage, concrete tie is recommended)	Depends on laser-based or strain-gage system	[51, 52, 53]
Operating Parameters and Detector Technology	Type of Operations	Freight, Passenger, Commuter	Applicable for all types of rail operations	[52]
	Resolution	± 0.1 mm	Depends on the system	[54]
	Measurement Accuracy	0.016 mm	Depends on the system	[54]
	Temperature	(-40 °F) – 158 °F	Depends on the system	[6]
	Sensor Technology	Strain gages; or laser technology	Two different systems	[15]
Data Communication	Communication	Email, SMS, WIFI		[6, 47]
	AEI, RFID?	Yes		[6, 47]
System Thresholds	System Thresholds	It varies based on “Hunting Index” thresholds: AAR condemnable: 1 HI ≥ 0.5 or, 2 HI ≥ 0.35 (in 12 months)		[50, 51, 52]
Action Plan	Car owner can choose to shop the car and make repairs		If “0.2 ≤ HI < 0.5”	[50]
	Shop the car immediately		If “HI ≥ 0.5 or, HI ≥ 0.35” twice in 12 months)	[50]
Calibration, Maintenance	Calibration Frequency	Follow manufacturer recommended practices, and AAR standard S-6101	Static calibration once every 3 years	[21]
	Maintenance Frequency			[21]

### 3.7 Truck Performance Detector (TPD)

TPD is a wayside detector system, which evaluates the suspension performance of trucks by measuring the vertical and lateral forces generated by the wheels as a car moves over the detectors that are placed along instrumented track [7, 13].

Similar to THD, TPD is also categorized on two different technologies: a strain-gage (force-based) system and a laser-based system [15]. In force-based TPDs an array of strain gages are installed throughout an “S” curve segment of track with 4–6 degrees of curvature, including six to eight cribs of strain gages, in which two (or three) of them are placed in the constant radius portion of both curves and two in the tangent section [15, 52], as shown in Figure 3-18. Each crib measures both lateral and vertical forces applied to the rail, which are converted to an index value to measure the risk severity of the defects related to the truck performance along the curves [15]. The angle of attack is also measured using the time differential between the high and low rails, with different levels expected in the radial segments of track versus the tangent segment [47].

The laser-based TPDs consist of one module, an emitter and receiver, which generate and receive a laser beam, similar to the TBOGI system and the laser-based edition of THD. The elapsed time between sending and receiving the laser beam is compared and evaluated based on a known distance from module to reference rail. The difference between the measured value and the benchmark value is used to evaluate the truck performance. Unlike the force-based TPD system, the laser-based THDs should be installed along a tangent segment of the track [15, 43].



**Figure 3-18. Force-based TPD cribs and detectors laid-out along a given S-curve [53]**

The TPD wayside detector can flag cars with the following defects [54, 55]:

- Worn friction wedges
- Broken suspension springs
- Twisted car bodies
- Mismatched side frames
- Hollow/Worn wheels
- Tight side bearings

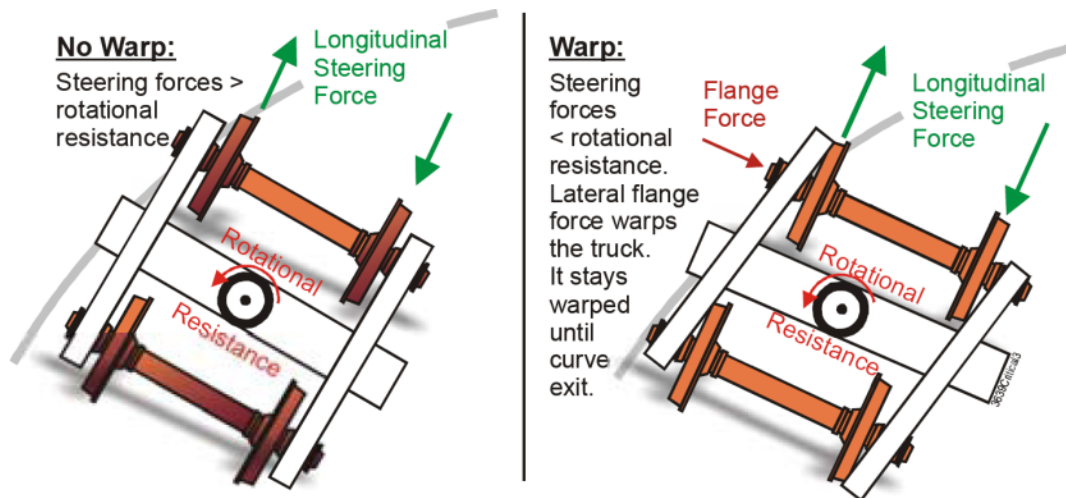
In the force-based type of TPD, the system detects the truck issues based on calculating the gauge widening forces of crib pairs for each truck along the circular curve and the mean force for the entire train. The condemnable levels of TPD are classified based on L/V (TPDL) and gauge spread (TPDG) thresholds, in which the first one deals with lateral over vertical force

measurements; while the latter refers to truck performance gauge (in other words the measurement of the horizontal force of the truck against the inside rails, pushing them outward) [50]. According to AAR, the condemnable levels of TPD systems are defined as below [18]:

- TPDL: LAHRLV<sup>\*3</sup> ≥ 1.05 twice in 12 months
- TPDG: Gauge Spread ≥ 28+ kips (by degree curve) twice in 12 months

To assess if the TPD system produces reliable data, the requirements are that the absolute value of average truck gauge spread force for a train (TPDG), which is calculated at each two cribs in the curves, or along the tangent segment, be greater than or equal to 10 kips. Further, the lower mean truck gauge spread force calculated at one crib for the train should not be less than 50 percent of that of the higher mean truck gauge spread force measured at the other crib for that train. In addition, the lateral force of each single wheel at any crib, TPDL, should not be greater than 45 kips. Also, the standard deviation of lateral force for a train at any crib should be greater than zero but less than or equal to 8 kips. Similarly, the standard deviation of vertical force for a train at any crib should be greater than zero [21].

According to research conducted by the TTC, most poor performance trucks of freight cars detected by TPD are caused by high rotational resistance at the truck-body interface, as shown in Figure 3-19 [51].



**Figure 3-19. Flange and longitudinal creep forces acting against the rotational resistance between truck and carbody [51]**

It should be noted that the truck-car body rotational resistance can be caused by [51]:

- High friction coefficients on:
  - The horizontal surface of the center bowl
  - The side wall of the center bowl
- Body twist (causing high side bearer loads and off-center vertical load distributions)

<sup>3</sup> LAHRLV: Lead Axle High Rail Lateral over Vertical ratio (L/V)

- Twisted center plates across a wagon body
- Non-flat (concave) center bowls and center plates (as a result of carbody twist)

As of March 2017, 14 TPD detectors are in operation nationwide. Also, the TPD system has been integrated through the InteRRIS<sup>®</sup> database management system [18]. It should be mentioned that since implementing TPD systems in the U.S. rail network, approximately 5,000 freight cars have been flagged by TPDs and repaired [8].

**Table 3-9. Summary of main requirements and specifications of TPD system**

Criteria	Type	Value	Notes	Ref.
Site Selection	Site size	(Force based): 6–8 cribs in three segments of a “S curve” (Laser-based): at least 3 cribs along tangent track		[47, 55, 56]
	Speed limits	10–180 mph	Depends on manufacturer	[56]
	Track Requirements	Ballasted or slab tracks	All tracks should be stable and maintain the same specs.	[55, 56]
Operating Parameters and Detector Technology	Type of Operations	Freight, Passenger, Commuter	Applicable for all types of rail operations	
	Resolution	10 lbs.	Depends on manufacturer	[56]
	Measurement Accuracy	1%	Depends on manufacturer	[56]
	Temperature	32 °F–130 °F (Electronic component)	Depends on manufacturer	[56]
	Sensor Technology	- Strain gages, or - laser based system	Depends on manufacturer	[15, 56]
Data Communication	Communication	Email, SMS, WIFI		
	AEI, RFID?	Yes	Optional	
System Thresholds	LAHRLV* $\geq 1.05$ twice in 12 months * <i>Lead Axle High Rail Lateral/Vertical</i>		For TPD <sub>L</sub> : Lateral or vertical force measurements	[21]
	Gage Spread $\geq 28+$ kips (by degree curve) twice in 12 months		For TPD <sub>G</sub> : Horizontal force against inside rails	[21]
Action Plan	Auto alarms are generated based on measured vertical and lateral forces as mentioned above		Strain gage-based	[56]
Calibration, Maintenance	Calibration Frequency	- Average vertical force of each two cribs <10 kips - St Dev. of vertical force for a train on each crib $\neq 0$		[21]
		- Lateral force on each wheel <45 kips - St Dev. of lateral force for a train <8 kips		[21]
	Maintenance Frequency	NA		

### 3.8 Weigh-In Motion Detector (WIM)

WIM is a wayside detector system that can measure the weight of a rail vehicle (vertical load) and analyze any overload, side-to-side imbalance, or end-to-end imbalance condition of the cars while they are moving in the 1–180 mph speed range, depending on the type of WIM system. WIM can be combined with a WILD system or it can be installed as a stand-alone detector [5, 9].



**Figure 3-20. WIM strain gages attached to the web of the rail on an instrumented track [9]**

WIM should be integrated with an AEI reader to identify the car with imbalance or over-loaded axles and automatically report the problem. There are certain weight related alarms that can be reported depending on the WIM system characteristics, but some of the common reportable problems are as follows [4]:

- Axle overload
- Transverse axle imbalance
- Transverse load imbalance
- Longitudinal load imbalance

The WIM systems can be developed with self-diagnostic capabilities in a way that if any major part of the system fails (sensors, measurement equipment), the system can detect such problems and send a warning alarm to the system users [5, 56].

According to Union Pacific Railroad (UP), during July 2005 and September 2006, more than 11 million vehicles were monitored by 13 WIM systems on UP main tracks. Out of 11 million records captured by WIM systems, only 439 vehicles exceeded the max loading capacity by more than 10 percent [57].

[Table 3-10](#) presents a summary of main requirements and specifications of a WIM system.



**Table 3-10. Summary of main requirements and specifications of WIM system**

Criteria	Type	Value	Notes	Ref.
Site Selection	Site size	30 - 50 feet	Depends on system specs provided by manufacturer	[5, 9]
	Speed limits	1 – 65 mph [59] 10 – 180 mph [5] 3 – 185 mph [9]	Depends on manufacturer	
	Track Requirements	Ballasted or slab tracks (tangent segment)	All tracks at the site should be stable and maintain the same specs.	[5, 59]
Operating Parameters and Detector Technology	Type of Operations	Freight, Passenger, Commuter	Applicable for all types of rail operations	
	Resolution	100 lbs.	Depends on manufacturer	[5]
	Measurement Accuracy	2%	Depends on manufacturer	[5, 59]
	Temperature	(-40 °F)–185 °F	Depends on manufacturer	[59]
	Sensor Technology	- Strain gages, - Fiber optic sensors - Weigh beams along the special ties	Depends on manufacturer	[4, 5, 9, 59, 61]
Data Communication	Communication	Email, SMS, Fax, WIFI	“Talker” feature is available	[4, 5, 9, 10, 59]
	AEI, RFID?	Yes		[4, 5, 9, 59]
System Thresholds	Vertical force (%)	- Typically over 10% of the weight limit of the car - % of weight between side to side and end to end imbalance		[60]
	L/V measurement	Additional sensors are needed		[23]
Action Plan	Auto alarms are generated based on measured forces			[5]
Calibration, Maintenance	Calibration Frequency	At least once a year	May have auto calibration capabilities	[59]
	Maintenance Frequency	NA		

### 3.9 Wheel Impact Load Detector (WILD)

The WILD system is one of the most common wayside detectors. It is used to identify the wheels with potential tread defects such as flat spots, out-of-rounds, built-up treads, and shells that result in high impact loads, which cause damage to the vehicle and truck components, as well as to the track structure. Different WILD systems were manufactured under different commercial names such as WILD [4, 9, 59, 60], WheelCheX® [12], MultiRail® WheelScan [64], WCM® [65], and ATLAS FO [66].



**Figure 3-21. Strain gages of WILD system attached to the inner sides of rail web [65]**

As of March 2017, more than 185 WILD detectors are in operation nationwide and have been integrated through the InteRRIS<sup>®</sup> system [18]. [Table 3-11](#) presents a summary of the main requirements and specifications of the WILD system. More details about WILD systems are provided in the [Section 4](#).

**Table 3-11. Summary of main requirements and specifications of WILD system**

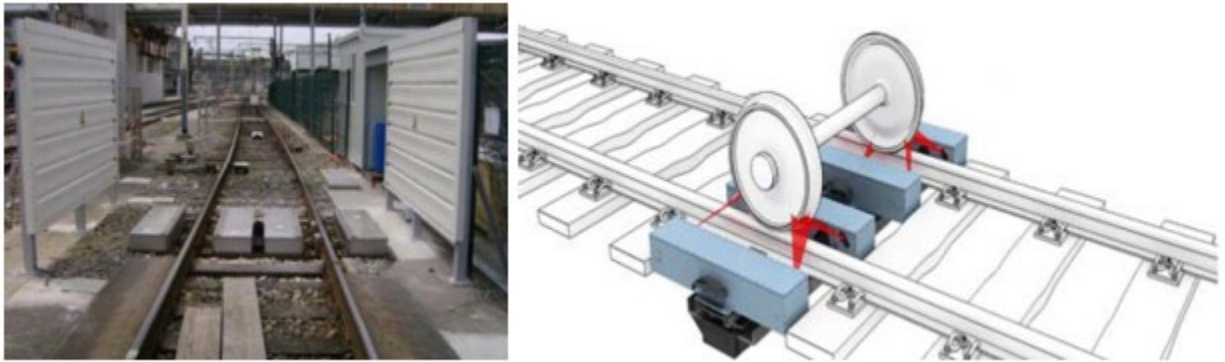
Criteria	Type	Value	Notes	Ref.
Site Selection	Site size	20–50 feet	Depends on system specs provided by manufacturer	[4, 9, 23, 61, 62, 63, 64, 66, 67, 68]
	Speed limits	> 15 mph	Recommended speed is 30–50 mph	
	Track Requirements	Ballasted or slab tracks (tangent segment)	All tracks at the site should maintain the same specs.	
Operating Parameters and Detector Technology	Type of Operations	Freight, Passenger, Commuter	Applicable for all types of rail operations	
	Resolution	11-100 lb., 0.2 mm wheel flat depth, or 5 mm spall detection	Depends on manufacturer and type of WILD system	[4, 9, 23, 61, 62, 63, 64, 66, 67, 68]
	Measurement Accuracy	2%–10%		
	Temperature	(-40 °F)–158 °F	Depends on manufacturer	[4, 9, 61, 62, 64, 65, 66]
	Sensor Technology	Accelerometers and strain gages,	Depends on manufacturer	[4, 9, 23, 61, 62, 63, 64, 66, 67, 68]
Data Communication	Communication	Email, SMS, Fax, WIFI	Primarily to dispatching system, also a “Talker” feature with train crew is available	[4, 11, 62, 64]
	AEI, RFID?	Yes		[4, 11, 62, 64]
System Thresholds	Commuter	Dynamic Ratio $\geq 3$		[11, 12]
	AAR	Peak load $\geq 65$ kips		[1, 69]
Action Plan (Commuter)	Check car during normal maintenance		If $2 \leq DR < 3$	[1, 11]
	Inspect car before next scheduled maintenance		If $3 \leq DR < 4$	
	Stop train in next station and check the car		If $4 \leq DR < 5$	
	Stop train immediately and inspect the car, (may reduce speed to 10 mph)		If $5 \leq DR$	
Action Plan (AAR)	Car owner can choose to shop the car and make wheel repairs		$65 \text{ kips} \leq \text{Peak load} < 80 \text{ kips}$	[1, 69]
	Repair the wheels if the car is shopped for any non-wheel related repairs		$80 \text{ kips} \leq \text{Peak load} < 90 \text{ kips}$	
	Shop the car ASAP		$90 \text{ kips} \leq \text{Peak load} < 140 \text{ kips}$	
	Inspect the train immediately and set out the affected car (speed below 30 mph)		$140 \text{ kips} \leq \text{Peak load}$	
Calibration, Maintenance	Calibration Frequency	Once a year (Commuter) at least once in 3 years (Freight)	Some systems have auto calibration capabilities [4, 9, 10]	[1, 12]
	Maintenance Frequency	Twice a year (Commuter)		[1, 12]

### 3.10 Wheel Profile Measurement System (WPMS)

WPMS, also known as Wheel Profile Detector (WPD), is a wayside detector system used to determine wheel wear, flange height and thickness, rim thickness, and hollow tread problems by using a laser-based scanning system and capturing profile pictures with high-speed digital



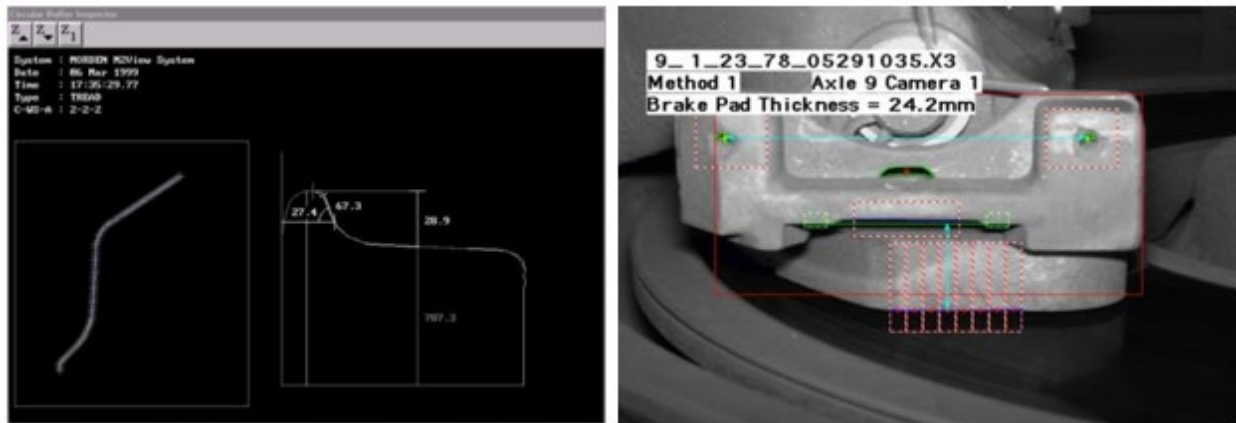
cameras (Figure 3-22) [7, 9, 13]. The system has not been integrated into the EHMS system yet [7], and as of March 2017, 15 WPMS detectors are in operation nationwide [18].



**Figure 3-22. An example of WPMS system with laser triangulation and matrix camera [9]**

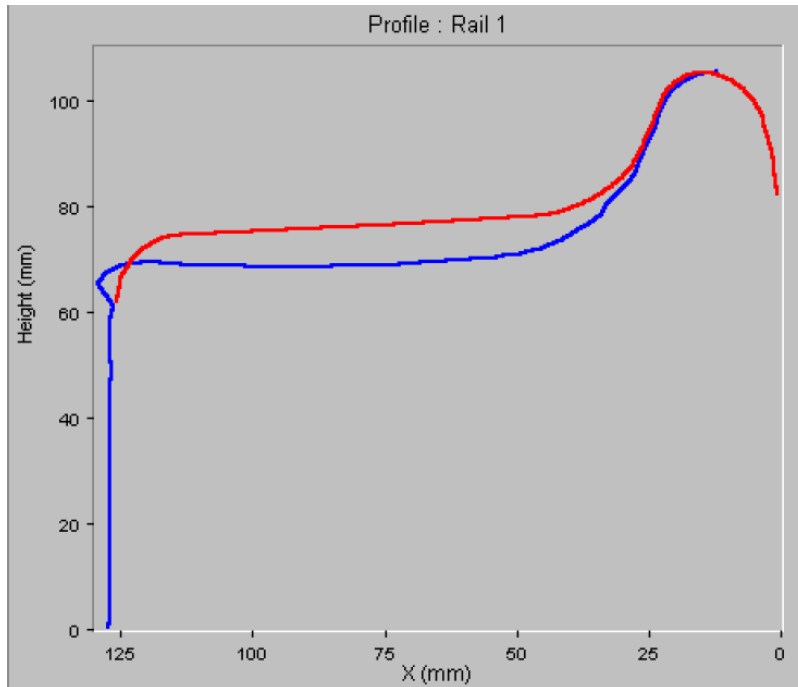
There are various types of high-speed camera and laser-based measurement tools which were developed by different manufacturers using digital image processing techniques to measure the wheel profile and brake shoe pad or disk thickness [52].

The Fully Automated Car Train Inspection System (FactIS) is a machine vision inspection technology that uses high-speed cameras and strobe lights installed next to the tracks to capture images of wheels and brake shoes. These images are stored and analyzed in terms of the wheel flange and rim irregularities, as well as evaluating the top and bottom of brake shoe thickness, to determine the extent of uneven shoe wear [52, 67]. Figure 3-23 presents two sample images of wheel profile and brake pad measurements captured by WPMS.



**Figure 3-23. Left: wheel profile measurements captured by WPMS; Right: brake pad measurements by a WPMS detector [71]**

Once the images of wheel profile are produced by WPMS, the details of wheel components in the images are analyzed and compared with the theoretical profile of the reference wheel, and any irregularities are identified by the system (Figure 3-24).



**Figure 3-24. A comparison between current wheel profile produced by WPMS (blue line) and its respective theoretical profile (red line) [71]**

Depending on the severity level of irregularities measured for wheel profile criteria, the flagged wheel can be immediately inspected and fixed, before reaching the maintenance or condemning limits [47]. It should be mentioned that the WPMS systems are classified based on low speed operations (0–7 mph) and high-speed operations (0–75 mph) technologies [9], though it is more practical to capture the wheel profiles at normal train speeds [69, 70].

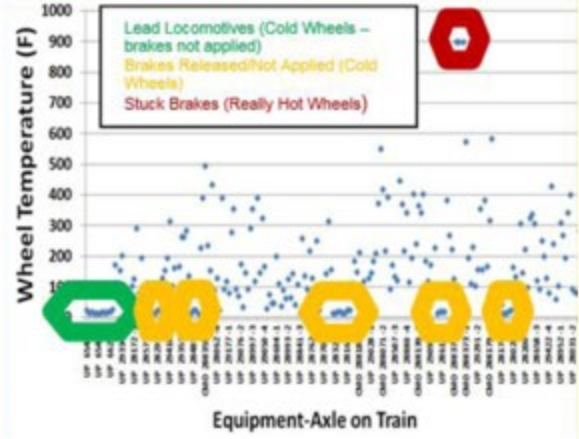
**Table 3-12. Summary of main requirements and specifications of WPMS system**

Criteria	Type	Value	Notes	Ref.
<b>Site Selection</b>	<b>Site size</b>	At least 3 cribs	depends on manufacturer	
	<b>Speed limits</b>	Up to 75 mph	depends on manufacturer	[9, 72]
	<b>Track Requirements</b>	Can be installed on any type of tangent track		[47]
<b>Operating Parameters and Detector Technology</b>	<b>Type of Operations</b>	Any type of rail operations		[47]
	<b>Resolution</b>	A minimum of 1/16 un. Resolution across each parameter's normal measurement	For "Hollow Tread:" 1.0 mm resolution	[73]
	<b>Measurement Accuracy</b>	0.005 for measurements in inches, and 0.5 for measurements in mms	depends on manufacturer	[47, 73]
	<b>Temperature</b>			
<b>Data Communication</b>	<b>Communication</b>	Email, SMS, WIFI	Talker (Optional)	[47]
	<b>AEI, RFID?</b>	Yes		[47, 72]
<b>System Thresholds</b>	Various thresholds and tolerances on the wheel profile		Check Appendix 5.1	[73]
<b>Action Plan</b>	Inspect the train according to dispatcher			
<b>Calibration, Maintenance</b>	<b>Calibration Frequency</b>	Once every 3 years	Auto-calibration can be set on detector	[72, 73]
	<b>Maintenance Frequency</b>	NA		

### 3.11 Wheel Temperature Detector (WTD)

WTD is a wayside detector system used to scan the outer surface of railcar wheels and record temperature for each wheel passing the detector by using infra-red scanning technology. By determining the temperature of wheels, it can indicate whether brakes applied when they should not or applied when they should. As of 2013, approximately 700 WTD are installed in the freight network [7].

The WTD system uses similar technology and algorithms as the HBD system to analyze the wheel temperature distribution throughout the train. As result, stuck brake shoes, unreleased hand brakes, and inoperative valves can be identified using WTD. These are found from wheel temperatures that are greater than (or less than) the wheel temperatures in the rest of the train (Figure 3-25) [8, 54].



**Figure 3-25. An example of WTD for brake effective tests (left); (right) Wheel temperature variation on a train indicating braking condition [8]**

According to AAR standard S-6031, the WTD should be able to capture the cold and hot wheels on a car based on evaluating four different criteria as below [41]:

- **Truck temperature ratio:** which can be determined based on Equation (1)
- **Wheel temperature:** the absolute or average temperature value of a given wheel (depending on the condition that is assessed)
- **Sufficient wheel heat for testing:** means the wheel heat is high enough to ensure that the train is braking and thus, a lower temperature condition of particular wheels demonstrates a poor braking performance.
- **Sufficient lack of wheel heat for testing:** means the wheel heat is low enough to ensure that the train is not braking and thus, a higher temperature condition of particular wheels demonstrates a poor braking performance.

The truck temperature ratio is a primary parameter which can be used in combination with other criteria to detect hot or cold wheels through a train. This parameter can be determined using Equation (1) [41]:

$$T_{tr} = \frac{1}{N} \sum_{i=1}^N \frac{T_{w,i}}{T_{e,i}}$$

Where

- $T_{tr}$  = Truck temperature ratio
- $T_w$  = Wheel temperature from wayside detector
- $T_e$  = Expected wheel temperature
- $N$  = Number of wheels on a given truck

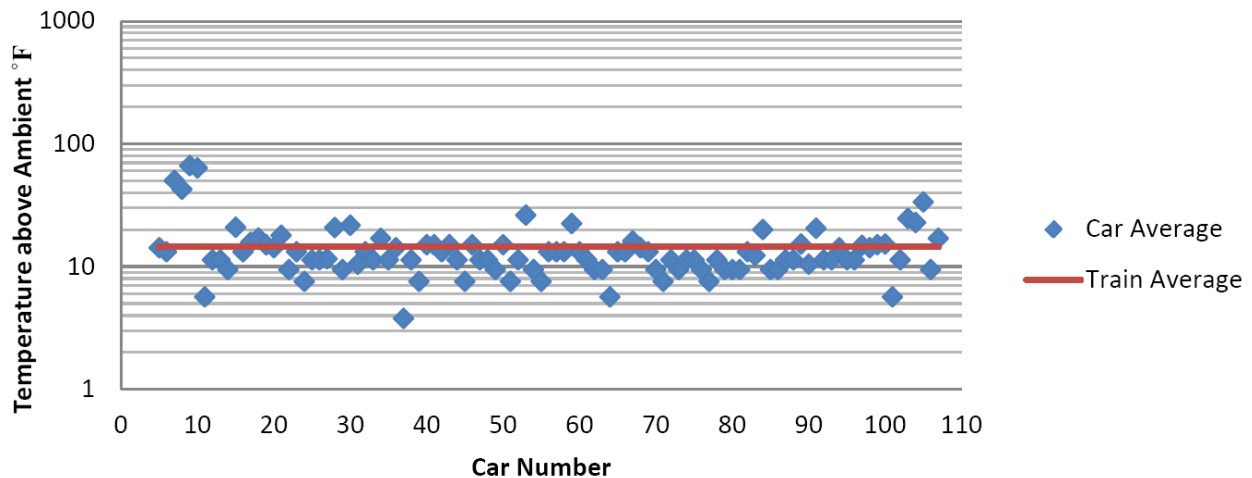
For instance, according to AAR standard S-6031, an inoperative brake from insufficient brake application can be determined on a car, under one of the following circumstances [41]:

- Any truck on the car has a truck temperature ratio less than 30 percent and sufficient wheel heat for testing exists as described in the AAR standard S-6031.
- One or more wheel temperatures on the car are less than or equal to 70 °F and more than three standard deviations below the average for the train side, and sufficient wheel heat for testing exists as described in the AAR standard S-6031.

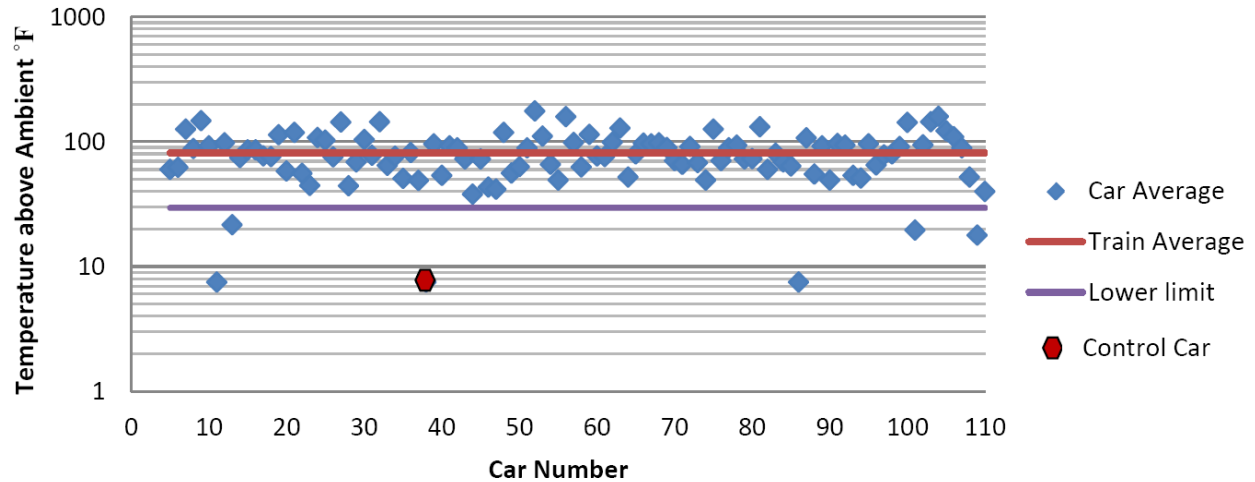
Another example of WTD practices would be to determine an inoperative brake from insufficient brake release on a car under one of the following circumstances [41]:

- Any truck on the car has a truck temperature ratio greater than or equal to 200 percent, and sufficient lack of wheel heat for testing exists as described in the AAR standard S-6031.
- The average value of the wheel temperature minus the expected wheel temperature, divided by the inter quartile range of the train side, for all wheels on any single truck on the car is 3.0 or more.
- One or more wheel temperatures on the car are greater than or equal to 200 °F and more than three standard deviations above the average for the train side.

Figure 3-26 and Figure 3-27 present wheel temperatures of two test trains in “Non-braking” and “Braking” status, which were measured by a WTD system on Class I main tracks through research sponsored by FRA [71]. As shown in Figure 3-26, there are a few cars with high temperatures over the average temperature of the given train that was supposed to be in non-braking status, demonstrating poor braking performance on these detected cars. On the other hand, Figure 3-27 shows certain cars with lower wheel temperature than the average temperature of the given train that was supposed to be in braking status, demonstrating inoperative brake components or a brake system malfunction on these cars [52, 71].



**Figure 3-26. Wheel temperature on different cars of a test train in “Non-braking” status using WTD [71]**



**Figure 3-27. Wheel temperature on different cars of a test train in “Braking” status using WTD [71]**

According to another study conducted by the TTC, the average wheel temperature is associated with the air brake valve performance and its major components as presented in [Table 3-13](#).

**Table 3-13. Wheel temperature standard deviation associated with body rigging or hand brake [51]**

Statistic	Component or Sub-system		
	Valve/Body Rigging/ Hand Brake	Inter-Truck Rigging	Truck Rigging
Mean	0	0	0
Standard Deviation, $\sigma$	88 °F	26 °F	48 °F
Maximum	382 °F	140 °F	268 °F
Max / $\sigma$	4.34	5.4	5.6
Minimum	245 °F	-140 °F	-314 °F
Min / $\sigma$	2.8	5.4	6.5

As presented in [Table 3-13](#), the largest standard deviation, 88 °F, is associated with the valve of the brake system, body brake rigging or hand brakes [51].

To detect cold wheels (and trucks), the WTD systems should be installed on or at the end of a descending grade where the brakes should be applied to a sufficient degree and long enough period to generate heat between wheels and brake shoes or pads.

To detect hot wheels due to stuck brakes or hand brakes left applied, the system should be installed far from any downgrades or any track segments requiring a normal brake application [41].

**Table 3-14. Summary of main requirements and specifications of WTD system**

<b>Criteria</b>	<b>Type</b>	<b>Value</b>	<b>Notes</b>	<b>Ref.</b>
<b>Site Selection</b>	<b>Site size</b>	Either at the end of downgrades (cold wheel detector), or far from the braking zone of track (hot wheel detector)		[45]
	<b>Speed limits</b>	Up to 300 mph	depends on manufacturer	[10]
	<b>Track Requirements</b>	Can be installed on any type of tangent track		
<b>Operating Parameters and Detector Technology</b>	<b>Type of Operations</b>	Any type of rail operations		
	<b>Resolution</b>	± 1 k	depends on manufacturer	[41]
	<b>Measurement Accuracy</b>	± 3 k	depends on manufacturer	[41]
	<b>Temperature</b>	(-40) °F–160 °F	depends on manufacturer	[39]
	<b>Sensor Technology</b>	infra-red scanning technology		[10, 45, 74]
<b>Data Communication</b>	<b>Communication</b>	Email, fax, WIFI	Talker (Optional)	[10, 39]
	<b>AEI, RFID?</b>	Yes	Can be combined	[10, 39]
<b>System Thresholds</b>	<b>Truck temperature ratio</b>	Various values, such as < 30%; ≥200%;		[45]
	<b>Wheel Temperature</b>	Various values such as ≤70 °F; ≥200 °F; Can measure up to 1, 200 °F		[10, 45]
	<b>Sufficient (lack of) wheel heat for testing a cold/hot wheel</b>			[45]
<b>Action Plan</b>	Inspect the train according to dispatcher order			[45]
<b>Calibration, Maintenance</b>	<b>Calibration Frequency</b>	At least once every 3 years	Auto-calibration can be setup	[17, 41]
	<b>Maintenance Frequency</b>	NA		



## 4. Case Study: Wheel Impact Load Detector (WILD)

---

WILD is used in this guide as one of the best documented examples of wayside detector systems that can improve the safety of rail operations, as well as enhance the maintenance practices of both rolling stock and track structure components. This section reviews more details and information regarding the WILD system components, implementation criteria, system thresholds, and WILD calibration and maintenance requirements.

### 4.1 Functionality, Benefits and System Components

The WILD system can provide an analysis of several types of loads that can be considered in track structure and wheel-rail interaction analysis [75]:

- **Static:** The weight of the rail vehicle when it does not move.
- **Quasi-static:** The combined static load and the effect of static load at speed, independent of time parameter. The quasi-static load can be measured in curved tracks when the train generates additional loads onto the rails due to centripetal force and frictional or creep forces.
- **Dynamic:** The additional load due to effects of wheel/rail interaction parameters including time-dependent track component response as well as inertia, damping, stiffness, and mass variables.
- **Impact loads:** Additional loads due to wheel irregularities (such as shelling, flat spots and built up tread) that also create high loads on the track structure.

#### 4.1.1 WILD System Functionality

The main purpose of the WILD system (and other similar systems) is to detect and monitor the dynamic and impact loads of the rail vehicles while they are moving on the track, though they can collect the static and quasi-static loads as well.

When a wheel irregularity generates a vertical load that is high compared to the normal wheel loads (e.g., higher than 90 kips), it is considered to cause damage to equipment and track structure components. In extremely high load cases ( $\geq 140$  kips) it may not be safe to continue operations at normal speed and the train might be directed to proceed at a reduced speed to the nearest siding or yard to set out the car with high impact wheels.

The high impact loads (peak loads) are typically generated by wheels that have a flat spot on the tread surface, which are often caused by a hand brake not released, or by locking brakes (slip-slide). Since the wheel cannot rotate while the hand-brake is engaged (or locking brakes), the wheel-rail friction can deform the surface of the wheel tread to become flat instead of round [73]. In addition to a flat spot, other wheel irregularities such as shell spots, and high flange may also cause high impact loads.

The first application of the WILD system in the U.S. rail environment was in the early 1980s on the Northeast Corridor (NEC) when Amtrak inspectors were confronted with numerous transverse rail seat cracks on their relatively new concrete crossties. The investigation revealed that these cracks were caused by high peak vertical loads (up to 100 kips) generated by wheel tread irregularities (long wavelength out-of-round conditions) on Amtrak cars in such a way that

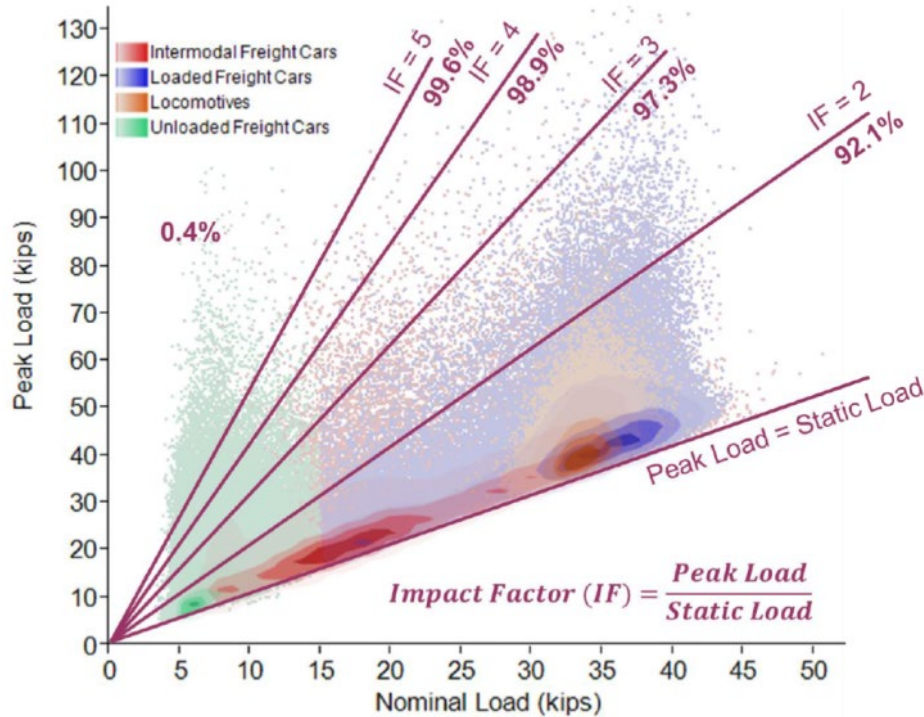
these irregularities could not be detected through normal visual inspection or regular wheel geometry inspections. As a result, Amtrak and FRA funded a project to develop the first WILD system to be installed on NEC near Edgewood, MD, to detect wheels with high loads to prevent further potential damage to the track structure, including tie life cycle and wheelsets [77].

After the WILD system implementation on the NEC corridor, Amtrak reported a significant reduction in axle bearing issues (from once a month to once every 6 months), which might be caused by high impact loads. Consequently, accidents due to bearing failures were decreased along this corridor as well [78]. This successful WILD implementation created an impetus in the industry to adopt the detector system for wide freight network use led through further research by the AAR in 1990s.

High WILD loads can be presented as forces (kips or kN) or as Impact Factor or Dynamic Ratio (DR) (peak load divided by static load). The peak loads are typically within a range of 50 up to 140 kips, while the impact factor is typically calculated between 1 and 5. For instance, an impact factor of 2 means the peak load of the given rail vehicle is twice the static wheel load, e.g., 60-kips peak load for a 30-kips static load.

Figure 4-1 demonstrates an example of peak loads versus the nominal loads collected by a WILD system installed in a Class 1 railroad network. The various impact factors are shown as lines demarcating the peak to static load ratios for the data. The percentages indicate the cumulative number of ratios that appear in that zone and the lower zones. However, the 0.4 percent number shown in the figure is different because it is the number of ratios appearing at or above an impact factor of 5 in this zone, rather than the cumulative number of ratios shown elsewhere in the chart.

Note that since 2002 all WILD detectors in the U.S. rail network are included through a central data repository system known as Equipment Health Management System (EHMS) that allows sharing the collected data among the authorized freight railroads as well as rail shippers, rail vehicle manufacturers, and car owners for further maintenance decision making [1].



**Figure 4-1. Relationship between static loads and peak loads collected by a WILD system in a Class I railroad network, classified for different types of rolling stock [75]**

#### **4.1.2 WILD System Benefits**

There are several benefits provided by a WILD system including improvements to the following [59, 65]:

- Wheel tread life
- Ride quality
- Fleet availability

**And, reduction** in the following:

- Rail fatigue
- Concrete and wood tie damage
- Bearing damage
- Truck damage
- Noise level
- Service interruptions

Although there are always only a few wheels with high impact loads in service, even a small percentage of high impact wheel loads can cause a big influence on the operating costs and safety aspects. For instance, a study revealed that high impact loads may increase the surface crack growth rate on a rail by approximately 100 times compared to low impact loads [76]. Also,

according to another study, there are approximately 2,400 wheelsets per day in North America in which there is a significant impact difference between the 2 wheels on the same wheelset [73]. Such a noticeable difference between two wheel loads may indicate that there is a potential wheel defect on the wheel with the higher impact load.

The WILD system can not only capture high impact loads, it can also improve system efficiency. For instance, it is indicated by MNR, a commuter rail service of Greater New York, that implementation of four WILD systems effectively resulted in a 28 percent reduction in overall impact loads, with the average DR dropping from 2.5 to 1.8 [68]. Another study conducted in Australia revealed that installing a new WILD system could provide a reduction of 90 percent in serious wheel related-irregularities during the first 6 months of WILD operations. The same study also demonstrated that WILD detectors may provide a far earlier warning of bearing failure than thermal ‘hot-box’ systems [77].

There are various wheel tread irregularities that can be detected by WILD systems, such as flat and shell spots. In addition, vertical split rims (VSR) and shattered rims which can cause high wheel loads and even derailment, are among those wheel irregularities that can also be detected by WILD systems [73, 78]. For instance, in a study conducted by TTC, 24 broken wheels were examined and it was confirmed that 71 percent of the time, the wheel failure was caused by a VSR defect. Also, 12 out of these 24 broken wheels had historical WILD data in which 50 percent of them (6 out of 12 wheels) had impact loads that exceeded 90 kips prior to failure [78].

From a financial standpoint, WILD systems can have a significant impact on maintenance and repair costs, due to the fact that wheel-related issues are a major cause of train accidents [78, 82]. According to MNR, applying one WILD system in its network increased the service life of its wheelsets from 2.5 to 3 years. Such improvement could provide an annual savings of \$1.6 million, or \$16 million over 10 years, just in terms of wheelset maintenance cost (excluding any benefits from reduction in damage costs to track and vehicle trucks) [68].

In Australia, the National Rail (NR) operator (currently known as Pacific National) reported that their single WILD system could save between \$1.2 to \$2.8 million each year (1999-dollar value) just in reduction of wheelset failure cost [77].

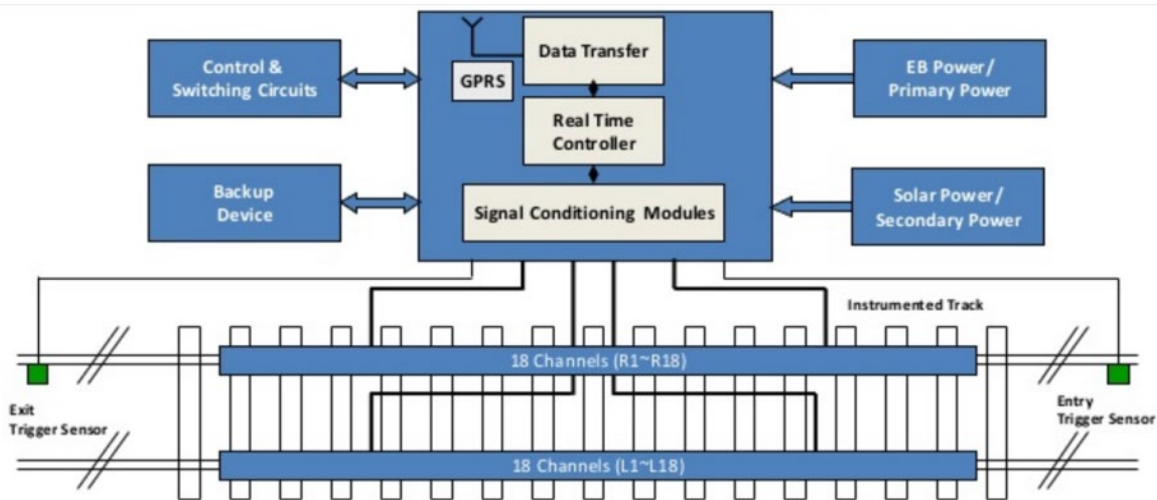
#### **4.1.3 Major Components of a WILD System**

Generally, a WILD system consists of three major components [78]:

- **Instrumented tracks**
  - Train presence sensors (such as accelerometers, strain gages, optical sensors or a combination of them), RFID or AEI tag reader
- **Data logging and processing equipment**
  - Single embedded controller and signal conditioning unit running impact load analyzer software
- **Communication equipment**
  - Wired or wireless data transfer equipment (modem, fiber optic cables, GPRS, etc.), power back up (solar battery, DC or AC power) and calibration setup/features (may or may not be included)

As shown in [Figure 4-2](#), a WILD system gathers signals from sensors (e.g., strain gages installed on the web of the rail in a series of consecutive tie cribs) triggered by passing wheels, sampling approximately 7 to 10 percent of each wheel circumference per crib [77]. The number of cribs instrumented control the so-called “coverage” of various wheel sizes which determines the probability of detecting a wheel irregularity as the wheel passes a WILD site.

All WILD sites are typically equipped with a technical (control) room next to the measurement zone (instrumented track and AEI tag reader) to collect and analyze the respective data, and then to transmit them to the central office or train crew ([Figure 4-3](#)).



**Figure 4-2. Different components of a sample WILD system, based on strain gage technology [2]**



**Figure 4-3. An example of WILD site components developed by L.B. Foster [59]**

There are various types of WILD systems developed by different manufacturers or suppliers around the world using different technologies and components. [Table 4-1](#) presents the main suppliers of different WILD systems.

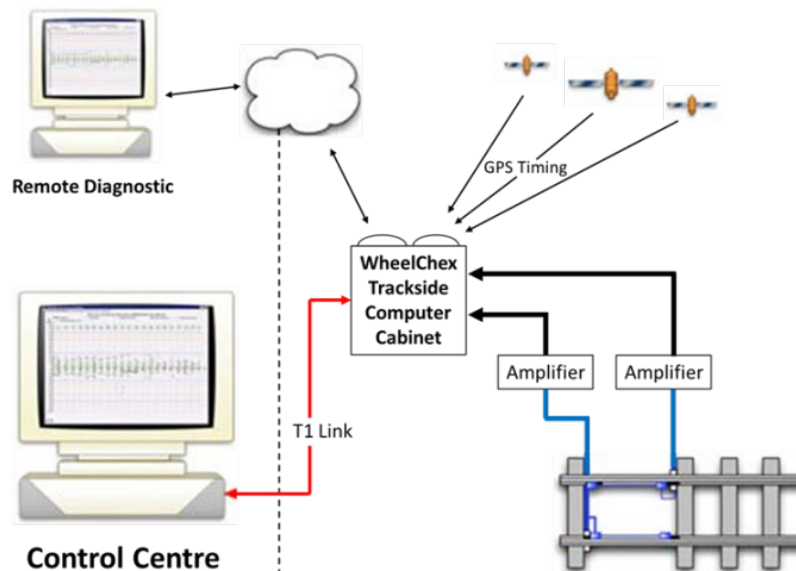
**Table 4-1. List of available WILD suppliers around the world**

Supplier	Product	Headquarter	Notes	References
Ansaldo STS	WILD	Italy	Mainly provided in Europe	[4]
DeltaRail <sup>1</sup>	WheelCheX <sup>®</sup>	UK	Mainly provided in UK, Spain, and US	[67, 68]
L.B. Foster <sup>®</sup> Salient Systems	WILD	USA	Primary manufacturer of WILD systems in North America (over 190 systems installed in the US)	[59, 74]
MERMEC	WILD	Italy	Mainly provided in Europe	[9]
NagoryFoster	WILD	India	- Mainly provided in India and South-Asia - Developed based on Salient's Technology	[80]
Progressive Rail Technologies <sup>2</sup>	WILD	USA	Mainly provided in US (over 15 systems installed)	[63]
Schenck Process	MULTIRAIL <sup>®</sup> WheelScan	Germany	Mainly provided in Europe	[61, 64]
Track IQ	WCM <sup>®</sup>	Australia	Over 50 systems installed, worldwide	[62, 77]
Voestalpine	ATLAS FO	Germany	Mainly provided in Europe	[10, 66]

<sup>1</sup>: Currently, managed by Vortok, part of Pandrol

<sup>2</sup>: Currently, part of "International Engineering and Global Connections"

Figure 4-4 presents the architecture of one of the WILD systems (WheelCheX<sup>®</sup>) including the trackside equipment as well as communication and control center tools.



**Figure 4-4. Architecture of WheelCheX<sup>®</sup> as an example of an available WILD system**

There are a variety of concepts to interpret wheel tread irregularities depending on the algorithm and detection models of the available WILD systems. Two examples of wheel irregularity conceptual interpretation are illustrated in Figure 4-5 and Figure 4-6.



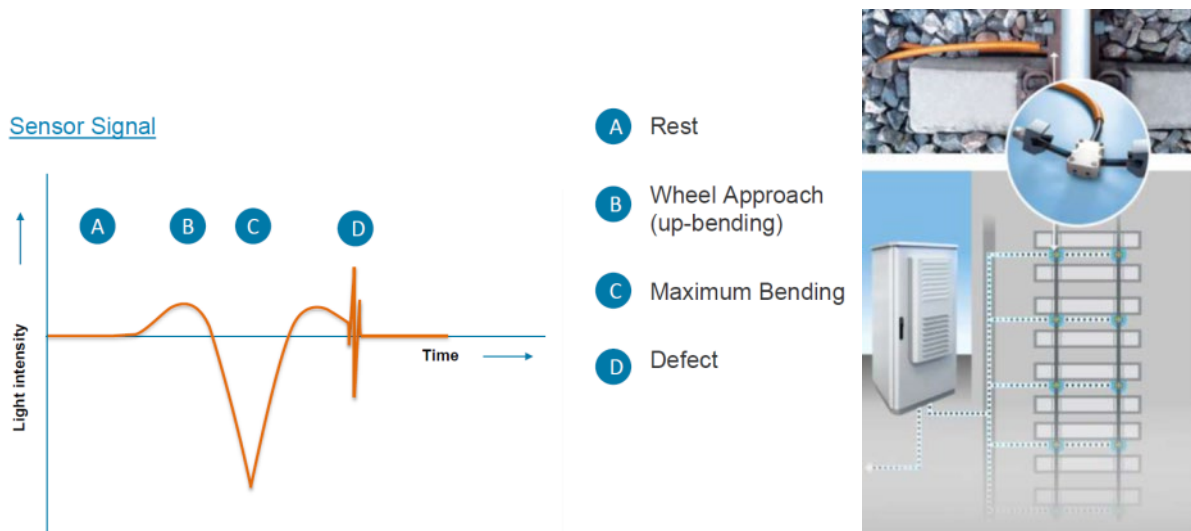


Figure 4-5. Voestalpine's WILD system using optic sensors underneath of the rails [10]

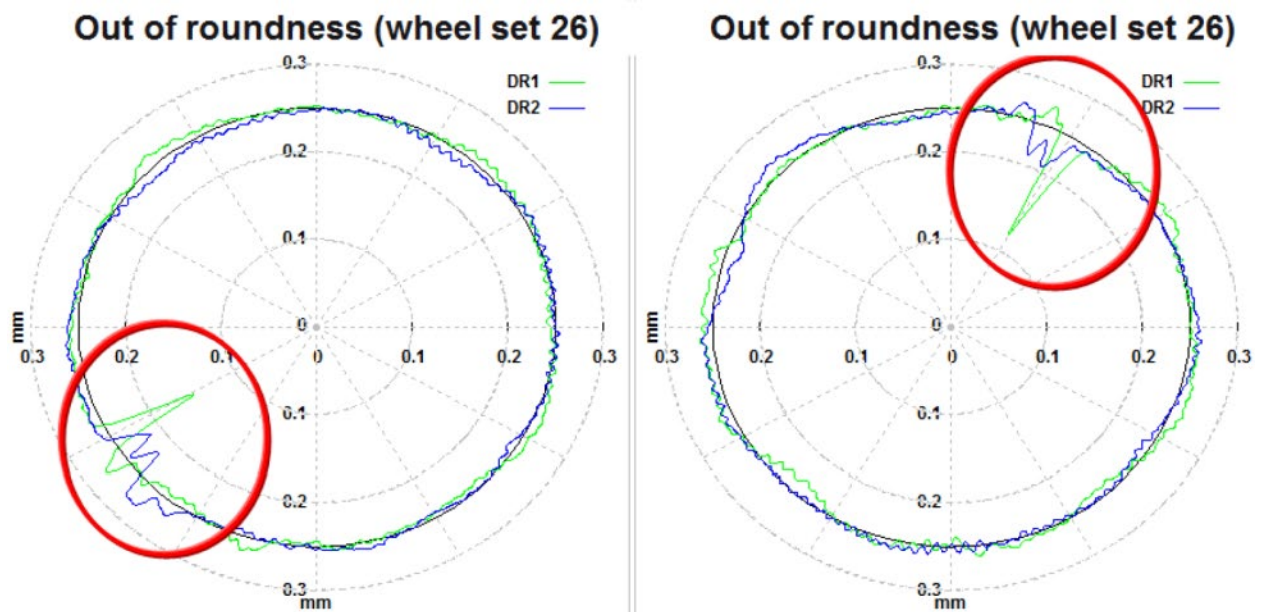


Figure 4-6. An example of wheel tread irregularity detection concept of MERMEC's WILD system using accelerometers and strain gages [9]

#### 4.1.4 Accuracy and Reliability of WILD System

The accuracy and reliability of a WILD system depends on two main factors:

- Technical characteristics of the system, including the type and algorithm of impact load detector and sensors
- The number of WILD systems integrated that can verify the information of other WILD systems



According to AAR’s Field Manual Appendix F-B.1(a) the following criteria should be met for a functional WILD system [1, 29]:

*“Wheel impact load detectors must be maintained such that each rail has at least 70% of vertical circuits active. If less than 70% of the circuits are active on a rail, then the data from that rail does not meet the validation requirements. The average vertical weight for all wheels measured must be calculated for each active circuit. The range (maximum-minimum) of these average weights for a rail must be less than 15 kips for any train set containing 50 or more axles. If the range is greater than 15 kips, then data from that rail does not meet the validation requirements.”*

**Table 4-2. WILD system thresholds to maintain the reliability and precision level of the collected data**

WILD System	Resolution	Speed Limits	Temperature	Sensor Technology	Required Zone	Weight Accuracy	Ref.
<b>Ansaldo STS</b>	11 lb.	> 15 mph	(-4 °F)–140 °F	Fiber optical clamps on rails	NA	2%	[4]
<b>DeltaRail<sup>1</sup></b>	NA	NA	NA	Strain gages on the rail	NA	10%	[67, 68]
<b>L.B. Foster<sup>2</sup></b>	100 lb.	30–180 mph	32 °F–131 °F (Electronics)	Strain gages on the rail	50 feet	NA	[59]
<b>MERMEC</b>	NA	25–125 mph	(-22 °F)–167 °F	Accelerometers and strain gages	35 feet	2%	[9]
<b>Progressive Rail Technologies<sup>3</sup></b>	NA	NA	NA	Strain gages on the rails	NA	2%	[63]
<b>Schenck Process</b>	0.2 mm wheel flat depth	6–155 mph	(-40 °F)–158 °F (Mechanics) 40 °F–86 °F (Electronics)	Strain gages on concrete ties	Approx. 15 feet	2%	[61, 64]
<b>Track IQ</b>	5 mm spall detection	18–155 mph	arctic, tropical and desert environment	Accelerometers and strain gages	20–30 feet	3%	[62, 77]
<b>Voestalpine</b>	NA	> 12 mph	(-22 °F)–158 °F	Fiber optical clamps on rails	Approx. 20 feet	3%	[10, 66]

<sup>1</sup>: Currently managed by Vortok, part of Pandrol

<sup>2</sup>: Including Nagory FOSTER system [80]

<sup>3</sup>: Currently, part of “International Engineering and Global Connections”

NA: not available

In addition, the accuracy of WILD systems can be affected if the system is not properly operated within the thresholds recommended by the respective manufacturers. These thresholds may include the minimum and maximum speed of rail vehicles passing the WILD detector, the environmental temperature of the WILD location, the stability of track structure, etc. [Table 4-2](#) summarizes some of the characteristics and technical thresholds of different WILD systems (or similar products) that can affect the system reliability and demonstrates the accuracy level of different WILD systems available in the market.

In addition, other parameters may cause variation in readings from one pass over the WILD system to the next due to [77]:

- Progression in an existing or a new irregularity created after the first reading

- A narrow wheel-rail contact area
- Sharp edged, very small irregularities near the edge of the normal wheel-rail contact area
- Irregularities with a ‘resonant’ speed, usually well over 50 mph, in a way that wheel-rail contact may become momentarily zero. Thus, the collected data can be affected by the way the wheel ‘lands.’
- When a vehicle is turned around or a train reverses over a WILD array, it may aggravate the irregularities; particularly it may increase the asymmetric defects.

#### **4.1.5 WILD Database Management**

##### **4.1.5.1 Data Processing**

Generally, the data collected by WILD wayside detectors can be processed using one of three different approaches:

- On-site processing
- Remote (central office) processing
- Combined approach

The on-site processing approach relies only on the diagnostic and interpretational models located in the control room next to the instrumented track. The remote processing approach uses a computer model and scripts that are managed from a distance, typically located at a central control office, to manage the data from all WILD and even other wayside detectors. The combined approach takes advantage of both models. It may generate some basic reports and temporary results using the on-site processing method, followed by more comprehensive and advanced reports using remote (central office) computational tools. For instance, L.B. Foster, a manufacturer of WILD systems, uses a combined processing approach. First it deploys microcomputers at a control room “*to sample the analog strain gage amplifier signal output and determine the peak wheel load from each passing wheel,*” Then a master computer is remotely used for post-train passage analysis [77].

It should be noted that AAR’s InteRRIS® database system is considered a combined data processing system in which all raw and processed data of individual WILD detectors are warehoused under InteRRIS® to be further analyzed and studied by respective railroaders.

##### **4.1.5.2 Data Storage**

Each time a train passes the WILD site, a large amount of data is collected by the detectors. For instance, assuming a 150-car freight train (600 axles) is passing along the WILD detector at 25 mph, which then requires continuous sampling for 6–8 minutes. For such a train, there will be approximately 100 million data records collected by an eight-circuit WILD system [77].

The collected data can be classified by the WILD system at typically three levels:

- **Train level:** Particularly for transit and commuter rail systems with a pre-determined train consist

- **Vehicle level:** For all types of freight, passenger, and transit cars if they are equipped with identification tags using RFID, AEI or other similar technologies
- **Component level:** Including wheel, axle, and truck components depending on the WILD system capabilities

Typically, the following information is collected and reported by the WILD system [4, 7, 74]:

- Date and time of collected data
- Track number (in case of operating WILD systems on multiple-track corridors)
- Train direction
- Train speed
- Total number of axles
- Identifying the respective wheel, axle, and truck for collected data
- Gross weight of wheel, axle, truck, car, and train
- Dynamic Ratio for wheel, axle, truck, car, and train (average and max.)
- Total train weight
- Total train length

The stored WILD data should match with other available vehicle and equipment database data such as the vehicle AEI tag (RFID), AAR's UMLER<sup>®</sup> database (for verifying the vehicle characteristics such as axle counts, car type, and wheel size) to be used by rail operators [44].

#### **4.1.6 Communication Method**

The WILD system can communicate within its on-site components, and other remote parts, and staff using different technologies such as GPS-based communications, optical fiber, radio, or modem-based systems [7, 10]. All these protocols and communication methods should be reliable and integrated through the entire system. Thus, some of the WILD systems, including products by Ansaldo STS [4] and L.B. Foster [59], were developed to include an auto-diagnostic (self-diagnostic) feature. This feature can routinely check the operating conditions of the individual components of the WILD system and automatically detect and report sensor failures as well as measure equipment failures, including on-site processing and back office system failures [4].

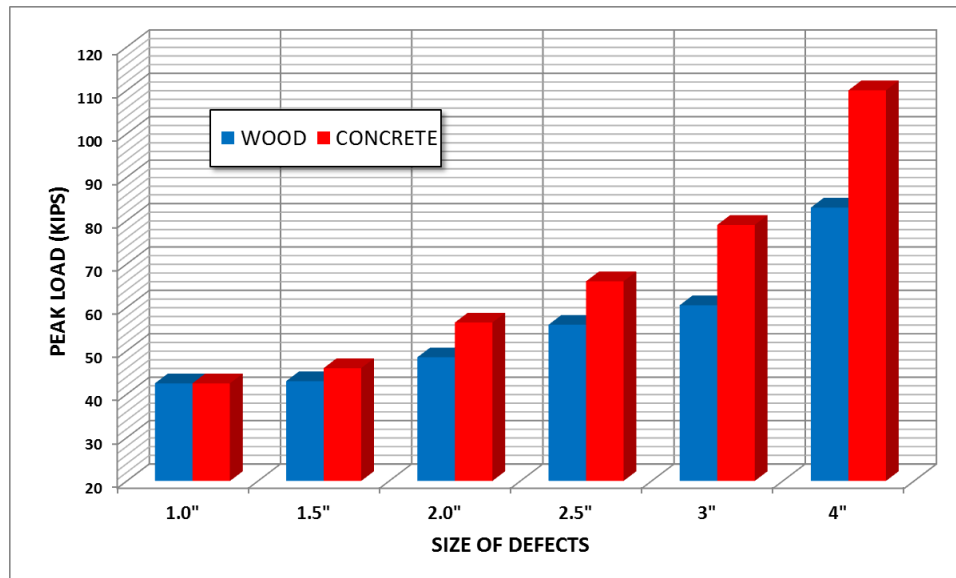
#### **4.2 Site Selection Criteria of WILD System**

As explained earlier in [Section 2](#), there are several criteria and features for installing a new wayside detector system, including for WILD systems, which should be considered when studying the location of new system. This section briefly reviews the primary criteria regarding new WILD system selection and system installation.

### 4.2.1 Track Characteristics

Depending on the type of WILD system and the manufacturer recommendations, there are certain track characteristics that are critical when selecting the location of a new system, as follows:

- **Track Components:** Most WILD systems can be installed on ballasted or non-ballasted tracks, either concrete or wooden ties, though some systems are recommended to be installed on concrete ties.
- **Track Geometry Requirements:** All WILD systems are recommended to be installed along a tangent track with no vertical or horizontal curvature immediately located before or after the WILD detectors.
- **Track Structure Requirements:** The WILD system may have location requirements specified by the manufacturer, such as the system may not be located on a bridge on wooden ties (or even slab track), along a grade-crossing, or within the boundaries of switches.
- **Ride Quality:** A new WILD system may not be installed along a location where it can aggravate the vibration and noise levels of train passage, particularly in proximity of urban areas.



**Figure 4-7. Comparison of impact loads on wood and concrete ties at 40 mph, 100-ton cars, and machined flats [69] (recreated chart)**

The characteristics of track components can affect the impact loads recorded by a WILD system. For instance, tracks with concrete ties generally have higher stiffness in comparison to track with wood ties. Thus, according to a study conducted by AAR [30], [Figure 4-7](#), track with concrete ties may generate 15–30 percent higher impact loads in comparison to wood tie tracks, at a given speed and for a given flat spot.

### 4.2.2 Traffic and Speed Coverage

As explained earlier, the location of a WILD system should be chosen to cover as much traffic as possible. Also, the operational speed of the rail vehicles passing along the given location should comply with the speed threshold of the given WILD system recommended by the manufacturer. Studies show that a WILD system can provide better coverage and more precise readings when the system is installed along a track location with the operational speed of the trains in the range of 40 to 50 mph [66, 78].

Note that the measured impact load is directly related to the rail vehicle speed for the range of North American train operating speeds. In other words, the faster trains pass by the detectors, the higher the wheel impact loads will be most likely generated for majority of wheel tread irregularities. For instance, a review of WILD data for a wheel that was involved in a 2013 derailment on CP revealed that seven of the nine impacts detected by the WILD system for the given wheel were measured at speeds between 30 and 42 mph, which were below the recommended speed threshold of 50 mph of CP railroad for measuring the wheel impacts [78]. This underestimated the severity of the wheel irregularity. However, CP adjusts all measured impacts to 50 mph. [Table 4-3](#) presents the relationship between measured and calculated wheel impact loads at different speed levels conducted by CP.

**Table 4-3. An example of measured and calculated wheel impacts at various speeds (source: CP) [78]**

<b>Train speed (mph)</b>	<b>Nominal weight per wheel (kips)</b>	<b>Measured wheel impact (kips)</b>	<b>Calculated wheel impact at 50 mph (kips)</b>
30	33	90	128
35	33	90	114
40	33	90	104
50	33	90	90

In another study conducted by the AAR, several wheels with a given level of wheel irregularities (mainly flat and shell spots) were operated over a WILD detector to evaluate the impact of speed on the WILD readings. The results of this study confirm that a higher speed may generate a higher peak load (impact load) readings by the WILD system for the same wheel irregularity compared to lower speeds as shown in [Figure 4-8](#). The study also showed that higher speeds (e.g., 70 mph) lead to a more scattered range of peak loads and mean load values, compared to lower speeds (e.g., 20 mph), resulting in a higher standard deviation in the WILD readings from different WILD detectors for the same wheels, [Figure 4-8](#) and [Figure 4-9](#).

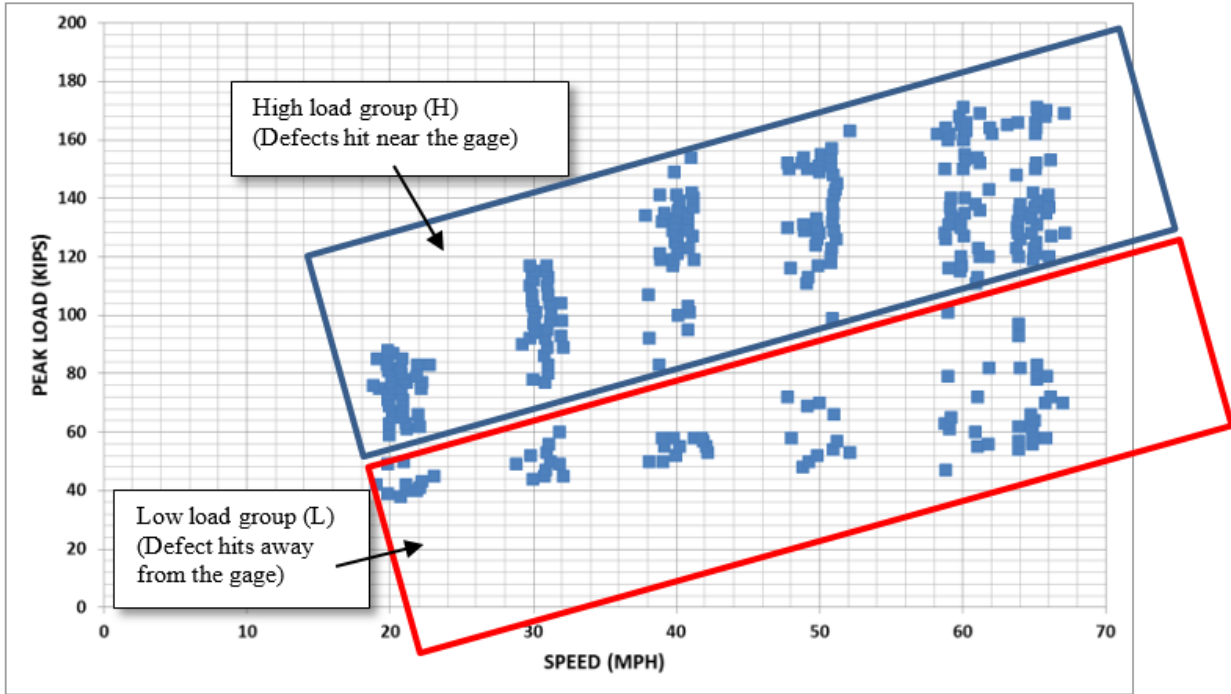


Figure 4-8. Impact load scatter (36-inch diameter out-of-round wheel, single 140 mm divot, 100-ton loaded car [69] (recreated chart)

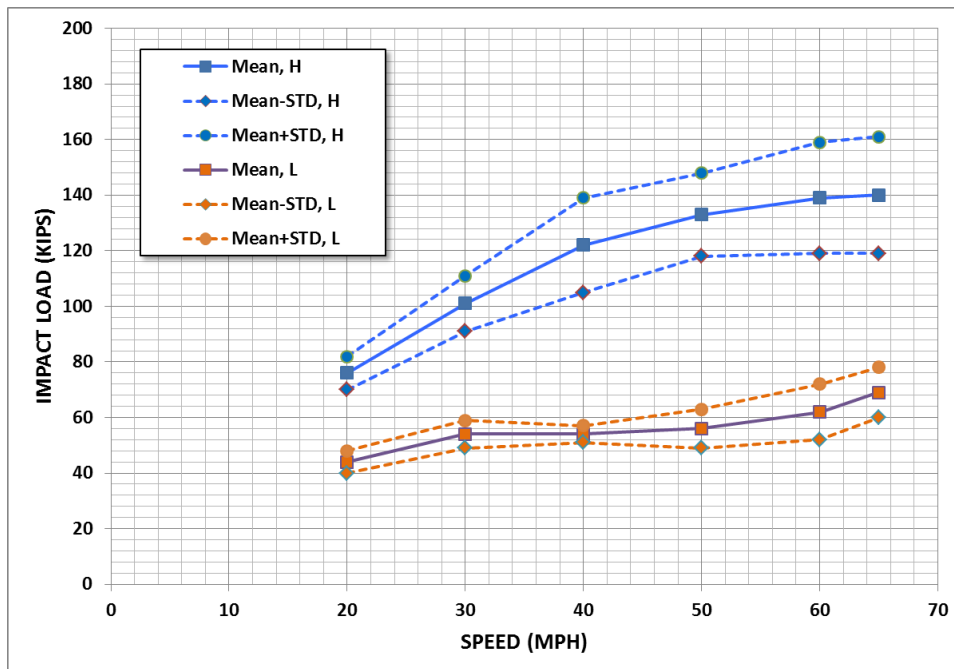


Figure 4-9. Impact load statistics (36-inch diameter out-of-round wheel, single 140 mm divot, 100-ton loaded car [69] (recreated chart)

### 4.2.3 Location Accessibility and Maintenance Features

A new WILD site should be accessible for internal inspection and maintenance activities on the system components. In addition, there should be a rail facility located within a reasonable distance from the proposed location of the WILD site, such that train crew can stop a train to inspect or set out cars flagged by the system, in case a wheel with very high peak loads (or high DRs) was detected, requiring immediate attention.

Also, it is typically recommended to install a WILD system outside of train stop locations (e.g., away from yards, sidings, stations, or hump yard boundaries), which tend to create high variability in operating speeds.

The WILD system may be integrated with other existing wayside detectors such as AEI reader, HBD, DED, THD, and HWD. However, the manufacturer of WILD system may not recommend installation of the WILD system within certain proximity of other existing wayside detectors to avoid any interference with them, or other rail equipment and facilities.

## 4.3 WILD System Thresholds, and Performance Monitoring

### 4.3.1 Data Triggers and Thresholds

The data collected from the WILD system should be analyzed for any further actionable or informative requirements, either automatically by the detector software or by the respective authorized parties (rail operator, car owner, etc.). The analysis should be reported in near real time for those wheel irregularities that can endanger the safety of rail vehicle operations when a high impact load is detected by the WILD system.

The AAR has developed a Field Manual of the AAR Interchange Rules that can be used for analyzing the WILD system collected data. According to Rule 41, the InteRRIS<sup>®</sup> database has four performance indices for WILD systems to flag a wheel for action [7]. The performance indices of InteRRIS<sup>®</sup> database for WILD detector systems are shown in [Table 4-4](#).

**Table 4-4. WILD indices for freight service [7]**

Index*	Description
<b>Final Alert (140 Kips and above)</b>	The operating railroad is <u>required</u> to inspect the train and move it at slow speed (below 30 mph) to set out the affected car for repair.
<b>AAR Condemnable (90–140 Kips)</b>	The operating railroad is <u>required</u> to shop the car for repair as soon as the car reaches destination.
<b>Opportunistic Repair (80–90 Kips)</b>	If a car is shopped for any non-wheel related repairs, the repair facility is permitted to make wheel repairs to eliminate defects causing high dynamic loads and recover the costs from the car owner under AAR’s Interchange Car Repair Billing system.
<b>Window Open (65–80 Kips)</b>	The car owner can choose to shop the car and make wheel repairs to eliminate defects causing high dynamic loads.

\* Association of American Railroads - Field Manual Rule 41(r)

The performance indices shown in [Table 4-4](#) are more applicable for freight traffic since freight rail cars have higher axle loads (and subsequently higher impact loads) than passenger rail



vehicles. Thus, similar performance indices can be defined and used for passenger and rail transit industry based on incorporating the impact load factor (or DR)<sup>4</sup> [1].

Freight railroads may also use the concept of DR (used by passenger and transit services) to capture empty or lightly loaded rail vehicles with defective wheels. In addition to the actionable indices of impact loads recommended by the AAR (90 and 140 kips loads), freight service may also use the following indices based on the concept of dynamic load parameter [1]:

- Dynamic Load increment (over the static load)  $\geq 30$  kips or
- Dynamic Ratio (Dynamic wheel load/static wheel load)  $\geq 3.0$  or
- Peak Impact (dynamic wheel load)  $\geq 65$  kips

Passenger and transit rail service operators typically use the concept of DR due to the small deviation between empty and loaded weights of passenger cars. Table 4-5 presents the actionable thresholds and triggers for WILD systems based on DR criteria that was designed for and operated by MNR commuter railroad.

**Table 4-5. MNR’s decision table for “Actionable” WILD data [1]**

Threshold Level	Dynamic Ratio (MNR Criteria)	Action
<b>Emergency</b>	$\geq 5.00$	Defective wheels addressed immediately
<b>Alarm</b>	<b>4.00–4.99</b> (Loco Wheel: 136,000–170,000 lbs.) (Coach Wheel: 71,000–89,000 lbs.)	
<b>Warning</b>	<b>3.00–3.99</b> (Loco Wheel: 102,000–136,000 lbs.) (Coach Wheel: 53,4000–71,000 lbs.)	Scheduled for timely correction
<b>Information</b>	<b>2.00–2.99</b>	Addressed during normal maintenance
<b>No Notification</b>	<b>1.00–1.99</b>	Information only (Normal operation)

Any other thresholds or warnings set up by rail operators or vehicle owners should be developed and applied in a way that all relevant condemnable thresholds or defect sizes recommended by the AAR, or prescribed in the FRA regulations (or Transport Canada, in case of operating trains through Canadian territory), are met [44]. Thresholds for a new WILD system should be established in consideration with the maintenance shop capacity<sup>5</sup> especially for corridors that have limited shop capacity, such as urban transit or commuter rail systems. Temporary thresholds should be tested for a short period of time to evaluate the ability of the shops to true the number of flagged wheels triggered by the temporary thresholds of the new WILD system.

#### **4.3.2 Decision Flow and Action Assignment**

System integration is part of a successful implementation for any new detector system being installed. In the case of a new WILD detector, the system integration plan should be developed jointly by the departments and entities who are involved in the daily operations, such as:

<sup>4</sup> *Dynamic Ratio: The ratio between the peak dynamic load and the measured static load for a given wheel*

<sup>5</sup> : Number of cars which can be concurrently accommodated at the shops.

- Information technology and operation management database center
- Track and rolling stock maintenance and inspection planning
- Train control and signaling systems, particularly for any commendable action identified by the detectors

According to Rule 41 of the AAR Field Manual, the following actions should be considered when determining steel wheel defects:

**1. Condemnable at Any Time:**

*Wheel Out-of-Round or 90,000 Pounds (90 kips) or Greater Impact.*

*(1) Detected by a wheel impact load detector reading 90,000 pounds (90 kips) or greater for a single wheel. The detector used must meet the calibration and validation requirements of Appendix F. The detector must reliably measure peak impacts and must provide a printable record of such measurements. Device calibration records must be maintained. Wheels with condemnable slid flat spot(s)<sup>6</sup> are handling line responsibility and must not be billed otherwise.*

**2. Condemnable When Car Is in Shop or Repair Track for Any Reason**

*Detected by a Wheel Impact Load Detector reading from 80 kips to less than 90 kips for a single wheel. The detector used must have been calibrated per Appendix F. The detector must reliably measure peak impact and must provide a printable record of such measurements. Device calibration records must be maintained. Wheels with condemnable slid flat spots are handling line responsibility and must not be billed otherwise. This will be considered an Opportunistic Repair for the repairing party.*

Additional examples of decision flow and action assignments are explained in following part (Section 4.5), based on experiences reported by CN, CP and MNR railroads.

**4.3.3 WILD Data Monitoring**

Monitoring the status of the wheels with sub critical irregularities can prevent unexpected and dramatic failures in the future, especially if a growth trend is identified by analyzing the time history of maximum wheel loads. The car owners can monitor wheels under empty car conditions as well as using other criteria, such as DR and dynamic increment. For instance, according to AAR Rule 41 for freight rail operations, a DR greater than or equal to 3.0 and a dynamic increment greater than or equal to 30,000 lbs. can be flagged for car inspection and repair [1].

The procedure for monitoring the status of the wheels may or may not be automatically handled by the WILD systems available in the market. Thus, additional models and manually defined algorithms might be needed to frequently monitor the impact load trend of queried cars. This section briefly reviews some primary aspects of WILD data monitoring that can be applied in both freight and passenger rail operations. More examples of WILD data monitoring conducted by rail industry are presented in Section 4.5.

---

<sup>6</sup>Slid Flat:

a. 2 inches or over in length.

b. 2 or more adjoining spots each 1½ inch or over in length.

#### ***4.3.3.1 System Monitoring on WILD Assigned Actions***

Rail operators and car owners or shippers may have a different Asset Management System (AMS) or Inspection Management System (IMS) to monitor their rolling stock health status before and after applying any maintenance or inspection activities.

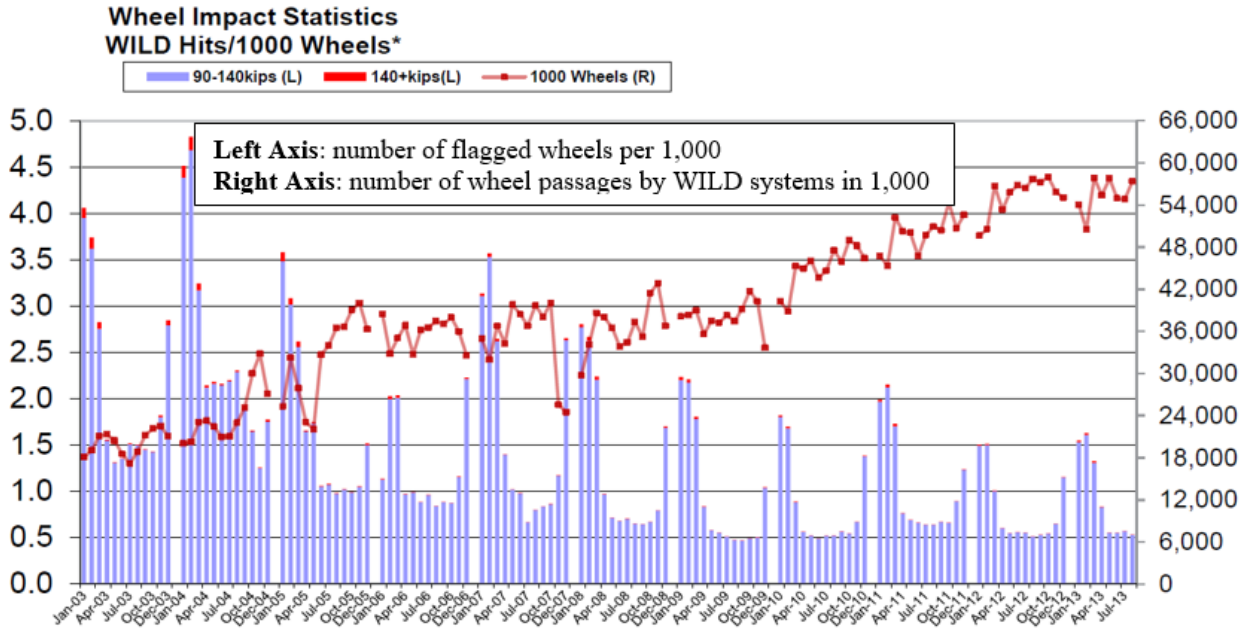
As previously mentioned, wheels with high impact loads can be again flagged in future WILD measurements with even higher impact loads or more serious wheel irregularities, even if they have been set out for additional inspection or repair activities [7, 78]. Thus, monitoring the health status of a flagged wheelset after conducting the proper action can be beneficial to develop a trend-based process wherein repair histories of fleet vehicles can be reviewed for further inspection or maintenance activities. Such a monitoring system can help rail maintenance crews ensure that the remedial action corresponding to the WILD alerts was effective in correcting the problem.

#### ***4.3.3.2 Monitoring Seasonal Patterns***

Monitoring the data collected by WILD detectors can help railroad operators and maintenance departments investigate high wheel impact loads caused by seasonal patterns.

As shown in [Figure 4-10](#), since implementation of WILD systems across North America's rail network, the incidences of high wheel impacts have decreased, while both rail traffic and the number of WILD detectors have gradually increased. Also, the diagram demonstrates that overall there are more wheel impacts observed during the winter season (December, January, February, and March) of each year compared to the rest of the year. However, the overall incidences of winter peak loads were reduced from 7 per 1,000 to 2 per 1,000 wheels inspected over the 2003–2013 period [8].

Another study conducted in Finland also confirmed that the incidences of high wheel impacts increased during winter months (December–February) in comparison to the rest of the year [81].



**Figure 4-10. Rate of WILD readings (per 1,000 wheels) and seasonal effect in North America during 2003–2013 [8]**

#### **4.3.3.3 *Sharing WILD Data with Other Parties and Rail Authorities***

WILD data must be shared between the owner of the track operated on and any other railroad operating over this track. Sharing WILD information is beneficial for both parties on account of:

- The host railroad can review and integrate the history of WILD database of other operators’ cars with its own WILD database, such as AAR’s InteRRIS<sup>®</sup>, to pay extra attention to those cars that have been previously flagged with certain impact loads.
- If the host railroad captures any high impacts on another operator’s rail car, sharing such information through an integrated WILD database system can facilitate and improve the future wheelset maintenance, repair and inspection activities.

#### **4.3.3.4 *WILD Alerts Closure***

As described in previous sections, generated alerts and condemnable actions should be monitored for proper responses to be taken. Following appropriate action by the respective authorities or maintenance crews, the alerts should be closed and archived for future reference. For instance, the data summaries developed by L.B. Foster can either be closed manually when an appropriate repair or inspection is reported, or they can be closed automatically based on the criteria presented in Exhibit 69 of L.B. Foster’s manual [50].

In the case of integrating the WILD system under the EHMS platform, it should be noted that the alert data and the alert state (open or closed) are always available to all EHMS users. For all other raw and processed data, EHMS utilizes UMLER<sup>®</sup>, a tool integrated under the EHMS system, to display the details of requested information after validating the ownership and maintenance status. Similarly, the details on alert closure information are also restricted, but the authorities who are performing or reporting the condemnable action always have access to their closure reports [50].

If an action (repair, replacements, inspection, etc.) was not correctly reported, the closure can be deleted by a qualified and authorized party defined in the system. It should be noted that deleting a closure will re-open the reported alert unless another repair action would address the issue, which closes the alert [50].

#### **4.3.4 WILD Data Trending and Advanced Analysis**

In addition to monitoring the WILD data for improved efficiency levels for tracking the wheel irregularities and monitoring the health status of the rail fleet, certain long-term trends can be also extracted from studying the WILD data. For instance, some studies show that skids (or flats) can become worn at the edges, but then can sharpen again at the next heavy braking application. Such flat spots tend to skid more easily, and it is especially common on locomotives [77].

Another study [73] examined the balance between the impact loads of a wheel pair on the same axle, which can be highlighted as one of the long-term trending aspects of a WILD system. The study focused on the issue that typically failed wheels and their mate wheels have a significant difference between their impact load readings (approximately 2,400 wheelsets per day in North America). Thus, this study hypothesized that removing wheels with a high difference in their load readings may capture failed wheels. However, removing such wheels may not be the most cost-efficient alternative [73], because another study demonstrated that approximately 12 percent of high loads were caused due to imbalance loads on the left and right wheels, and not related to the wheel irregularities [78].

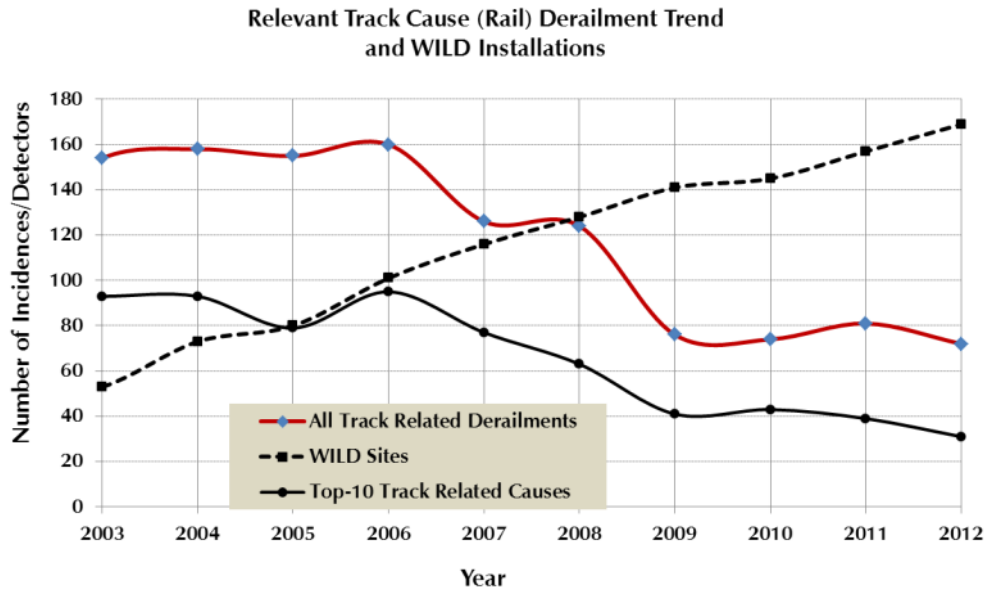
This section briefly reviews some of the long-term trends of analyzing the collected WILD data that are indirectly related to the wheel irregularities. Capturing such issues can eventually reduce the operating disturbances, financial costs, and environmental damages of railroads.

Similar to the previous section, more examples of how railroads conduct WILD data trending are provided below.

##### **4.3.4.1 Impact of WILD System on Track Related Derailment Reduction**

Rolling stock (equipment) and track-related irregularities are two major causes of train derailment accidents. The rolling stock related issues can be typically detected using other technologies of wayside detector systems such as HBD, TPD, and THD, rather than WILD system. However, there are more opportunities to prevent track-related derailments by using WILD systems. To analyze the long-term trend of applying WILD for track-related derailments, queries were collected and classified for the WILD systems that have been in service throughout the national freight rail network during the period 2003–2012.

Figure 4-11 presents the overall trend of the number of WILD systems installed during 2003–2012, compared to the annual trend of track-related derailments (including top 10 and all causes combined). As shown in Figure 4-11 the number of WILD systems has grown from 53 in 2003 to 169 in 2012 (219 percent growth), while the number of track-related derailments has reduced from 154 in 2003 to 72 in 2012 (reduction of 53 percent). The overall trend for the top 10 track-related causes is similar and shows a reduction in derailments from 93 to 31; a reduction of 66 percent. This comparison indicates that the WILD system decreased the number of track-related derailments during the period of 2003–2012 data collection [7], with the potential to further reduce derailments as more WILD sites come on-line.



**Figure 4-11. Impact of WILD installations on track cause related derailments [7]**

By evaluating the WILD data on a given wheel, it is recommended to inspect the given wheel for any further proper action (removal, speed reduction, etc.) if there is any trend in increasing the impact loads for the given wheel. The reason behind such a recommendation is that there may be a correlation between elevated WILD data and wheel or track related irregularities in a way that can cause serious rail accidents including train derailments [78].

#### 4.3.4.2 *WILD System Performance vs. Wheel Maintenance Actions*

Another aspect of WILD system trending would be a comparative analysis between flagged wheels captured by WILD detectors versus the status of inspection and maintenance records applied on the same wheels in the shops. Such comparative analysis could evaluate the performance of a WILD system in terms of any correlation between WILD detection status and respective maintenance actions applied on the same wheels in the shops. Generally, Receiver Operating Characteristics (ROC) methodology can be used to justify the functionality of a given WILD system. Four primary conditions of applying ROC method between WILD detection and maintenance actions on the same wheels can be hypothesized as below:

- **True Negative:** A wheel on a given car “**was not flagged by WILD,**” and the car “**was not repaired in the shop**” within a reasonable time horizon.
- **True Positive:** A wheel on a given car “**was flagged by WILD,**” and the car “**was repaired in the shop**” within a reasonable time horizon.
- **False Positive:** A wheel on a given car “**was flagged by WILD,**” but the car “**was not repaired in the shop**” within a reasonable time horizon (known as Type I error).
- **False Negative:** A wheel on a given car “**was not flagged by WILD,**” but the car was “**repaired in the shop**” for causes which could have been detected by WILD system (known as Type II error).



Note that a properly functioning WILD system should not have a relatively high number of false positive or false negative records.

#### **4.3.4.3 Analyzing WILD Performance across Multiple Locations**

It is very common to operate WILD detectors on multiple tracks at a particular WILD site, or across different locations in a way that the data can be compared and analyzed if common locomotives and cars pass the sites.

Although several factors can affect the performance of a WILD system (including number of wheel passages, speed, etc.), comparison between different WILD detectors along a given network can help evaluate the performance of each WILD system, especially if the passing traffic is relatively similar along the given WILD systems (e.g., a commuter rail system or cycle freight trains).

More details of evaluating different WILD detectors are explained in [Section 4.5](#) of this guide based on MNR's WILD data analysis.

### **4.4 Calibration and Maintenance Requirements**

#### **4.4.1 Calibration Method and Frequency**

According to the AAR, WILD systems must be calibrated at least once in a 3-year period [1]. However, manufacturers typically recommend calibration more frequently, which could be every 6 months or once a year [12].

The calibration procedure is typically carried out by using a rail vehicle with a well-known weight such as a locomotive or an empty or fully loaded rail car, making several passes over the site. Vehicles with weights as widely spaced as possible (such as a locomotive and empty car) should be chosen for the calibration procedure. This wide load range will assist with verifying the linearity of the system. Furthermore, these vehicles should be periodically operated over the WILD site(s) to verify that the calibration of the system has not drifted since the previous scheduled calibration [1]. For instance, as recommended in the WheelCheX<sup>®</sup> user instruction manual for MNR calibration purposes, at least 1,000 axles should have passed over each track before the bays of track sensors are equalized [12]. In the case of using non-locomotive vehicles, the empty freight cars or late evening or early morning commuter trains may be used for calibration purposes since they are likely to be lightly loaded or even empty providing a relatively consistent vertical load.

Also, it is recommended the calibration passes be conducted at the same range of operational speed of the daily trains that typically traverse the WILD site.

When a new WILD site is calibrated for the first time, or when calibrating a WILD site following the replacement of any track sensors, it is important to perform the system calibration with the default calibration values as recommended by the manufacturer [12].

It should be mentioned that some of the WILD systems, including ATLAS FO (by Voestalpine), MultiRail<sup>®</sup> WheelScan (by Schenck Process) and WILD (by MERMEC, and Ansaldo STS), may not require running a particular rail vehicle for calibration procedure as these systems claim to be automatically calibrated [4, 9, 10] or provide a high precision level before static calibration [61].



#### **4.4.2 Calibration and Maintenance Procedures**

The AAR Field Manual-Appendix F (page 742), explains the calibration and functional requirements for different wayside detector systems which are installed in the freight rail network. According to this document, the wayside detectors, including WILD system, should be calibrated using the procedure specified by the OEM as described below [1]:

- Static calibration should be applied based on the manufacturer's procedures at installation and, at a minimum, once every 3 years thereafter.
- The calibration procedure should be stored with the calibration record.
- Calibration records should be available upon request.

For instance, MNR's WILD system, WheelCheX<sup>®</sup>, is calibrated and maintained based on the instructions specified by DeltaRail (the system manufacturer) and managed by MNR's Communication and Signal (C&S) department. The C&S crews perform maintenance of the WILD system twice a year and apply the system calibration once a year, which is more frequent than the AAR requirement of once every 3 years. The higher maintenance frequency conducted by the C&S crews of MNR is likely due to more traffic passing over the track and due to the sensitivity to noise.

During maintenance events, MNR remotely collects WILD data for known vehicles, which are used for a system check versus calibration values. The calibration procedure is applied while only one of the four tracks at MNR's WILD site is out of service. Based on the type of calibration method, the measurements of the MNR's WILD system can be within  $\pm 5\%$  or  $\pm 10\%$  of a typical locomotive axle load, which meets or exceeds the claimed accuracy of the DeltaRail WILD system shown in [Table 4-2](#) [1].

As mentioned earlier, the calibration procedure of a given wayside detector may need to be facilitated by additional programming, macros, or specific tools that the WILD manufacturer has provided in advance. For instance, according to the instructions provided for MNR's WILD system, the calibration process of WheelCheX<sup>®</sup> uses certain macros embedded in a spreadsheet containing specific analysis instructions [12].

#### **4.4.3 Use of Collected WILD Data for Improving Calibration Procedure**

As discussed earlier, analyzing different aspects of a wayside detector system including WILD can provide data for determining whether a re-calibration or a maintenance action is required for the WILD components or not. For instance, the collected mean loads of WILD data on a given rail vehicle can be assessed through a long-term analytical approach, to verify the calibration procedure. If the collected data on the given car are not within the expected range of mean load values, then the calibration procedure may need to be investigated. This could be indicative of strain gage drift. More details regarding this subject are explained in [Section 4.5](#).

### **4.5 Examples of Current WILD Experiences and Best Practices**

This section briefly summarizes experiences of selected railroads as best practices regarding operating WILD systems in their networks. The materials covered in this section include examples from both freight railroads (such as AAR, CN, and CP), as well as passenger railroads including MNR.

## **4.5.1 WILD System Action Assignment and Decision Flow**

### **4.5.1.1 CN Experiences**

Currently, CN railroad has developed the following WILD alarm thresholds for measured wheel impact loads over 140 kips [78]:

- Cars with a single measured impact over 160 kips, or 200 kips for a calculated impact, should be immediately restricted with a speed limit of 25 mph. If the train is operated in the inbound direction, the car must be set out at the terminal, but if the train is an outbound train, the car must be set out at the first designated siding. In addition, the car will be bad ordered by a qualified mechanical crew for required repair and inspection services.
- Cars with a single measured impact between 150 and 159 kips should be immediately restricted to 10 mph less than the speed recorded at the WILD site. The Rail Traffic Controller (RTC) will then decide whether the car should be set out at the inbound terminal (if inbound) or at the first designated set-out location (if outbound). If the set-out location is not available, the car can proceed up to another convenient location for set-out but cannot move beyond the next set-out location, where a certified car inspection (CCI) will be issued for the car. The car will be bad-ordered by a qualified mechanical crew for required repair and inspection services.
- Cars with a single measured impact between 140 and 149 kips should be immediately restricted to 5 mph less than the speed recorded at the WILD site. If the temperature at the WILD site is -13 °F (-25 °C) or colder, the speed reduction must be 10 mph less than the speed recorded at the WILD site. The RTC will then decide whether the car should be set out at the inbound terminal (if inbound) or at the first designated set-out location (if outbound). If the set-out location is not available, the car can proceed up to another convenient location for set-out but cannot move beyond the next location, where a CCI will be issued for the car. The car will be bad ordered by a qualified mechanical crew for required repair and inspection services.
- In all above-mentioned cases, the flagged wheel should be replaced before returning the car to regular service.

In addition, CN has developed the following guidelines for handling cars with measured (peak) impact loads between 80 and 139 kips [78]:

- *Cars arriving from interchange to CN with wheel impacts are automatically identified*
- *Wheel set removal between 80 and 89 kips when a car is on a shop or repair track*
- *Automatically identify wheels with impacts between 90 and 139 kips*
- *Wheel impact between 90 and 139 kips is removed selectively according to AAR guidelines at CCI locations*

### **4.5.1.2 CP Experiences**

Similar to CN regulations on WILD action assignments and thresholds, CP requires the following thresholds and action assignments as a WILD alert is generated [78]:

- In the northern Ontario region, a car should be bad-ordered immediately if the wheel impact is measured higher than 130 kips, or the wheel impact adjusted to 50 mph is over 150 kips. For the rest of the CP network, these thresholds are adjusted to 140 kips or 170 kips, respectively, for measured and adjusted wheel impacts. Following the action assignment, the train speed should be reduced, and the flagged car should be set out at the next designated location for required repair and replacement action on the flagged wheelset.
- For adjusted impact loads higher than 90 kips, the flagged car should be bad-ordered as soon as it is empty. Such a requirement allows the car to be normally operated up to its destination and then it can be repaired once it is unloaded. In addition, CP has developed several opportunistic threshold limits for the cars with adjusted impact loads between 90 and 110 kip. In these cases, the car is flagged in CP's car information management system, but similar to the previous situation, it will not be bad-ordered until arrives at its destination without any restrictions. Then, the car can be repaired (with or without removing the flagged wheelset) when operationally convenient.

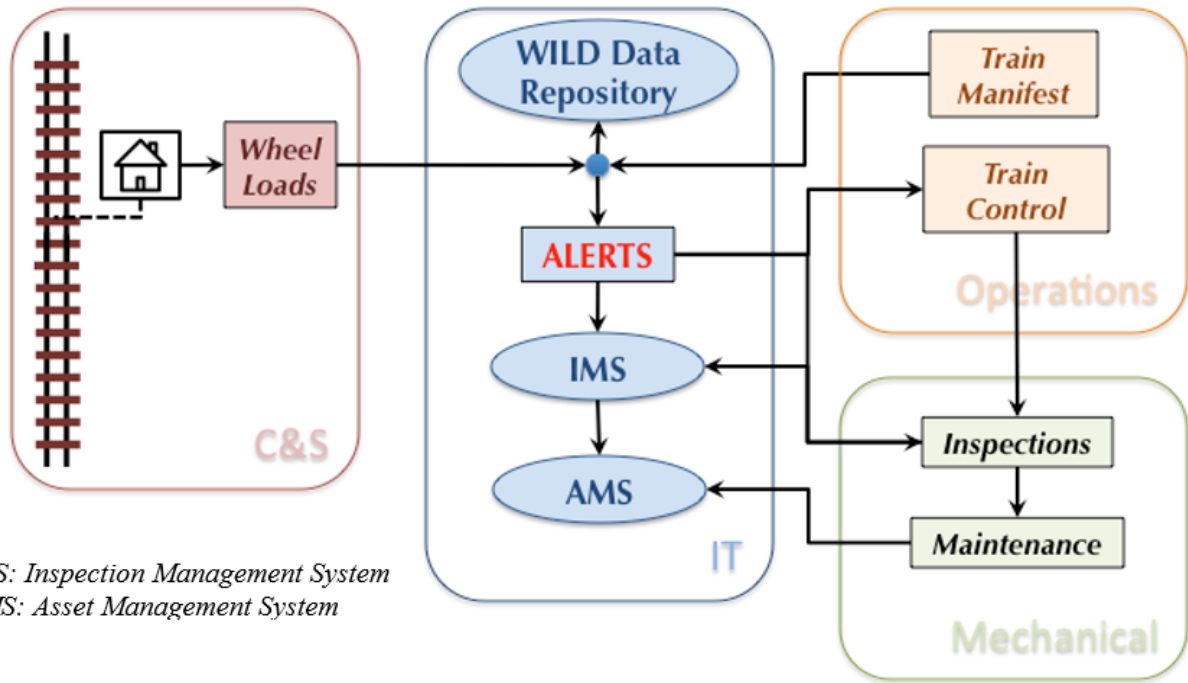
#### **4.5.1.3 MNR Experiences**

MNR, as one of premier commuter rail services in North America, has successfully integrated the operations of their new WILD system across multiple departments via the following [1]:

- The Signals department has implemented and operates the WILD installation
- The Operations department monitors alerts and routes the actions resulting from the alarms
- The Mechanical department handles the resulting inspections and maintenance
- The Information Technology (IT) department has developed, implemented and maintains the email communication chains as well as the data storage

After the data is collected from MNR's WILD detectors, it is processed by the trackside computer to generate a report for every train passing over the WILD site. Then the processed report is transmitted to MNR's IT group to process, store, and merge with the train database.

In case of an "Alert" message, it is then communicated to MNR's Operations Control Center (OCC) for follow-up action, including inspection, repair and maintenance activities that are managed by MNR's Mechanical department. [Figure 4-12](#) provides an overview of the interdepartmental communications that are carried out at MNR during day-to-day operations of the WILD system [1].



**Figure 4-12. Interdepartmental data flow for MNR's WILD system [1]**

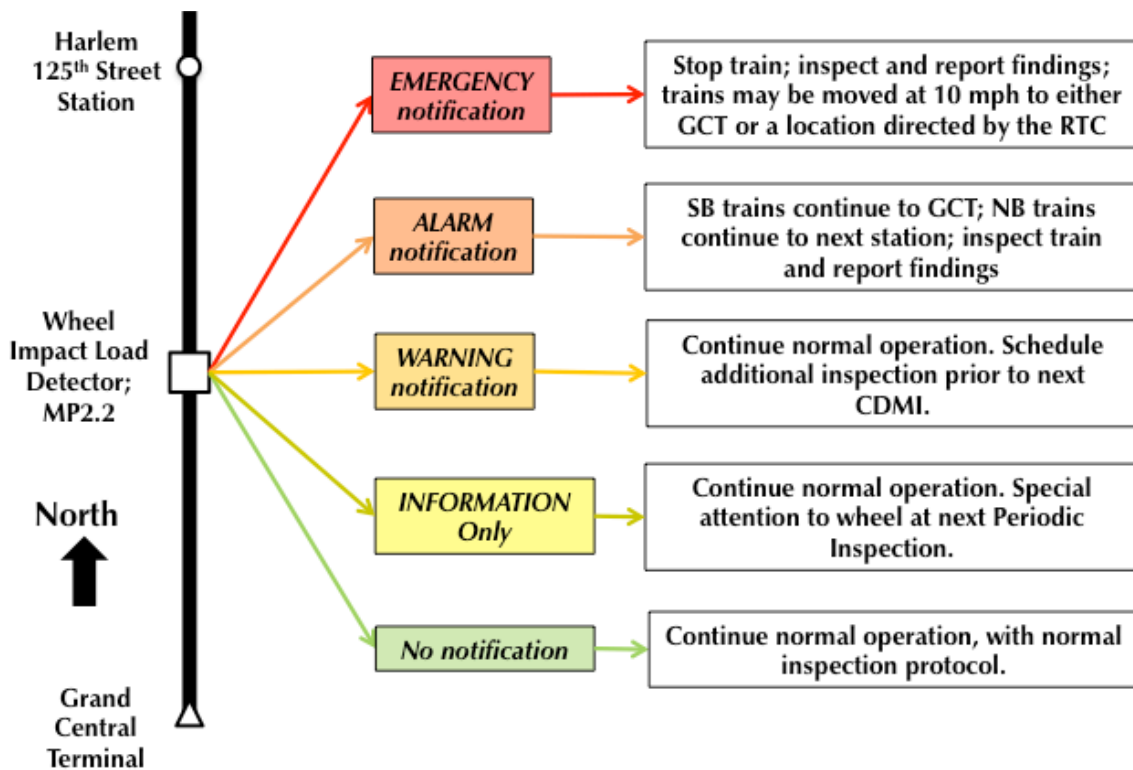
At MNR's OCC department, the RTC monitors all trains operating along the MNR network including foreign trains (Amtrak and freight trains). The monitoring by RTC crews includes solving various issues that trains may encounter en-route including the notifications that they receive from wayside detectors such as WILD systems [1].

When an actionable alert is generated by a WILD system, several communication events may occur as follows [1]:

1. Automatic email messages are sent to various departments, including Operations and Mechanical
2. The alerts are broadcast on an MNR internal web page, (see [Appendix B](#)) for view by a larger audience
3. The alerts are broadcast to a dedicated screen at the OCC
4. An IMS/AMS shop order is created to track the incident and the required activity

It should be mentioned that any wheel irregularities identified by MNR's WILD system is typically reported within 2 hours after detection, based on different levels of WILD thresholds [68].

The follow-up actions are assigned depending on the severity of the alert. [Figure 4-13](#) depicts MNR's actions following a WILD alert generated for a train passing by the detectors. Also, the action and information sequence following generating WILD alert is shown in [Figure 4-14](#) [1].



**Figure 4-13. Follow-up actions for a WILD alert at MNR [1]**

As shown in [Figure 4-13](#) and [Figure 4-14](#), the action assignment following a WILD alert can be summarized as follows [1]:

- In case of an “Emergency” alert (Dynamic Ratio  $\geq 5.0$ ), an e-mail is sent to OPS, FMO and MofE, to schedule a wheelset replacement by Qualified Maintenance Personnel (QMP) at the next available site
- In case of an “Alarm” alert ( $5 > \text{Dynamic Ratio} \geq 4.0$ ), an e-mail is sent to OPS, FMO and MofE, to schedule a wheelset inspection by QMP at the next available site
- In case of a “Warning” alert ( $4 > \text{Dynamic Ratio} \geq 3.0$ ), an e-mail is sent to FMO and MofE to schedule an inspection before Calendar Day Mechanical Inspection (CDMI)
- In case of an “Information” alert ( $3 > \text{Dynamic Ratio} \geq 2.0$ ), the QMP should inspect the flagged wheelset at the next scheduled CDMI with special attention

These actions are defined by MNR’s Mechanical Department through MMA#292 forms as shown in [Appendix C](#)

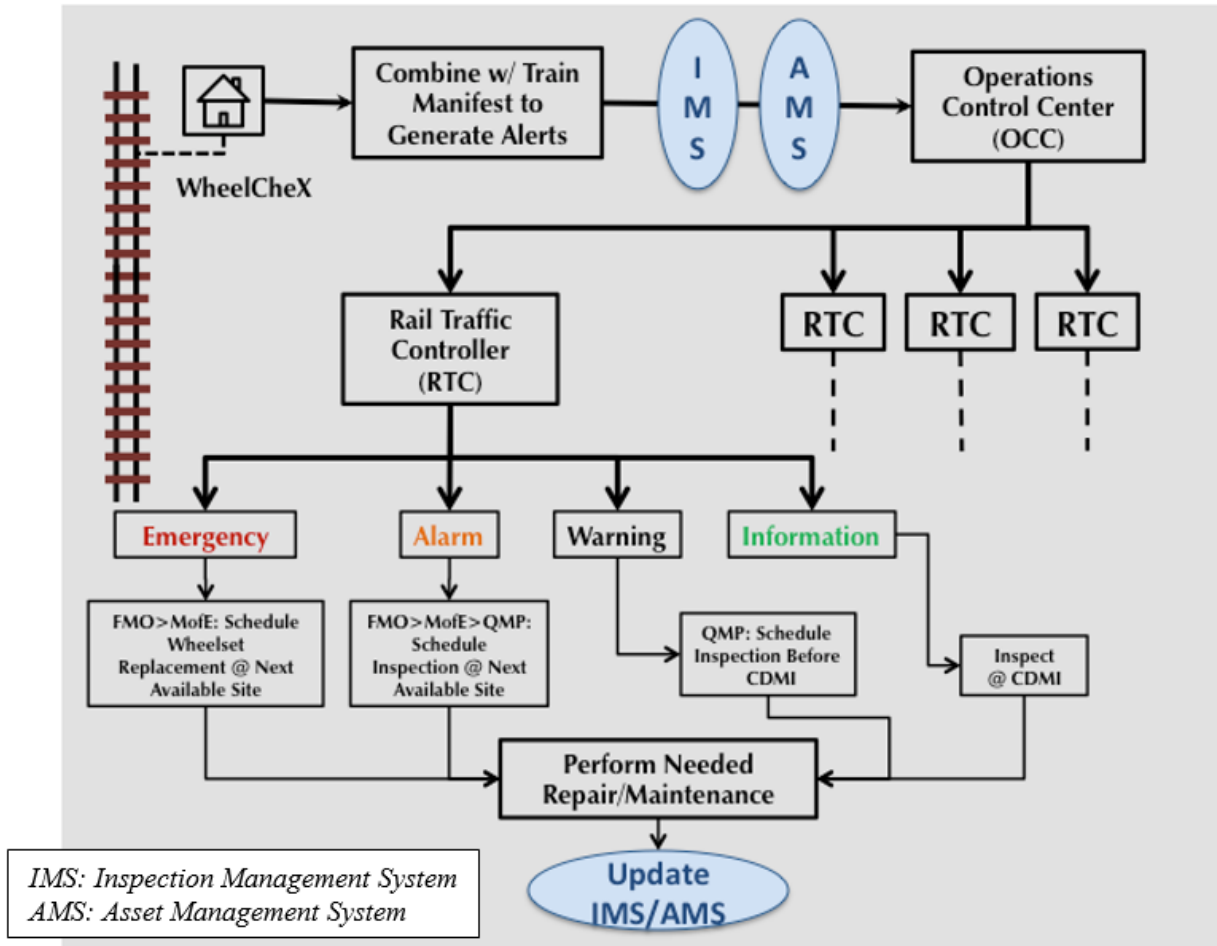


Figure 4-14. Information/action sequence of WILD system at MNR [1]

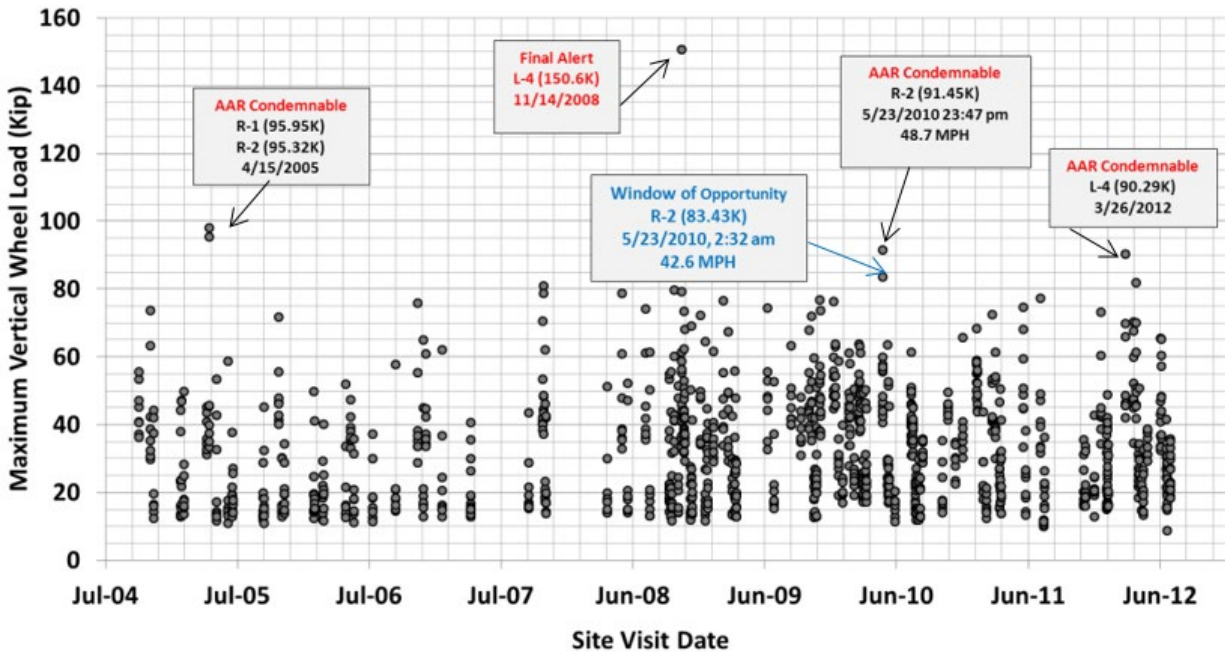
## 4.5.2 Monitoring WILD Assigned Actions

### 4.5.2.1 Freight Railroad Experiences

Several analyses were conducted on WILD data collected on freight trains to monitor the WILD alerts and assigned actions. One example of such practice would be monitoring the time history of maximum wheel loads captured by all WILD systems that a given rail vehicle passed over. As shown in Figure 4-15, the captured loads correspond to all eight wheels on a given freight car including both loaded and empty car conditions. The wheel loads that result in removal due to “AAR Condemnable” or “Final Alert” conditions are shown in Figure 4-15 for loaded car conditions [7].

As depicted in Figure 4-15, the queried car had wheels removed three times due to exceeding AAR Condemnable criteria and once due to a Final Alert. The first wheel removal event was triggered by the AAR Condemnable limit on wheels R1 and R2 (right wheels on B-end axles) on April 15, 2005. These wheels ran with no high impact loads until April 2010 when a high impact load exceeding AAR Condemnable level was identified on wheel R2. The car was also flagged on November 11, 2008, when a Final Alert level was exceeded on wheel L4 with no high impact

load history. The same wheel was detected 3.5 years later on March 26, 2012, where it was identified for a vertical load exceeding the AAR Condemnable limit of 90 kips [7].



**Figure 4-15. An example of maximum loads time history of a 100-ton 4-axle car wheels—empty and loaded conditions during 2004–2012 [7]**

Note that, as shown in Figure 4-15, wheel R2 had been initially flagged on the same day (May 23, 2010) approximately 21 hours before the removal action occurred due to exceeding the AAR Condemnable criteria (greater than 90-kips level). Further investigation revealed that the only difference between these two events within such a short time frame was that the train speeds recorded by the WILD system were different. The first wheel detection event was while WILD data was collected with the train passing the WILD site at a speed of 42.6 mph. The same wheel passed the other WILD site at a speed of 48.7 mph at the next wheel detection event. Thus, the higher speed (even if it was only approximately 6 mph higher than at the previous WILD site) caused higher impact loads to be captured by the WILD detectors [7]. These observations confirm that alert triggers at a WILD site are speed-dependent, as previously discussed.

#### 4.5.2.2 MNR Experiences

MNR has an embedded model for monitoring WILD alerts through a web-based Graphic User Interface (GUI), which is integrated within their AMS. Under this system, once a train is selected, the WILD alerts associated with given train axles can be displayed to determine if there are any warnings generated on the selected train (Figure 4-16). The users of this system are also able to search the WILD history of a given car for 1 week periods for all trains the car was in. This ability allows the user to determine what wheel load levels the car was experiencing before reaching the respective WILD thresholds (Warning, Alarm or Emergency level) [1].





Figure 4-16. An example of AMS GUI details for a selected MNR train [1]

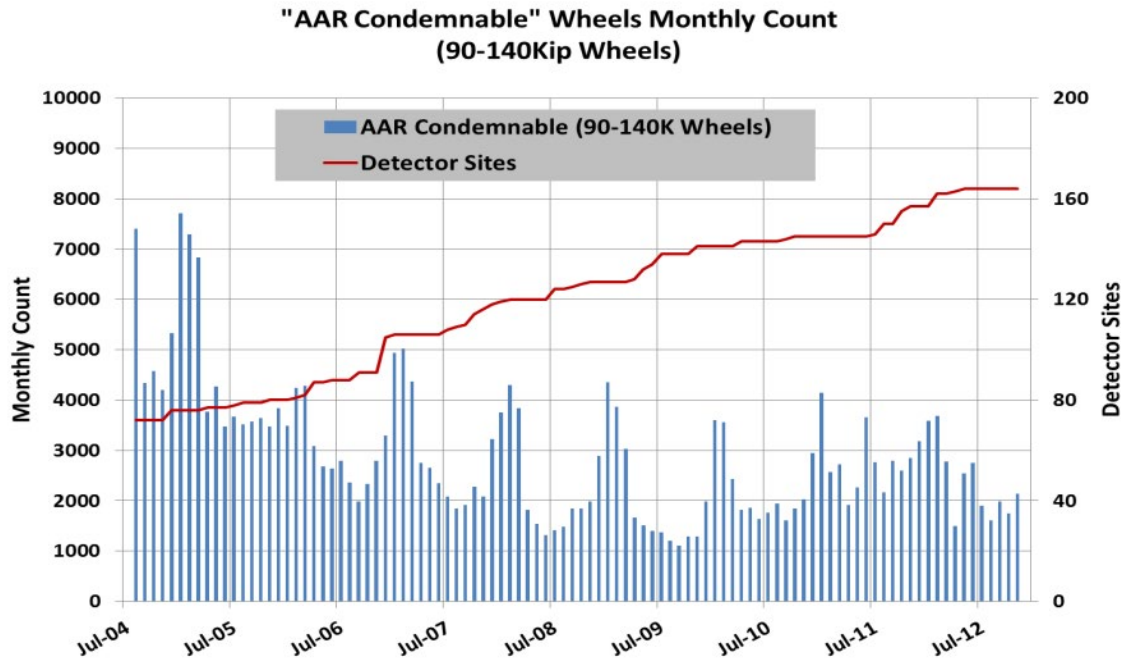
### 4.5.3 Best Practices on Monitoring Seasonal Patterns of WILD Data

#### 4.5.3.1 Freight Railroad Experiences

As part of a study conducted by SA on WILD records of freight trains during 2004–2012, there was an analysis of the seasonal pattern of WILD alerts. Figure 4-17 shows the seasonal pattern of WILD data extracted from the study. As depicted in Figure 4-17, a consistent pattern in the number of higher impact loads is present during the winter months. The impact loads are between 80–300 percent higher in the winter months than the rest of the year [7].

A research effort conducted by AAR’s Wheel Defect Prevention Research Consortium<sup>7</sup> program shows that higher impact loads during the winter months are caused because generally wheels tend to develop more shelling issues in the winter months, especially when trains are operating in snow conditions. The reason is that under snow conditions, snow can melt at the contact patch and infiltrate into cracks. When the defect point of wheel is moved away from the wheel-rail contact area, the melted snow within the wheel crack may freeze due to exposure to the ambient conditions, which can cause crack widening leading to a more rapid defect deterioration rate. Repeating such conditions over time can accelerate the crack growth and resulting in a shelling issue on the wheel tread [7].

<sup>7</sup> Steven L. Dedmon et al., “Accelerated Shelling –A Winter-Time Problem,” Wheel Shelling/Failure Study Group, June 2007, Topeka, KS.

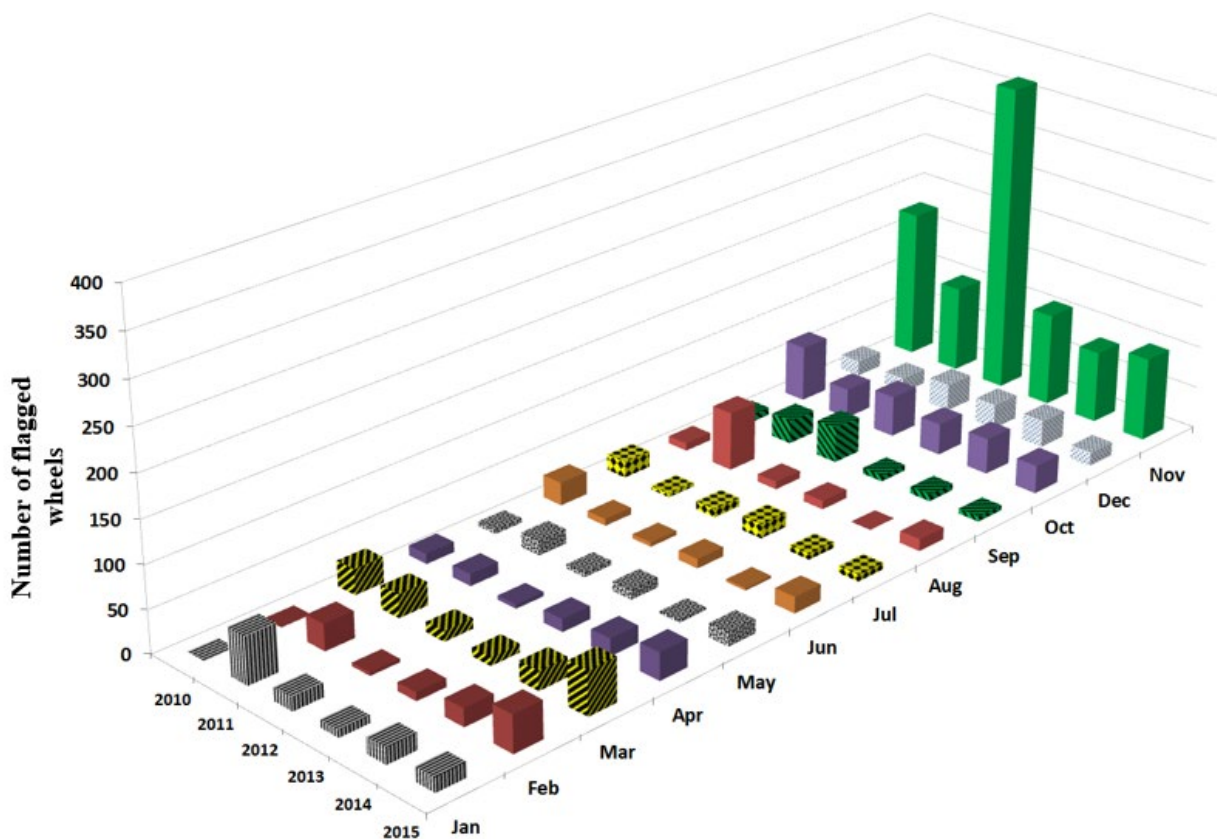


**Figure 4-17. “AAR Condemnable” wheels for the US WILD systems (monthly count) [7]**

Another study conducted in Australia also shows that wheel irregularities can not only cause more rapidly deteriorating wheel bearing failures, but that they are also more frequent during the winter months (May to September). Although all bearings were re-greased to reduce the failure rate during the winter months, installing a new WILD system demonstrated that all failed bearings had relatively higher wheel impact loads as well. Therefore, this result strongly suggests that re-greasing the bearings did not address issues related to the bearings, but the increased bearing failure rate in the colder months was mainly caused by wheel irregularities with a higher deterioration rate [77].

#### 4.5.3.2 MNR Experiences

Another example of a seasonal pattern reflected by WILD systems can be derived from MNR’s WILD data, showing similar behavior for commuter rail service. As shown in Figure 4-18, a seasonal trend of an increased number of flagged wheels can be observed during the fall season (particularly November) along MNR network. The reason behind flagging more wheels by MNR’s WILD system in the fall season is due to the fact that the majority of MNR tracks are surrounded by trees along the MNR’s right of way, which drop leaves onto the track. The wheel-rail friction coefficient is reduced when leaves are on the track. Thus, during the fall season there is always a higher risk of experiencing flat spots caused by applying wheel brakes on the fallen leaves on the rails. For instance, as shown in the figure, there are approximately 156.5 flagged wheels captured during November, on average, which compared to the average rate of capturing wheel irregularities during the rest of the year (19.5) is approximately eight times higher.



**Figure 4-18. Seasonal trend on number of flagged wheels by MNR’s WILD system during the fall season (particularly November) of 2010–2015**

*(Note: the order of Nov and Dec columns were switched in the figure, for the sake of better illustration)*

#### **4.5.4 WILD System Performance vs. Wheel Maintenance Actions**

As mentioned earlier, evaluating a WILD system by comparing the flagged wheels to wheel maintenance records can demonstrate the accuracy of the given WILD system in terms of minimizing false positive and false negative alerts. For instance, [Figure 4-19](#) compares the number of wheels flagged by WILD detectors for a selected car of MNR’s network versus the number of truing actions which have been applied on this car in the shops due to only “flat and shell spot” irregularities, during the 2010–2015 data collection period.

When comparing these two criteria, the detection/maintenance effectiveness ratio<sup>8</sup> was observed with values of 8.5%, 9.5%, 14.6%, 5.4%, 6.7%, and 7.0% respectively for 2010–2015. Since the “truing records” have been filtered for “only flat and shell spots,” which are typically detectable by WILD systems, a strong correlation between these two factors (flagged by WILD and trued in the shops) would be present. It is assumed that the WILD system is the only major technology/method for detecting the wheel irregularities (mainly flat and shell spots), and so this ratio can be used as a benchmark index to quickly evaluate the WILD system performance.

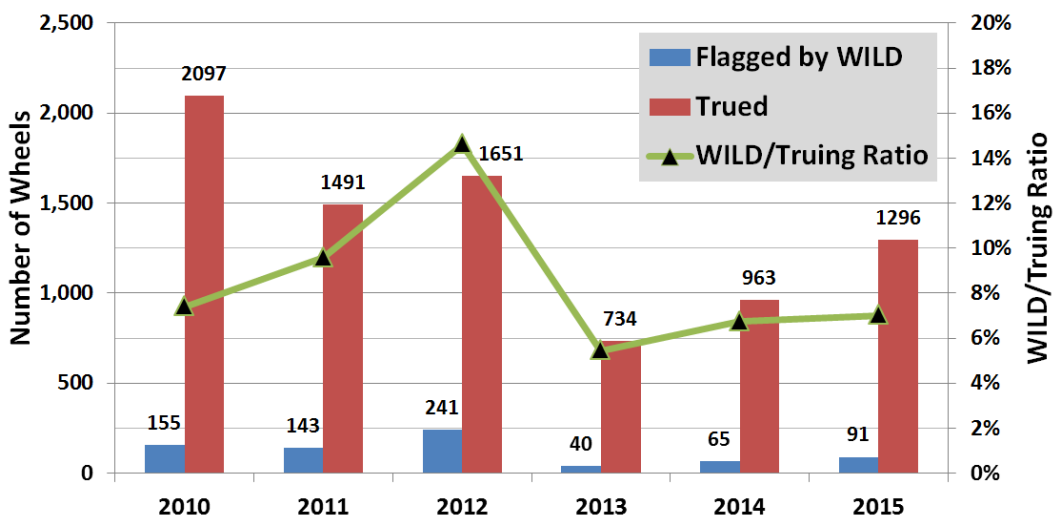
<sup>8</sup> Effectiveness Ratio = “# of flagged wheels by WILD” divided to “# of truing actions due to flat & shell spots”

However, there are other parameters that should be considered when comparing these two criteria:

- Some of the flat and shell spots could be captured and treated during preventive inspections before they can be flagged and detected by WILD systems.
- Whenever a wheel is determined to be trued due to any high impact causes, the other wheel on the same axle (and sometimes even other wheels on the same truck or on both trucks) should be also trued due to other regulations (maintaining a similar diameter for the two wheels on any one axle).
- There is always a chance that a wheel with a flat or shell spot may pass the WILD detector without passing the affected area over the strain gages or sensors (depending on the type of the WILD system, number of sensors or strain gages, distance between sensors on the WILD site, wheel size, and wheel passage speed). Therefore, the chance of wheel irregularity detection may vary on different WILD sites.

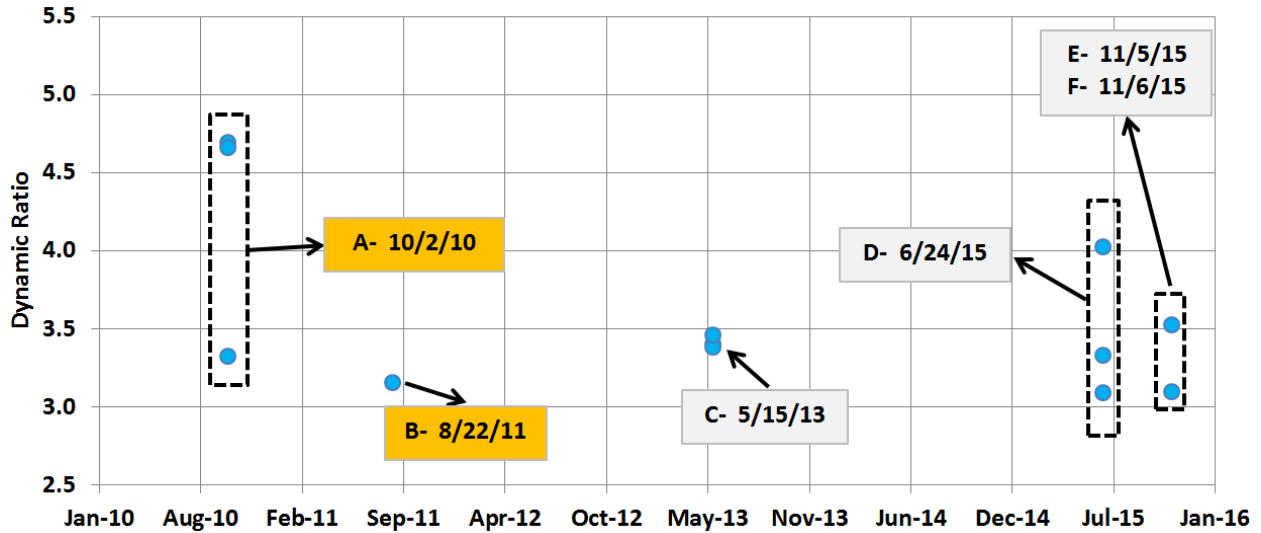
Thus, considering the above-mentioned criteria and assumptions, the respective “Effectiveness Ratio” of the WILD system can be bounded within thresholds of 1 to 50 percent. A WILD system with 50 percent effectiveness ratio can be interpreted as a system that captured all respective wheel irregularities that have been trued, while the mating wheel of the defective wheel was also trued to provide smooth dynamic behavior. Obviously, a high value of effectiveness ratio for a given WILD system (from 25 percent up to 50 percent) means it is a more effective system for capturing wheel irregularities in terms of flats, shell spots, and other issues which can cause high impact loads.

By evaluating the effectiveness ratio of the selected car series presented in Figure 4-19, we can observe that the given WILD system was more effective during 2012 with effectiveness ratio of 15 percent, in comparison to other years that the system effectiveness was under 10 percent thresholds.



**Figure 4-19. Comparison between number of flagged wheels by WILD and number of truing due to “flat and shell spot” irregularities, collected for the given car series of MNR during 2010–2015**

To compare the WILD effectiveness with the actual maintenance actions applied on a given car series, a particular car was randomly selected and tracked in terms of both WILD and maintenance records (either truing or change-out actions) during 2010–2015. Figure 4-20 depicts the histogram of all flagged wheels detected by WILD systems for the selected car, and Table 4-6 summarizes all maintenance actions (truing and change-out) applied on this car during the 2010–2015 data collection period.



**Figure 4-20. Histogram of flagged wheels by WILD system for a given car of MNR commuter RR during 2010-2015**

As shown in Figure 4-20, there are two WILD events (A and B highlighted in orange) that were triggered by the WILD system, but no maintenance action was recorded for the car in response to these WILD events (false positive) as shown in Table 4-6. As shown in Table 4-6, each maintenance action was classified as to whether it was triggered by the WILD system or was conducted through preventative maintenance/inspection (first column of the table). According to Table 4-6, four maintenance actions on the car were conducted due to WILD trigger system alerts within a few days after detection, while three truing actions were performed on this car due to inspection rather than being detected by the WILD system. Note that the irregularities that resulted in the change-out performed on October 11, 2013, could not be detected by the WILD system due to the nature of this wheel defect.



**Table 4-6. History of “Truing” and “Change-out” actions on the wheels of the same given car of MNR commuter railroad during 2010–2015**

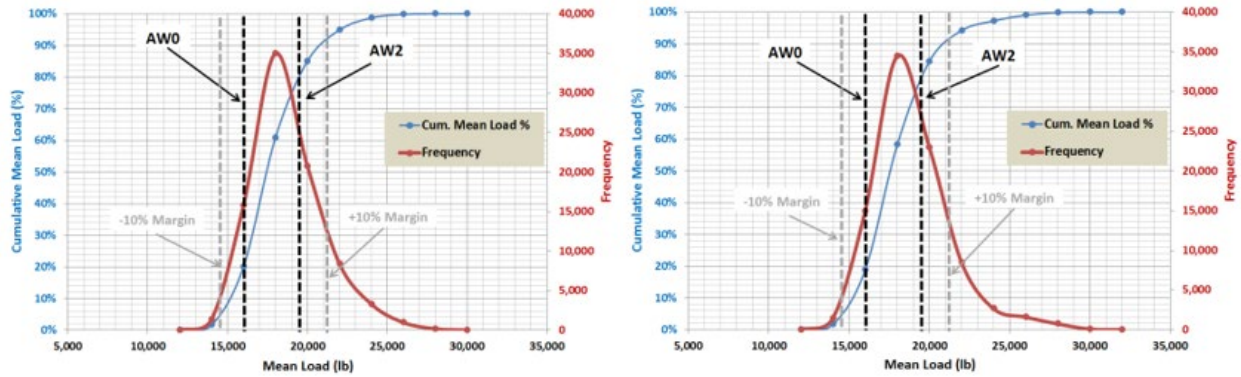
Due to “WILD” or “Inspection”	Date	Action	Cause	Axles
Inspection	8/24/2010	Truing	Flat Spots	All
WILD (A)	10/2/2010	No maintenance action was found		
WILD (B)	8/22/2011	No maintenance action was found		
Inspection	1/4/2013	Truing	Shell Spots	All
WILD (C)	5/21/2013	Change Out	Thin Rim	All
Inspection	10/11/2013	Change Out	Non Wheel Rep.	All
Inspection	4/30/2014	Truing	Shell Spots	All
WILD (D)	6/26/2015	Truing	Flat Spots	1, 2
WILD (D)	6/26/2015	Truing	High Flange	3, 4
WILD (E, F)	11/7/2015	Truing	Flat Spots	All

Overall, we can conclude that the WILD system had a fair correlation with the maintenance actions of the selected car as presented in [Table 4-6](#) (three truing actions detected by WILD out of six detectable truing records).

**4.5.5 Improving Calibration Procedure Using Collected WILD Data**

As explained earlier, the collected mean load of WILD data can be assessed through a long-term analytical approach, to verify the calibration procedure. For instance, the mean load distributions of two selected cars of the MNR fleet (same car series) are compared in [Figure 4-21](#), based on the data derived from MNR’s WILD records. As presented in [Figure 4-21](#), both cars have a very symmetric mean load distribution considering both frequency and cumulative mean load values. On the other hand, the mean load distribution of data collected by the WILD system should be mainly bounded within the upper and lower thresholds of the wheel loads corresponding to when the car is fully loaded or empty. It is particularly important that there should not be any mean load less than the lower threshold.

As shown in [Figure 4-21](#), the empty (AW0) and loaded (AW2) thresholds have been plotted on the diagrams for car #XXXX and #YYYY to visually compare how much of the measured mean loads are bounded within the upper and lower thresholds. The data shows that 17.5 percent (car #XXXX) and 17.7 percent (car #YYYY) are above the upper load thresholds. The expected error band on the WILD system measurements is 10 percent; thus, the measurements for these two cars fall outside the expected error band. The difference of 7.5 percent and 7.7 percent, respectively, is the actual error. Only 3.3 percent and 3.4 percent of the measured data are distributed out of the lower load thresholds, for car #XXXX and #YYYY, respectively.



**Figure 4-21. Mean load distribution of two selected cars (#XXXX on left and #YYYY on right) based on WILD data collected during 2010–2015**

Overall, we can conclude that 10.8 percent (car #XXXX) and 11.1 percent (car #YYYY) of the collected mean loads by WILD detectors were distributed beyond the acceptable levels of the cars when they are empty and fully loaded (with considering  $\pm 10\%$  margin error). Thus, it might be useful to review the calibration algorithm and parameters of WILD system. As a result, such modification on calibration procedure can provide a more reasonable mean load distribution against the upper and lower load thresholds.



## Appendix A. WPD Calibration Record Requirements

---

### WPD CALIBRATION RECORD REQUIREMENTS, MEASUREMENT-SPECIFIC TOLERANCES, AND RECORD OF DRIFT

<b>Operator</b>					
Company name:					
<b>Detector</b>					
Manufacturer:		Model:		Software version:	
<b>Site</b>					
Name:		Location:		MP:	
<b>Calibration</b>					
Reason for calibration:					
Method of calibration:					
Measurement	Tolerance	Drift			Reported Unit of Measure
		Pre-Cal	Post-Cal	Drift	
Flange height:	±0.01969 in.				inches
Flange thickness:	±0.01969 in.				inches
Flange angle:	1.5°				degrees
Rim thickness	±0.01969 in.				inches
Back-to-back:	±0.03937 in.				inches
Tread hollow	0.5 mm				millimeters
Date performed:				Valid through:	
Certified by:				Date certified:	

**Figure A-1. A draft of WPD calibration record requirements, issued by AAR [73]**

## Appendix B. MNR's Faults Page with WILD Alert

The screenshot shows a Windows Internet Explorer browser window displaying the MNR Faults page. The page header includes a train image, the time 6:29:52 AM, and a calendar for January 2010. The main content area is titled "Faults" and shows "Wheel Impact Faults for" with a search filter. A red alert box with the text "NEW WILD ALERTS DETECTED PLEASE CHECK" is overlaid on the page. Below the alert, a table displays fault data with columns for Train Name, Time, Direction, and Status.

Train Name	Time	Direction	Status
In		In	
In	4 086	38 32	Warn
In	4 086	45 32	Warn
In	4 086	52 32	Warn
In	4 086	38 32	Warn
In	4 086	40 32	Warn
In	4 086	46 32	Warn
Out	4 086	44 32	Warn
Out	4 086	45 32	Warn
Out	4 086	44 32	Warn
Out	4 086	42 32	Warn
In	4 086	20 32	Warn
In	4 086	45 32	Warn
Out	4 086	46 32	Warn

Figure B-1. GUI Based Interface for WILD Related Queries at MNR, Courtesy by MNR, 2015 [1]

# Appendix C

## MNR's Mechanical Maintenance Alert MMA # 292

Metro-North Railroad

**MECHANICAL MAINTENANCE ALERT**

---

MMA # 292	REISSUED: 05/06/2015	FLEET(S): All
-----------	----------------------	---------------

This MMA is to inform all MofE personnel regarding mandatory actions required by the notification levels of the Wheel Impact Load Detector (WILD).

MTA Metro North Railroad has a WILD system to sense defects (i.e. flat and shell spots) on rolling stock wheels. The system uses sensors applied to the rails to measure the stresses induced by a passing train wheel. The system provides an automatic e-mail message when the measured loads exceed pre-defined levels. The system also broadcasts the information to the M7 faults page for wide audience use and to a dedicated display in the Operations Control Center. The message is categorized into 4 levels to define the appropriate response for the conditions measured. An AMS shop order is automatically created to track the incident and the required repair activity.

E-Mail	LI	<u>Notification Level</u>	Peak Load (lbf)	Dynamic Ratio
Yes – Group 1	3	<b>Emergency</b>	140K and above	5.0 and above (9.99 max)
Yes – Group 1	2	<b>Alarm</b>	90K to 140K	4.0 to 4.99
Yes – Group 2	1	<b>Warning</b>	80K to 90K	3.0 to 3.99
No	0	<b>Information</b>	65K	2.0 to 2.99

**E-mail:** Group 1: OPS / FMO / MofE; Group 2: FMO / MofE

Each notification level has a defined action that must be followed. Wheels identified with defects will be trued or removed from service depending on the severity of the defect once qualified by QP /QMP.

**Emergency:** The FMO to notify MofE at the appropriate location for disposition and the Unit/Wheel will be removed from service.

**Alarm:** The FMO will inform MofE at the location of the train's next turn for wheel inspection by QMP

**Warning:** The wheel to be inspected by QMP prior to next CDML.

**Information:** The wheel to be addressed by QMP during next Periodic Inspection.

John Huzinec  
M of E Engineering

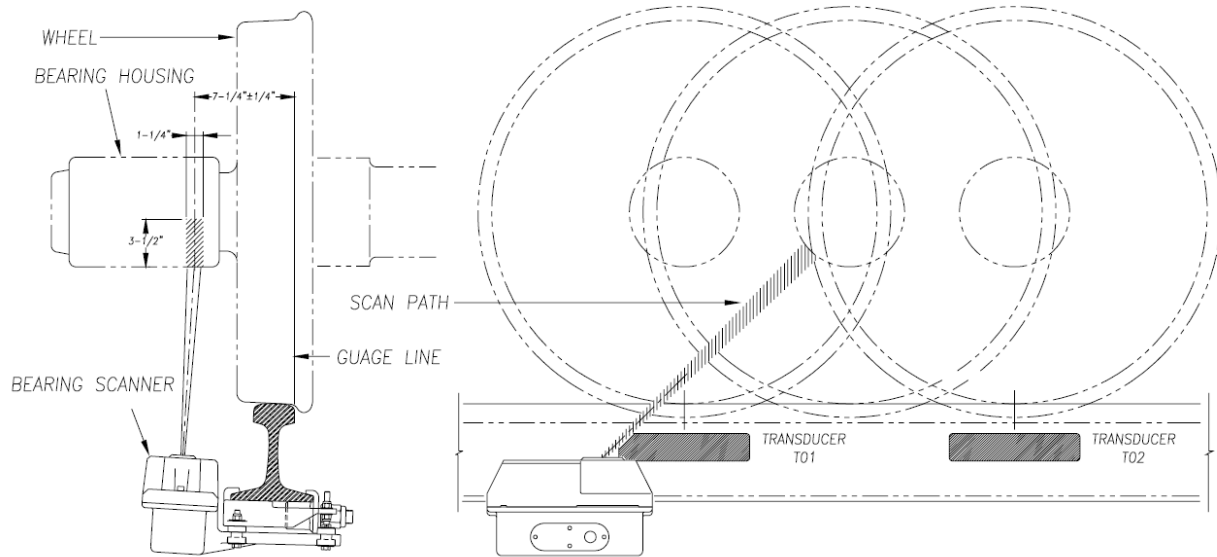
Rev. 2

**SAFETY IS PRIORITY ONE!**

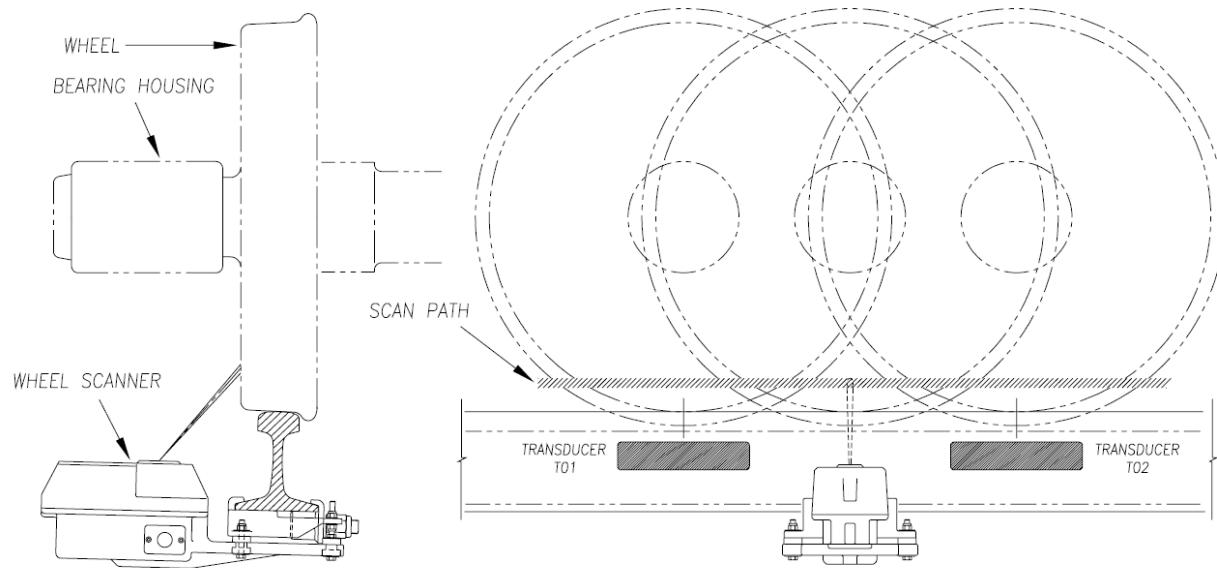
Figure C-1. MNR's mechanical maintenance alert (MMA) # 292, Courtesy by MNR, 2015 [1]

## Appendix D Cross-sections of HBD and HWD Systems

---



**Figure D-1. Location of HBD scanners about 7.25 inches from the gauge line [44]**



**Figure D-2. Location of HWD scanners to scan about 4 inches above the rail [44]**

## 5. References

---

### References

---

- [1] Sharma & Associates, "An Overview of Wayside Systems at Metro-North Railroad – Phase I (Draft)," FRA, Washington, DC, 2015.
- [2] K. V. Kumar, "Concept and Working of WILD," India, 2015.
- [3] Voestalpine, "Efficient Detection of Dragging Equipment," Voestalpine Signaling, Germany, 2014.
- [4] Ansaldo, "Weigh-In Motion (WIM) Wheel Impact Load Detector (WILD)," Ansaldo STS, Italy, 2015.
- [5] LBFoster, "[Rail Condition Monitoring by Salient Systems, Weigh-In Motion](#)," 2016. [Online].
- [6] LBFoster, "Hunting Truck Detector," LBFoster, USA, 2016.
- [7] Sharma & Associates, "Effectiveness of Wayside Detector Technologies on Train Operation Safety," FRA, Washington, DC, 2013.
- [8] S. Kalay and M. Witte, "Recent Advances in Automated Wagon Health Monitoring and Its Effects on Safety in North America," in *IHHA 2015 Conference*, Perth, Australia, 2015.
- [9] Mermec, "[MERMEC Monitoring Systems](#)," 2013. [Online].
- [10] Voestalpine, "Diagnostic and Monitoring Technologies," Voestalpine Signaling, Germany, 2015.
- [11] DeltaRail, "WheelChex Commissioning Procedure," DeltaRail, UK, 2009.
- [12] DeltaRail, "Data Verification and System Calibration Procedure," DeltaRail, UK, 2010.
- [13] AAR, "[Nationwide Wayside Detector System](#)," 2015. [Online].
- [14] TTC, "TADS, Trackside Acoustic Detection System," 2015. [Online].
- [15] H. Braren, "Wayside Detection - Component Interactions and Composite Rules," Rail Transportation Division Fall Conference (RTDF), Fort Worth, TX, 2009.
- [16] TTC, "Trackside Acoustic Detection System," AAR, Pueblo, CO, 2016.
- [17] AAR, "AAR Manual of Standards and Recommended Practices Sensors; Acoustic Roller Bearing Detector Level-1 Indications, Standard S-6000," AAR, Washington, DC, 2012.
- [18] T. Sultana, "Safety Impact of Wayside Detector Systems, Systems, Improved Automated Equipment Inspection," in *22nd Annual AAR Reserach Review*, Pueblo, CO, 2017.
- [19] Railadvisor, "[RailBAM® Bearing Acoustic Monitor](#)," 2014. [Online]
- [20] TrackIQ, "Wayside Monitoring Systems, Global product and software solutions for the rail industry," TrackIQ, Adelaide, Australia, 2014.
- [21] TrackIQ, "RailBAM® Bearing Acoustic Monitor," TrackIQ, Adelaide, Australia, 2014.
- [22] Siemens, "Siemens Rail Systems Helping the UK stay on the right track to success," Siemens, Germany, 2013.
- [23] C. Southern, A. D. Rennison and U. Kopke, "RailBAM® - An Advanced Bearing Acoustic Monitor: Initial Operational Performance Results," in *Conference On Railway Enginerring*, 2004.

## References

---

- [24] Wabtec, "[RailBAM - Bearing Acoustic Monitor](#)," Wabtec, 2017. [Online].
- [25] M. W. Anish Poudel, "Effectiveness of Automated Inspection Systems to Detect Vertical Split Rim and Shattered Rim Defects," in *22nd Annual AAR Research Review-TTC*, Pueblo, CO, 2017.
- [26] Nordco, "Wayside Cracked Wheel Detection System," Nordco Inc., Connecticut, USA, 2013.
- [27] FRA, "[Automated Cracked Wheel Detection](#)," 2017. [Online].
- [28] M. Witte, "Automated Cracked Wheel Detection," in *AAR Annual Review*, Pueblo, CO, 2013.
- [29] AAR, "AAR Manual of Standards and Recommended Practices Sensors; Detector Calibration and Validation Requirements, Standard S-6101," AAA, Washington, DC, 2015.
- [30] Progress-Rail, "Dragging Equipment and Derailment Detection," Progress-Rail Services, Alabama, USA, 2016.
- [31] STC, "iCube, Wayside Monitoring System, User's Guide," Southern Technologies Corporation (STC), USA, 2014.
- [32] Inspiredsystems.com.au, "[Dragging Equipment Detector](#)," Inspiredsystems, 2017. [Online].
- [33] J. Cline, "Improved Hot Box Detector Performance," in *19th Annual AAR Research Review*, Pueblo, CO, 2014.
- [34] S. Kalay, "AAR Strategic Research Implementation Safety and Efficiency," in *15th Annual AAR Research Review*, Pueblo, CO, 2010.
- [35] STC, "SmartScan, Catalog of Wayside Information Systems Products and Applications Software," Southern Technologies Corporation, USA, 2004.
- [36] E. Eisenbrand, "Hot box detection in European railway networks," *RTR Special*, pp. 2-11, 2011.
- [37] Voestalpine, "Phoenix MB Intelligent Rolling Stock Monitoring, Hot Box and Hot Wheel Detection with Multi Beam Technology," Voestalpine Signaling, Germany, 2014.
- [38] T. Sultana and S. Belpert, "Evaluation of Improved Hot Bearing Detectors," in *22nd Annual AAR Research Review*, Pueblo, CO, 2017.
- [39] T. Sultana and L. Stabler, "Condition-Based Maintenance with Detectors," in *IHHA*, Perth, Australia, 2015.
- [40] STC, "SmartScanNG Generic User's Guide," Southern Technologies Corporation (STC), USA, 2006.
- [41] AAR, "Inoperative Brake Indications as Determined by Wayside Detectors, Standard S-6031," Association of American Railroads (AAR), Washington, DC, 2016.
- [42] WID, "Truck Condition Monitoring," Wayside Inspection Devices (WID), Canada, 2016.
- [43] IHHA, Guidelines to Best Practices For Heavy Haul Railway Operations: Management of the Wheel and Rail Interface, Virginia Beach, VA: Simmons-Boardman Books, Inc., 2015.
- [44] P. Bladon, et al., "The Challenges of Integrating Novel Wayside Rolling Stock Monitoring Technologies, A Case Study," in *IHHA 2015 Conference*, Perth, Australia, 2015.

## References

---

- [45] G., Izbinsky, et al., "Monitoring Bogie Performance on Straight Track, Part 2. Tracking Error and Shift," in *IHHA*, Sweden, 2007.
- [46] Railinc, "Asset Health Data Summaries," Railinc, Cary, NC, 2015.
- [47] Railinc, "Equipment Health Management System (EHMS) User Guide," Railinc, North Carolina, 2015.
- [48] H. Tournay, "Use of Wayside Detection for Rolling Stock Performance Monitoring and Maintenance," in *IHHA*, Sweden, 2007.
- [49] Li R. Cheng, "Vehicle Hunting & Its Effect on North American Railroad Operations," in *IHHA*, Kiruna, Sweden, 2007.
- [50] Vortok, "Multi-Sensor, Multi-Parameter Sensor for Monitoring Stress in Railways," Vortok International, Devon, UK, 2017.
- [51] M., Richard, et al., "System to Detect Truck Hunting on Freight Railroads," TRB, Washington, DC, 2006.
- [52] T. W. Moynihan, et al., "Railway Safety Technologies," Research and Traffic Group, Canada, 2007.
- [53] LBFoster, "Truck Performance Detector (TPD)," LBFoster, Ohio, USA, 2005.
- [54] Semih Kalay, et al., "The Safety Impact of Wagon Health Monitoring in North America," in *WCRR*, India, 2011.
- [55] IEM, "Truck Performance Detector (TPD)," IEM Corp., USA, 2016.
- [56] Ansaldo, "Fibre Optic Detection of Weight and Load Imbalances on Moving Trains," Ansaldo STS, Italy, 2015.
- [57] Li R., Cheng, et al., "Effects of Improper Loading in Heavy Haul Operations," in *IHHA*, Sweden, 2007.
- [58] SchenckProcess, "[Schenck Process Rail weighing systems](#)," 2012. [Online]
- [59] LBFoster, "[Rail Monitoring by Salient Systems, WILD](#)," 2016. [Online]
- [60] International Engineering, "[WILD-Wheel Impact Load Detector & WILD+](#)," International Engineering, August 2016. [Online].
- [61] SchenckProcess, "[MULTIRAIL WheelScan](#)," 2013. [Online].
- [62] Track IQ, "Wheel Condition Monitor (WCM)," Track IQ, Australia, 2016.
- [63] Voestalpine, "ATLAS FO Precise Diagnosis of Wheel Defects and Vehicle Weights," Voestalpine Signaling, Germany, 2014.
- [64] DeltaRail, "Asset Management," UK, 2016.
- [65] J. Kesich and A. Golby, "MNR Wheel Impact Load Detection – Improved Performance at Reduced Cost," in *APTA conference*, Boston, 2011.
- [66] AAR, "Wheel Impact Load Detector Tests and Development of Wheel-Flat Specification, Report no. R-829," AAR, Chicago, IL, 1993.
- [67] LYNXRAIL, "Automated High-Speed Vehicle Inspection Systems," LYNXRAIL, Australia, 2011.
- [68] AEA, "Appendix 1, View, Automatic Vehicle Inspection Systems, A Product Profile by AEA Technology Rail," in *IHHA*, Kiruna, Sweden, 2007.



## References

---

- [69] M. Asplund and et al., "Automatic Laser Scanning of Wheel Profiles: Condition Monitoring to Achieve Greater Capacity for Existing Infrastructure in an Extreme Climate," in *IHHA*, New Delhi, India, 2013.
- [70] AAR, "AAR Manual of Standards and Recommended Practices, Wheel Profile Detector Standard S-6103," Association of American Railroads (AAR), Washington, DC, 2017.
- [71] FRA, "[Using Wheel Temperature Detector Technology to Monitor Railcar Brake System Effectiveness](#)," Technical Report No. DOT/FRA/ORD-13/50, Federal Railroad Administration, Washington, DC, 2013.
- [72] B. J. V. Dyk, M. S. Dersch, J. R. Edwards, J. Conrad, J. Ruppert and C. P. L. Barkan, "Evaluation of Dynamic and Impact Wheel Load Factors and their Application for Design," in *TRB 93rd Annual Meeting*, Washington, DC, 2014.
- [73] B. Stratman, Y. Li and S. Mahadevan, "Structural Health Monitoring of Railroad Wheels Using Wheel Impact," Vanderbilt University, Nashville, TN, 2006.
- [74] P. Harold, D. Harrison and J. M. Tuten. USA Patent 4,701,866, 1987.
- [75] A. A. S. Elsalebey, "Wheel Imbalance Effect on the Output of Wheel Impact Load Detector System (WILD), A Thesis," Colorado State University, Pueblo, CO, 2014.
- [76] M. L. Lee and W. K. Chiu, "A comparative study on impact force prediction on a railway track-like structure," *Structural Health Monitoring*, vol. 4, no. 4, pp. 355-376, 2005.
- [77] S. Lechowicz and C. Hunt, "Monitoring and Managing Wheel Condition and Loading," Teknis, Australia, 2000.
- [78] TSB, "Railway Investigation Report, R13T0060, Main-track train derailment," Transportation Safety Board of Canada, Ontario, 2015.
- [79] FRA, "[Federal Railroad Administration, Office of Safety Analysis](#)," 2011. [Online].
- [80] Nagory FOSTER, "Wheel Impact Load Detector," Nagory FOSTER, India, 2015.
- [81] A. Nurmikolu, P. Salmenpera, S. Mäkitupa and K. Lane, "Statistical Analysis of Wheel Impact Load Data and Review for Finnish Impact Load Limits," in *10th IHHA Conference*, India, 2013.
- [82] R. Wiley, "Railway Fleet Management: Using Acoustic Bearing Detector (ABD) Data," 2016.
- [83] ApnaTech, "Railway Products and Solutions," Apna Technologies & Solutions, India, 2017.
- [84] TTC, "AAR Strategic Research Implementation Safety and Efficiency," AAR, Washington, DC, 2010.
- [85] R. Donnelly and et al., "Application of an Acoustic Bearing Monitor in a Heavy-Haul Environment," in *IHHA*, Sweden, 2007.

## Acronyms and Abbreviations

---

Abbreviations & Acronyms	Definitions
ABD	Acoustic Bearing Detectors
X	A given parameter/variable
AW0	All Wheels Unloaded (empty transit car)
AW2	All Wheels Loaded (loaded transit car)
AMS	Asset Management System
AAR	Association of American Railroads
TPDG	A TPD Measurement of Horizontal Force
TPDL	A TPD Measurement of Lateral over Vertical Force
ACWD	Automatic Cracked Wheel Detector
AEI	Automatic Equipment Identification
BNSF	Burlington Northern Santa Fe Railway
CDMI	Calendar Day Mechanical Inspection
CN	Canadian National Railway
CP	Canadian Pacific Railway
CTC	Centralized Train Controller/Center
CCI	Certified Car Inspection
C&S	Communication and Signal
DED	Dragging Equipment Detector
EHMS	Equipment Health Management System
FDP	Fault Diagnostic Procedure
FRA	Federal Railroad Administration
FMO	Fleet Management Office
FactIS	Fully Automated Car Train Inspection System
GCT	Grand Central Terminal
GUI	Graphic User Interface
g	Gravity Force
GPRS	General Packet Radio Service
GPS	Global Position System
HBD	Hot Box Detector
HWD	Hot Wheel Detector
HI	Hunting Index
IF	Impact Factor
IMS	Inspection Management System
InteRRIS <sup>®</sup>	Integrated Railway Remote Information Service
K	Kelvin Degree
kip	Kilo-Pounds
kN	Kilo-Newton
L/V	Lateral Force/Vertical Force
LAHRLV	Lead Axle High Rail Lateral/Vertical
LIRR	Long Island Rail Road
MofE	Maintenance of Equipment
MMA	Mechanical Maintenance Alert

**Abbreviations &  
Acronyms****Definitions**

---

MHz	Megahertz
MNCW	Metro-North Commuter Railroad
MNR	Metro-North Railroad
MTA	Metropolitan Transportation Authority
MP	Milepost
mm	Millimeter
NR	National Rail (Australia)
NYA	New York & Atlantic Railway
NB	Northbound
NEC	Northeast Corridor
NA	Not Available, or Not Applicable
OCC	Operations Control Center
OPS	Operations Service
OEM	Original Equipment Manufacturer
QMP	Qualified Maintenance Personnel
lbs.	Pounds
RFID	Radio-Frequency Identification
RailBAM <sup>®</sup>	Railway Bearing Acoustic Monitor
RTC	Rail Traffic Controller
ROC	Receiver Operating Characteristics
RD&T	Research, Development & Technology
SMS	Short Message System
SB	Southbound
STD	Standard Deviation
TADS <sup>®</sup>	Trackside Acoustic Detection System
TTC	Transportation Technology Center
TBOGI	Truck Bogie Optical Geometry Inspection
THD	Truck Hunting Detector
TPD	Truck Performance Detector
UMLER <sup>®</sup>	Universal Machine Language Equipment Register
UP	Union Pacific Railroad
DOT	U.S. Department of Transportation
VSR	Vertical Split Rim
WIM	Weigh-In Motion Detector
WILD	Wheel Impact Load Detector
WPMS	Wheel Profile Measurement System
WTD	Wheel Temperature Detector
WIFI	Wireless Fidelity