

Global Exec Aviation  
Learjet 60  
Columbia, South Carolina  
September 19, 2009  
DCA08MA098

**National Transportation Safety Board  
Washington, DC**

**Survival Factors Group Chairman's Report**

**Attachment 1**

Passenger Briefing Card

4 pages

# BOMBARDIER LEARJET 60XR

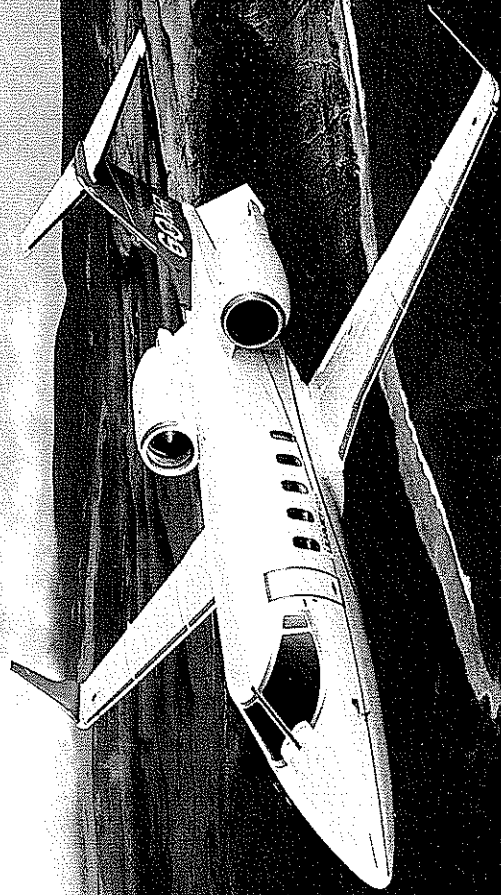

# SAFETY INFORMATION

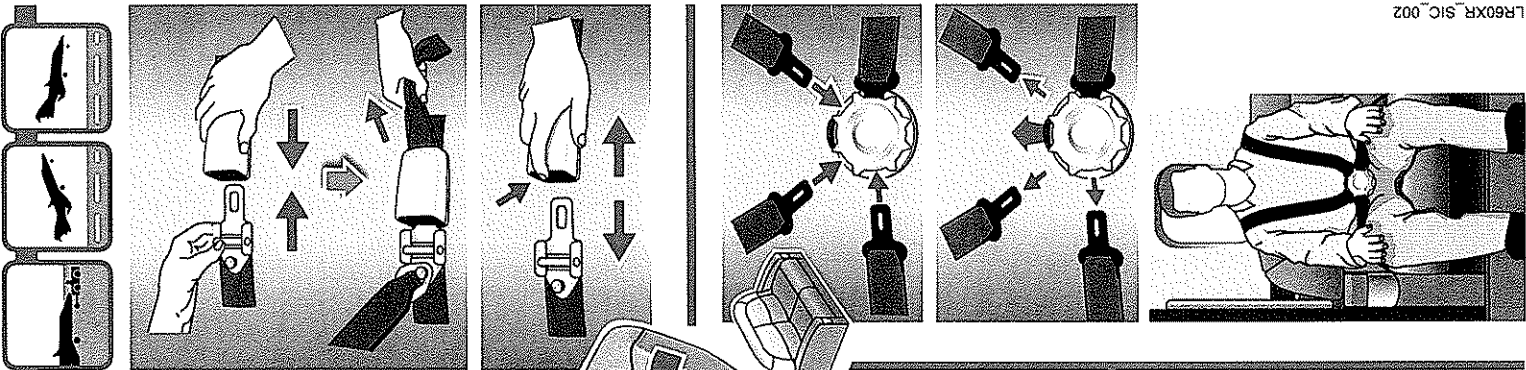

LR60XR\_SIC\_002

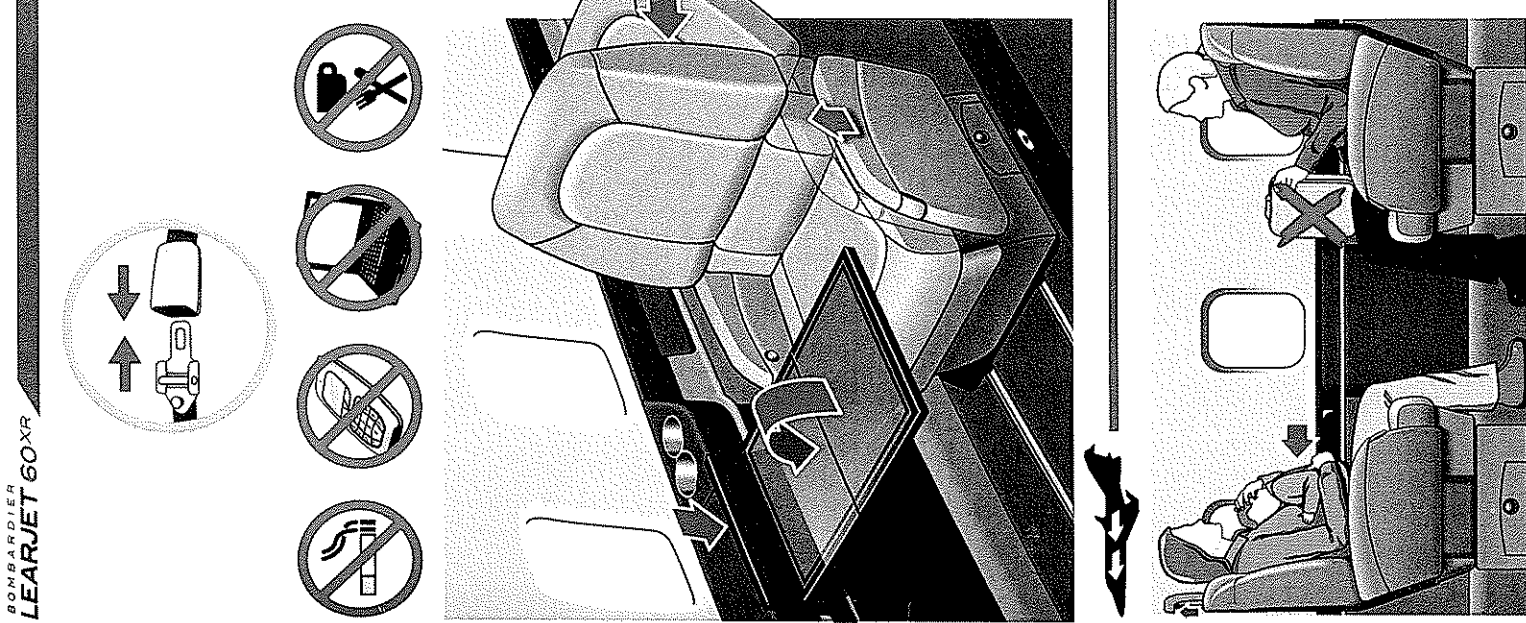

BOMBARDIER  
LEARJET 60XR

BOMBARDIER

© 2007 BOMBARDIER INC.

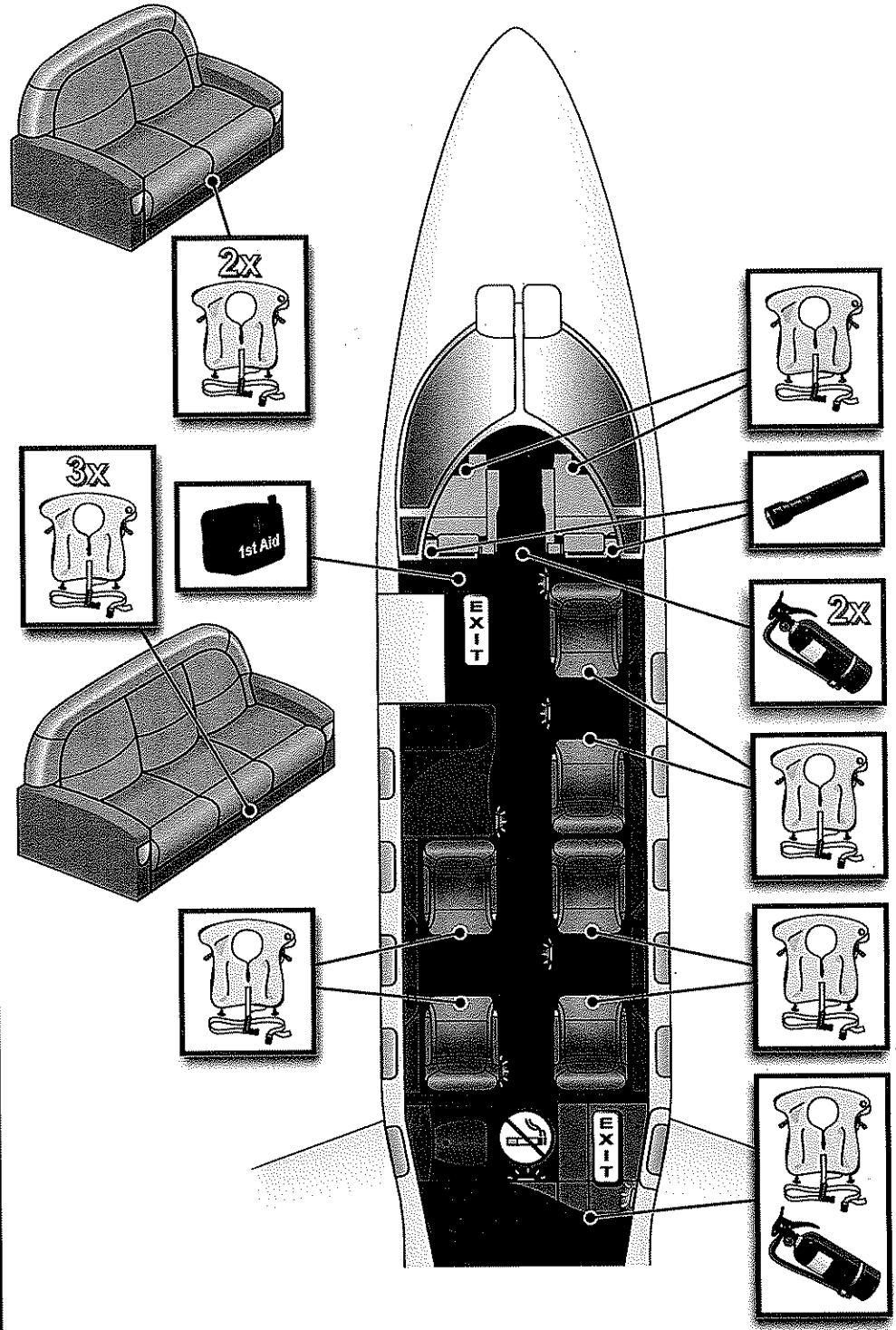

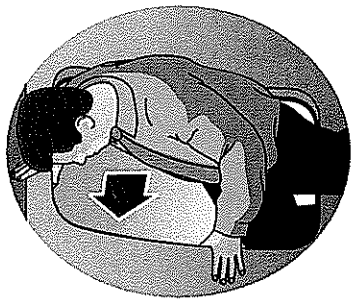
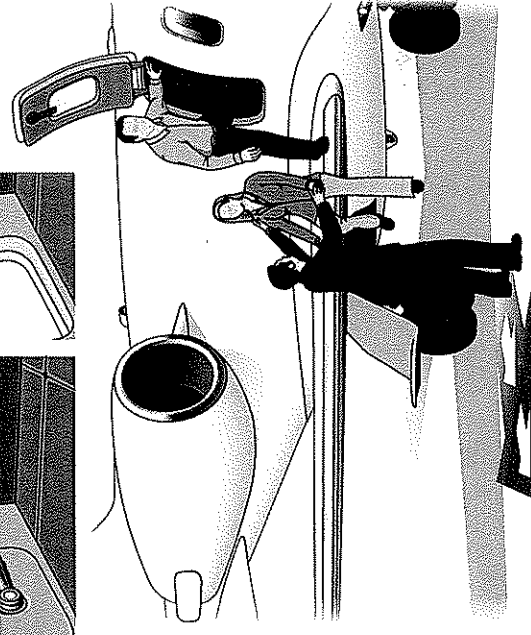
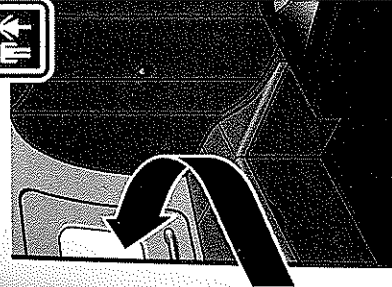
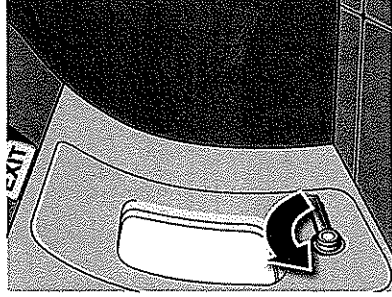
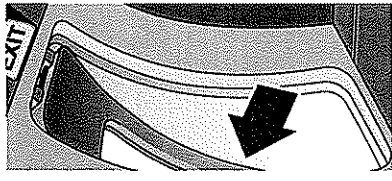
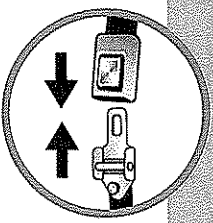
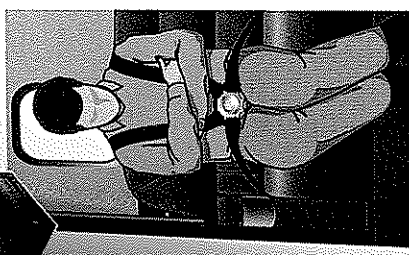
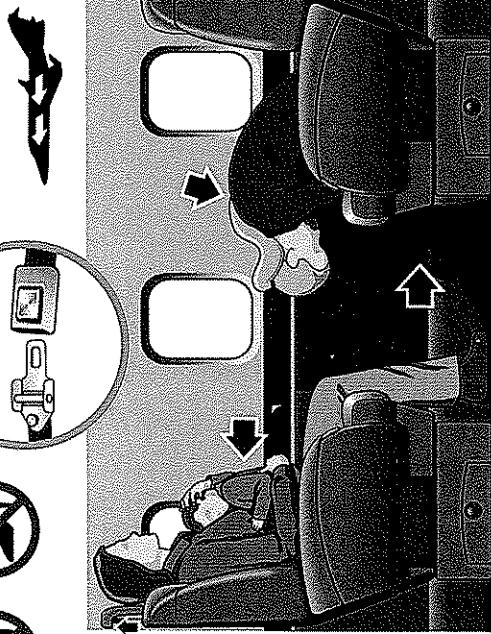
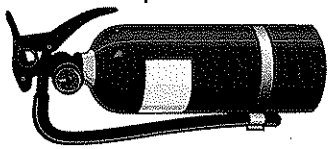
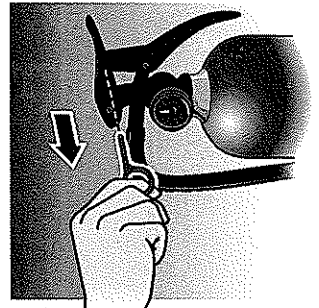
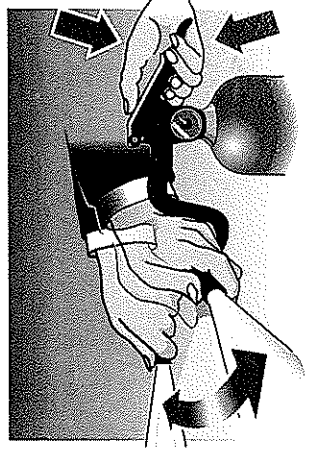
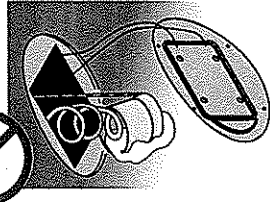
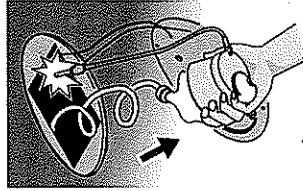
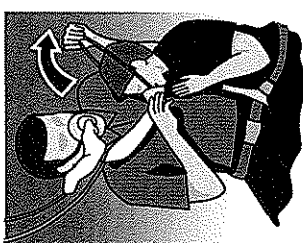
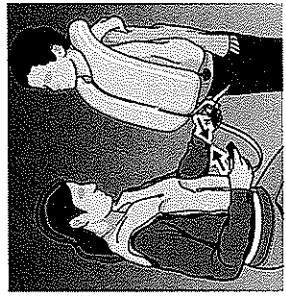
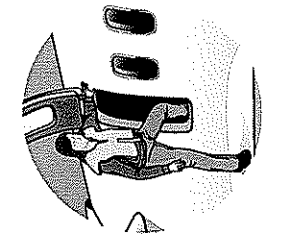
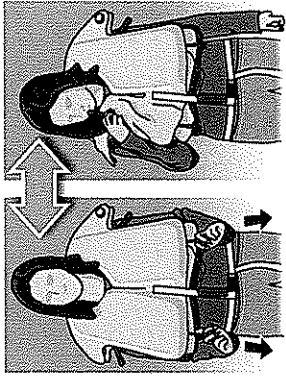
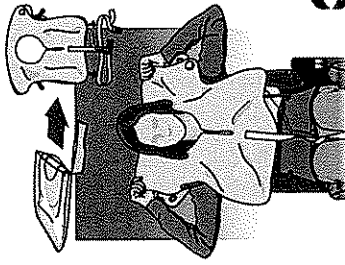
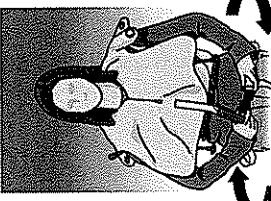
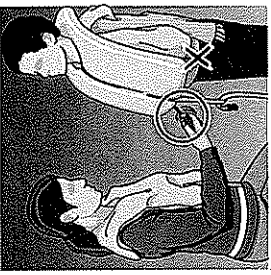
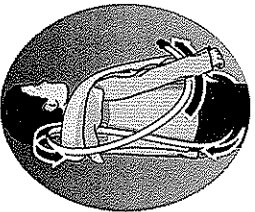

BOMBARDIER  
LEARJET 60XR

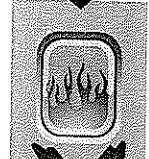
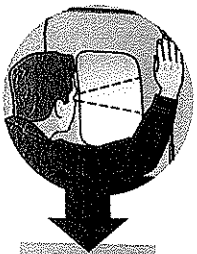

EXIT

