

Continental Airlines  
Boeing 737-500  
Denver International Airport  
Denver, Colorado  
December 20, 2008  
DCA09MA021

**National Transportation Safety Board**  
Washington, DC

**Survival Factors Group Chairman's Report**

**Attachment 4**

Passenger Information Card

6 pages

Continental  
Airlines



**B737-300/500**

(4/08)

### *For your safety*

Obey "Fasten Seatbelt" and "No Smoking" signs.  
Follow all instructions given by crew members.

### *Per la vostra sicurezza*

Rispettare i simboli segnaletici "Allacciare le cinture di sicurezza" e "Vietato fumare".  
Seguire tutte le istruzioni impartite dal personale di bordo.

### *Para su seguridad*

Obedezca las señales de "Abrochense los cinturones" y "Prohibido fumar".  
Siga todas las instrucciones dadas por miembros de la tripulación.

### *Für Ihre Sicherheit*

Beachten Sie die Beleuchtungen "Bitte Anschnallen" und "Bitte Nicht Rauchen".  
Halten Sie sich an alle Anweisungen des Bordpersonals.

### *Pour votre sécurité*

Obéissez les signes de "Attachez vos ceintures" et "Défense de fumer".  
Suivez toutes les instructions données par les membres de l'équipage.

### **あなたの安全のために**

ご自身の安全のため、「シートベルト着用」と「禁煙」のサインに従ってください。  
乗務員の指示にはすべて従ってくださるようお願いいたします。

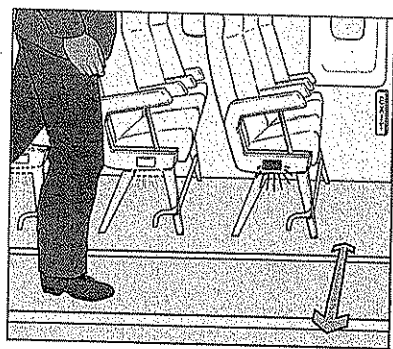
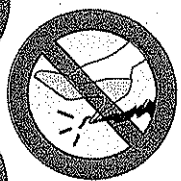
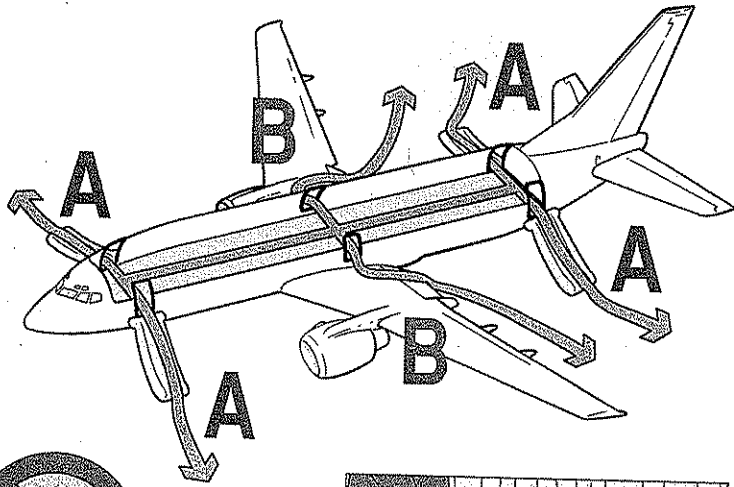
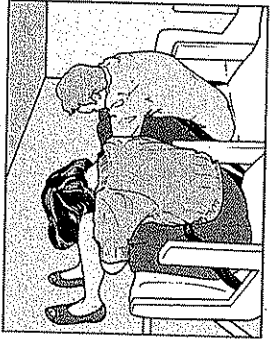
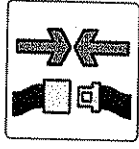
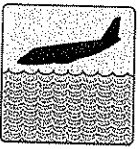
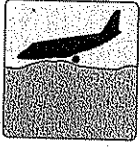
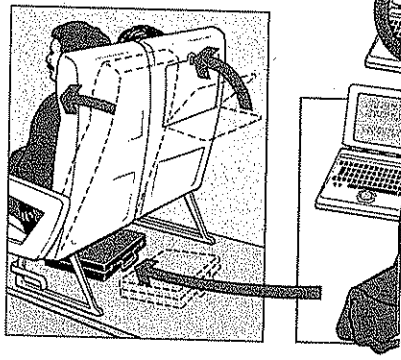

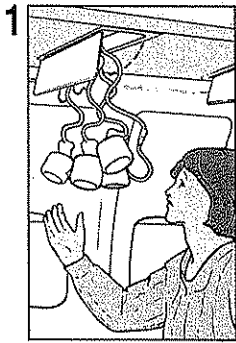
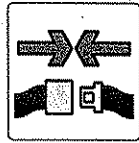
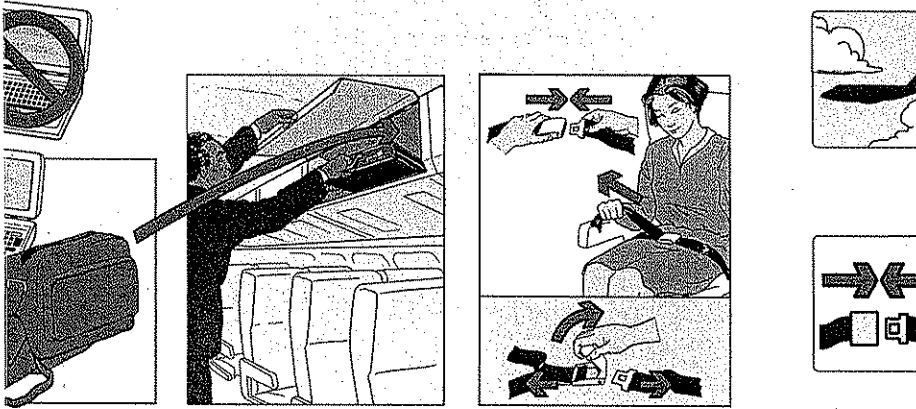

(Sec.) 0-00

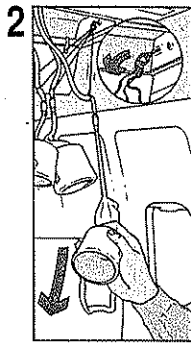

0-03



0-05

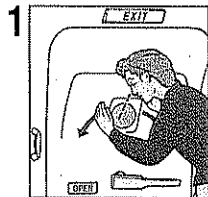

**A**

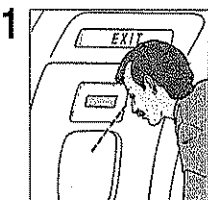
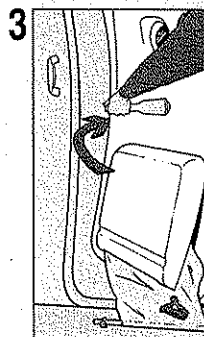
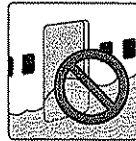

**B**

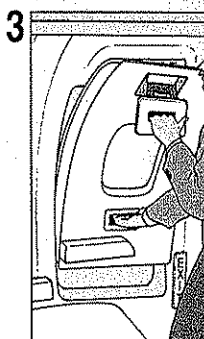
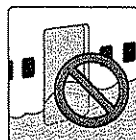

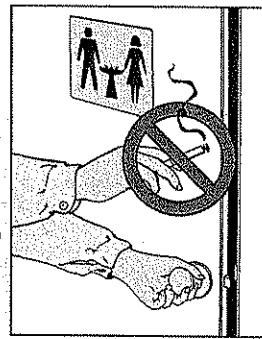

0:07

0:10

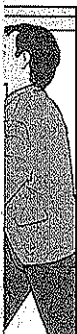
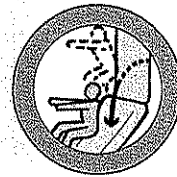
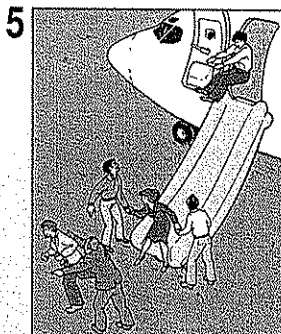
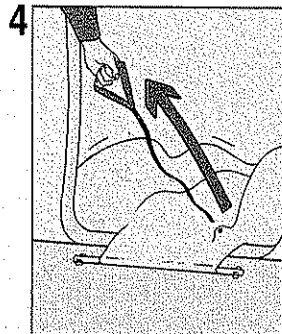
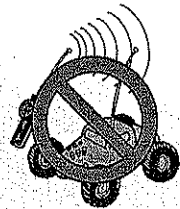

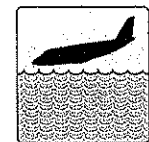
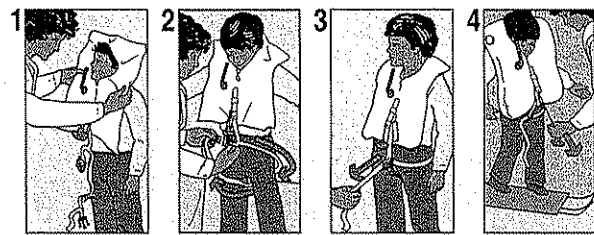
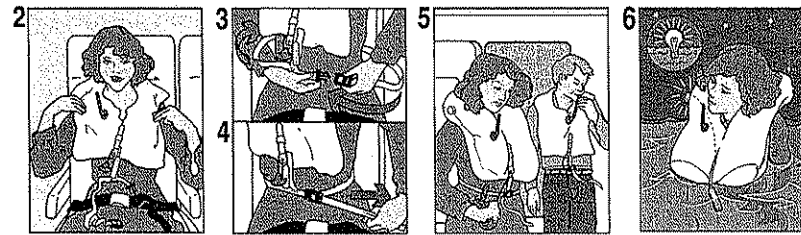
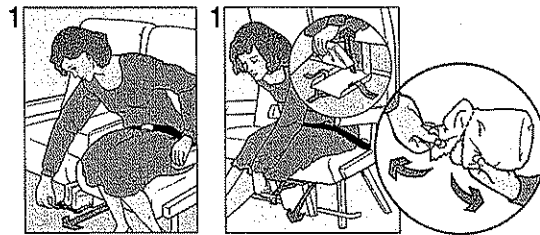
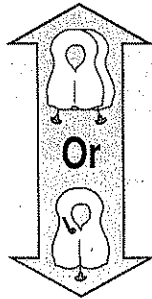
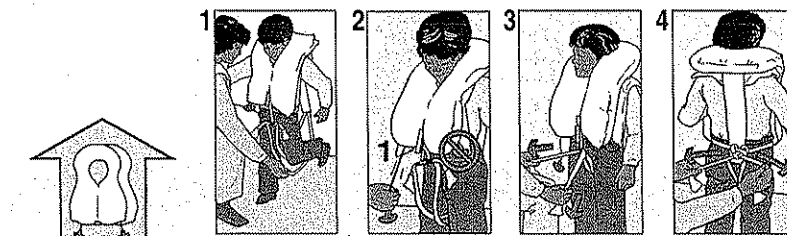
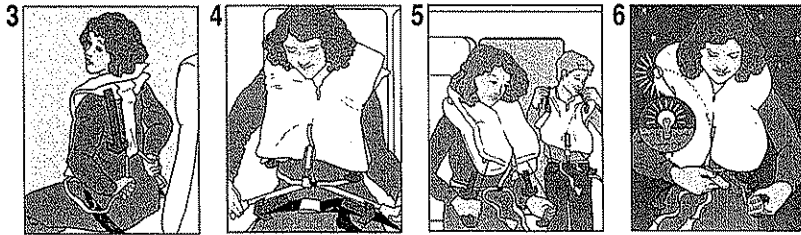
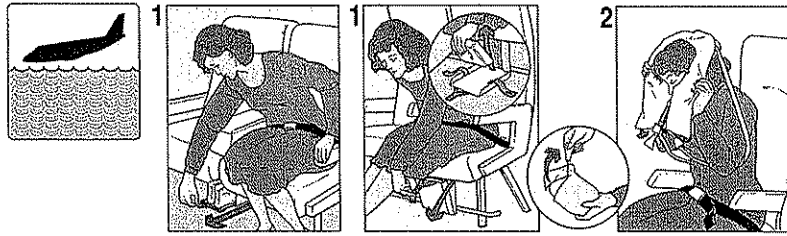

Aircraft without life vests will have flotation cushions:

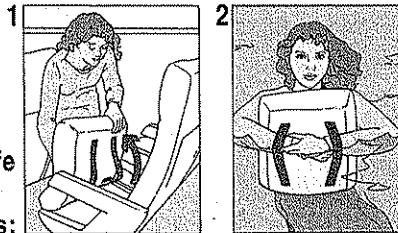

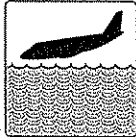

Aircraft for extended overwater operations will have life rafts:

