

NATIONAL TRANSPORTATION SAFETY BOARD

Office of Aviation Safety
Washington, D.C. 20594

Attachment 30 - UPS O2 Mask CBT Modules

**OPERATIONS/HUMAN PERFORMANCE SUPPORT TO
THE U.S. ACCREDITED REPRESENTATIVE**

DCA10RA092



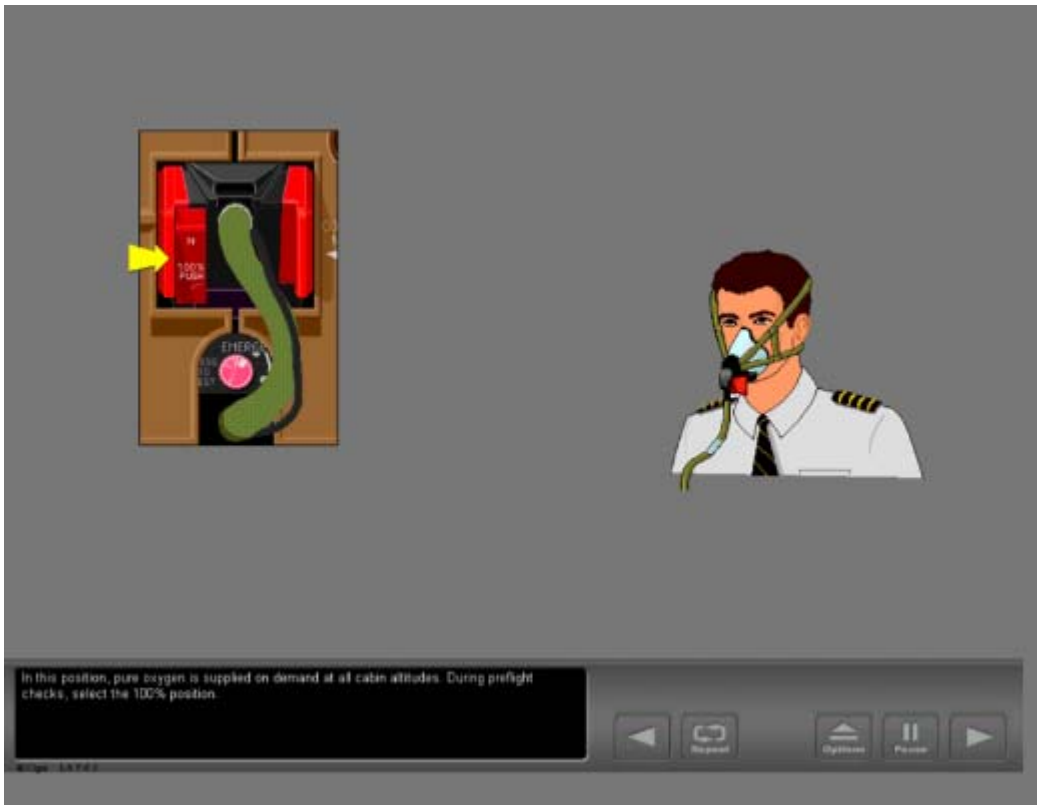



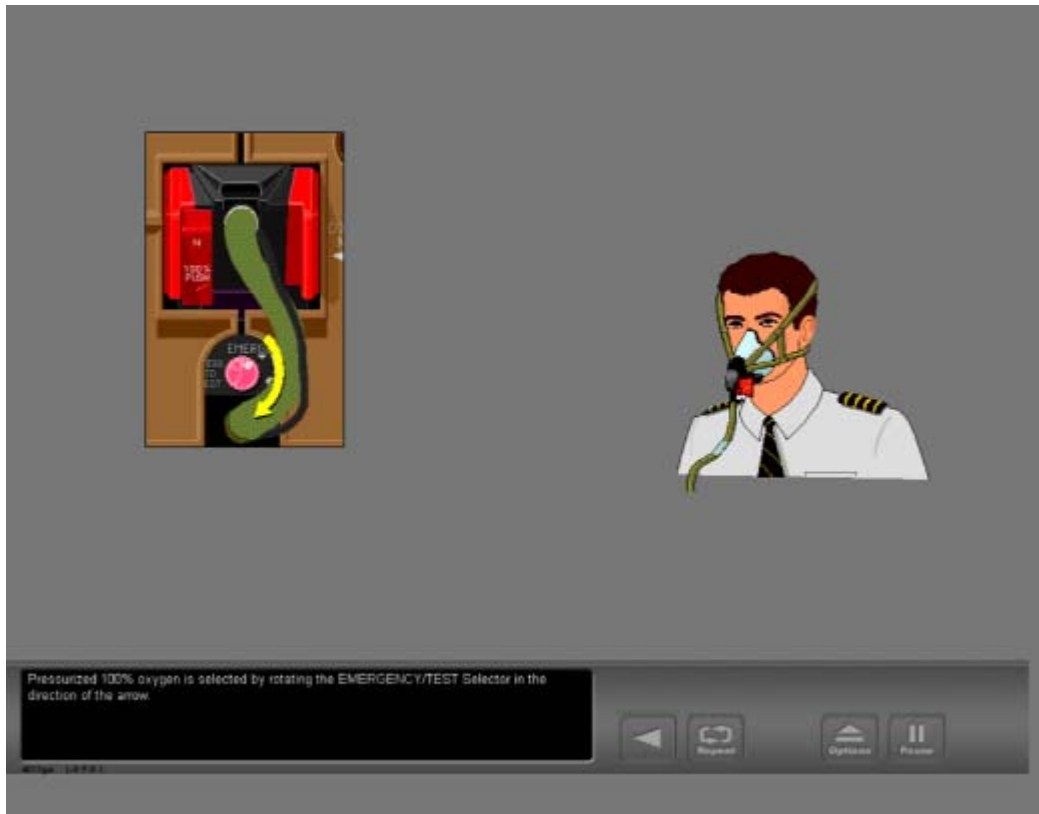

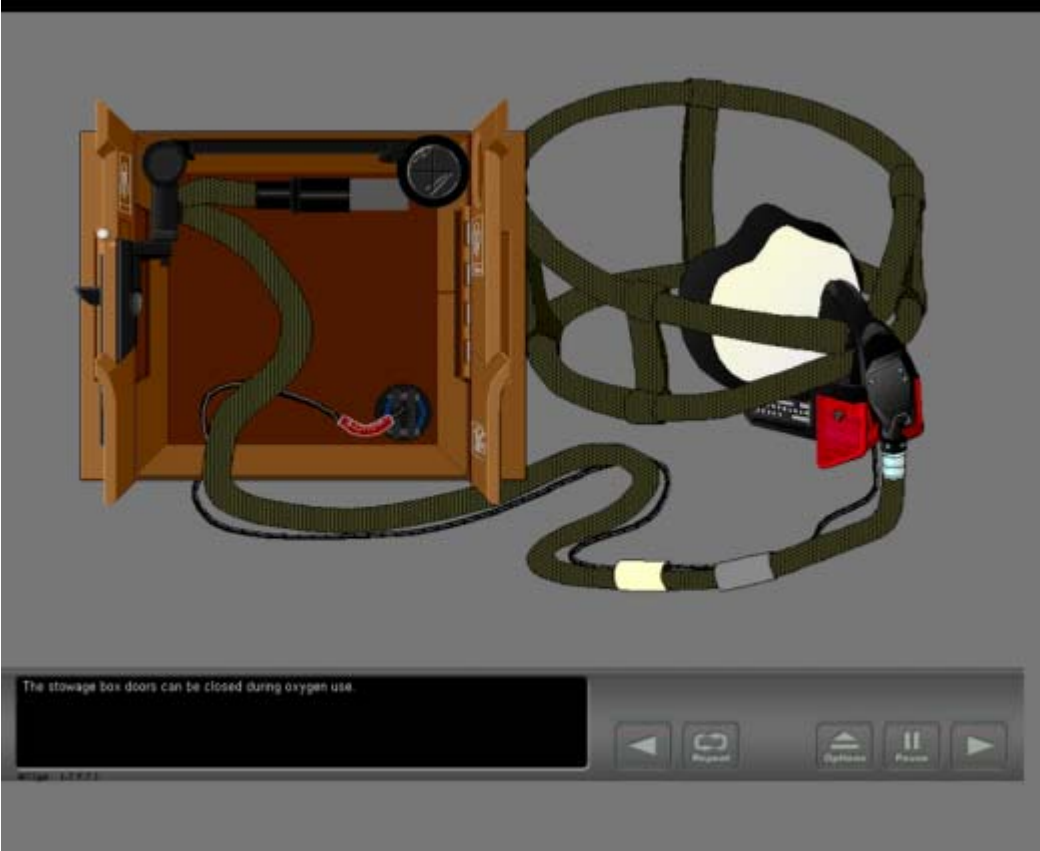

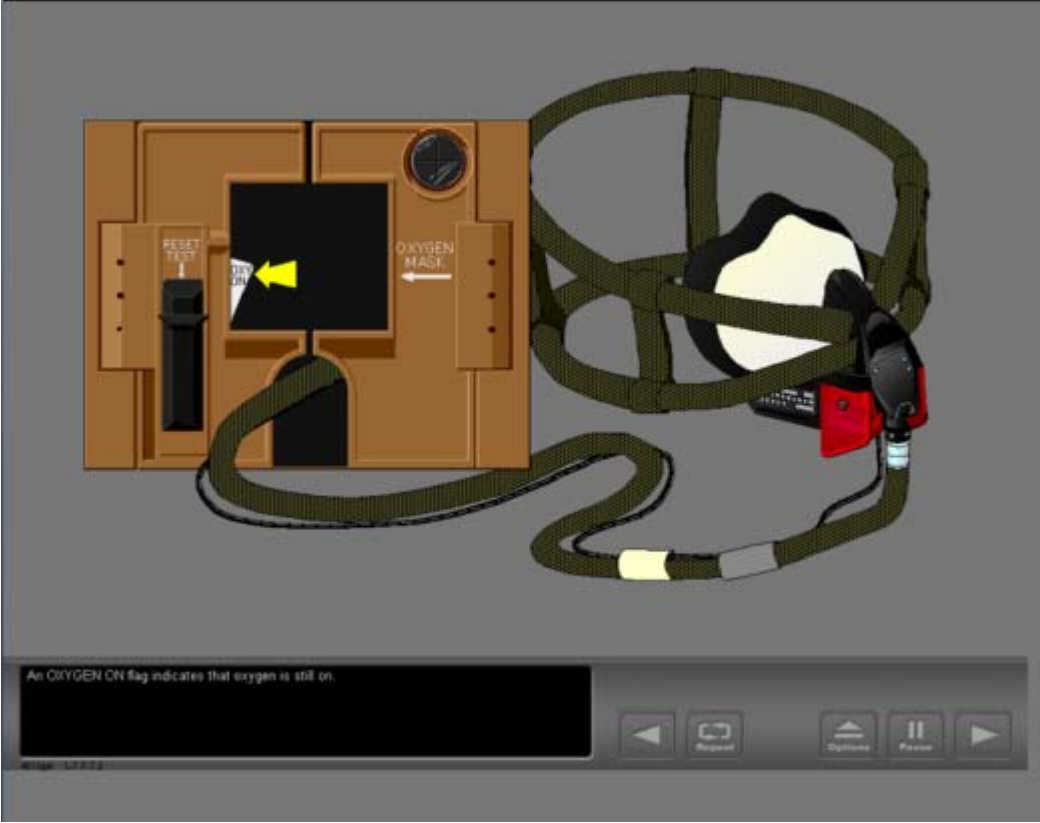

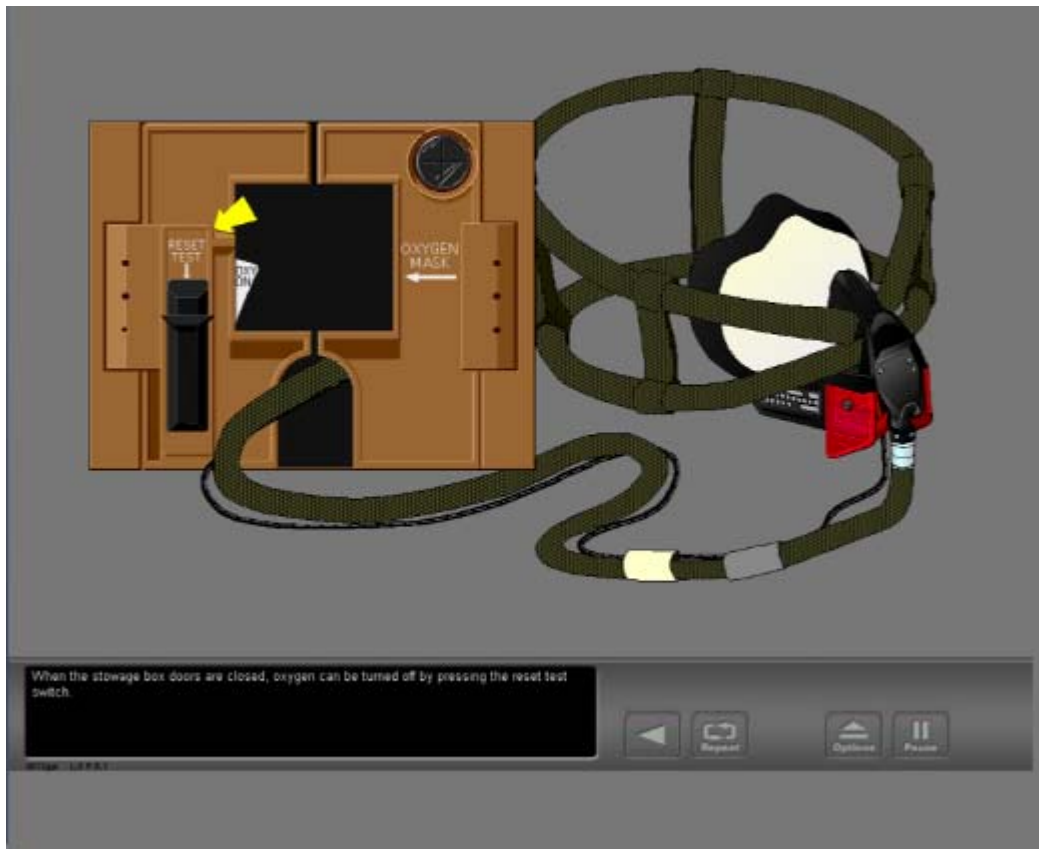
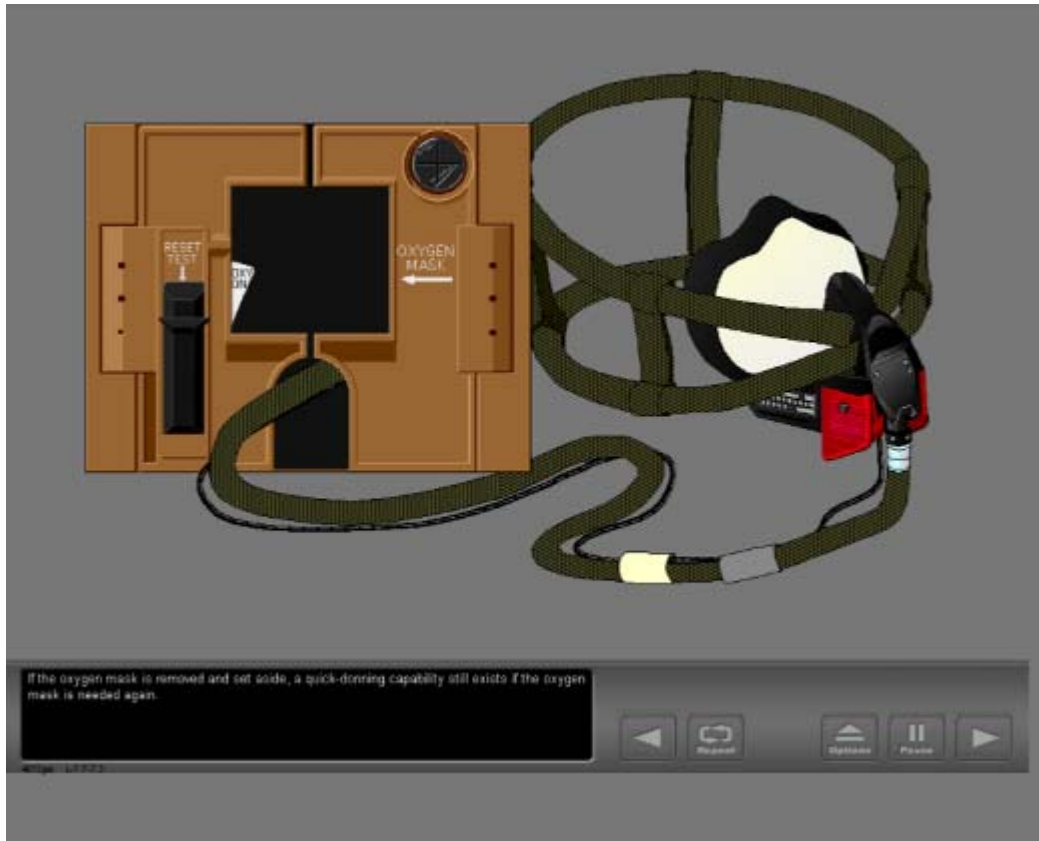

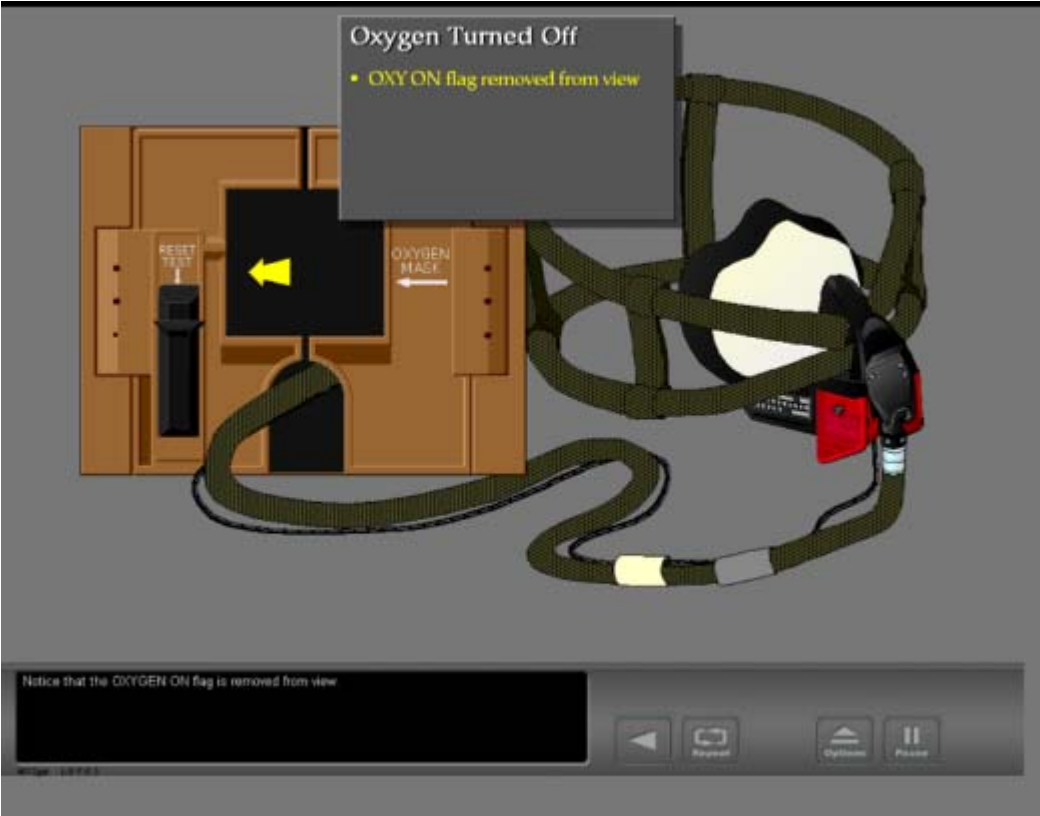

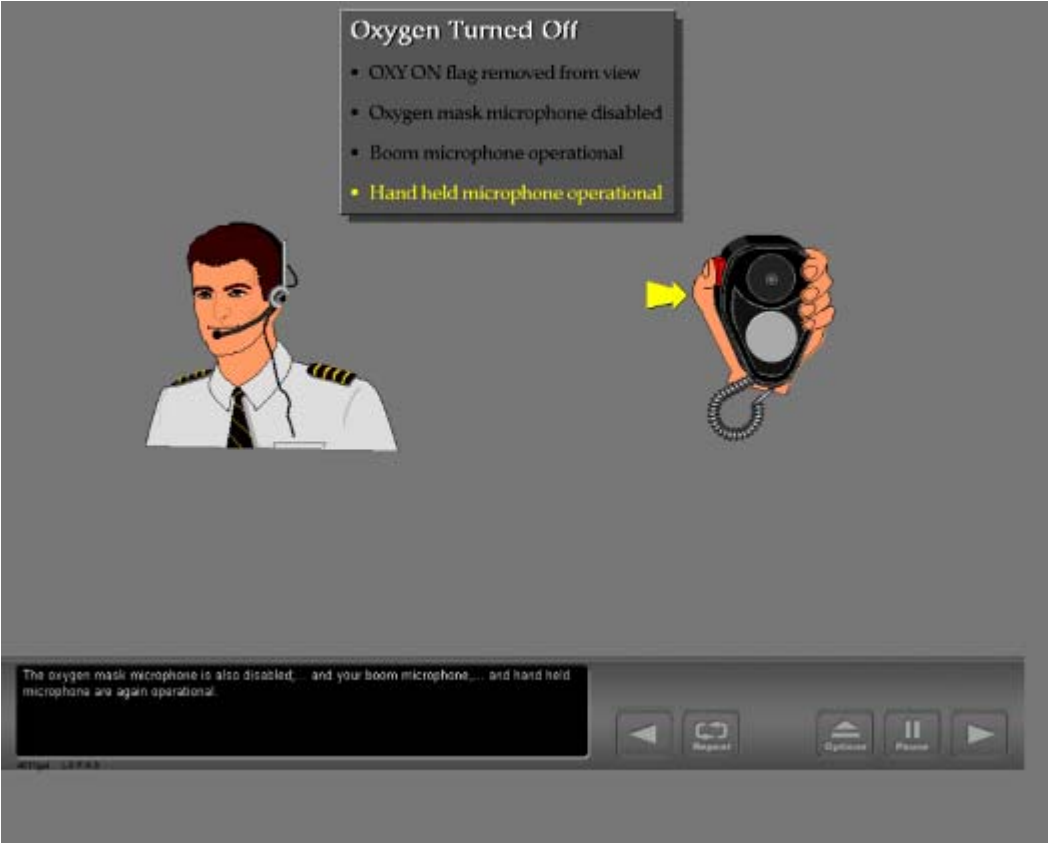
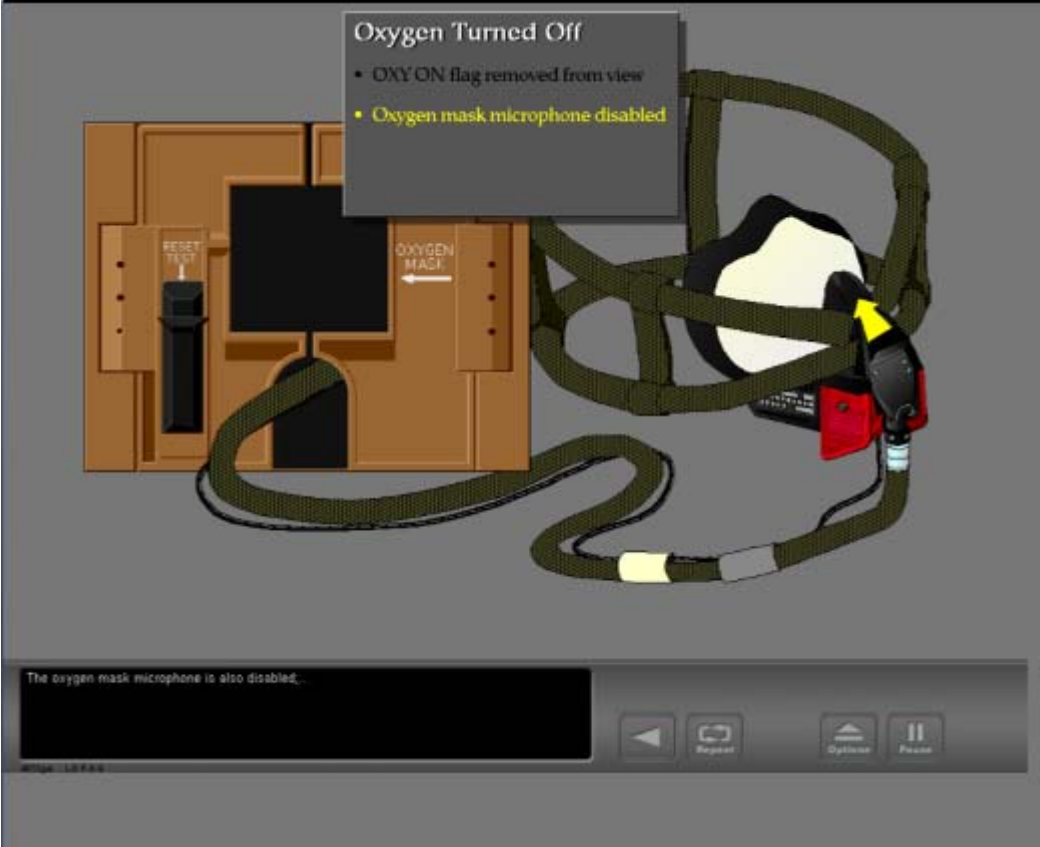

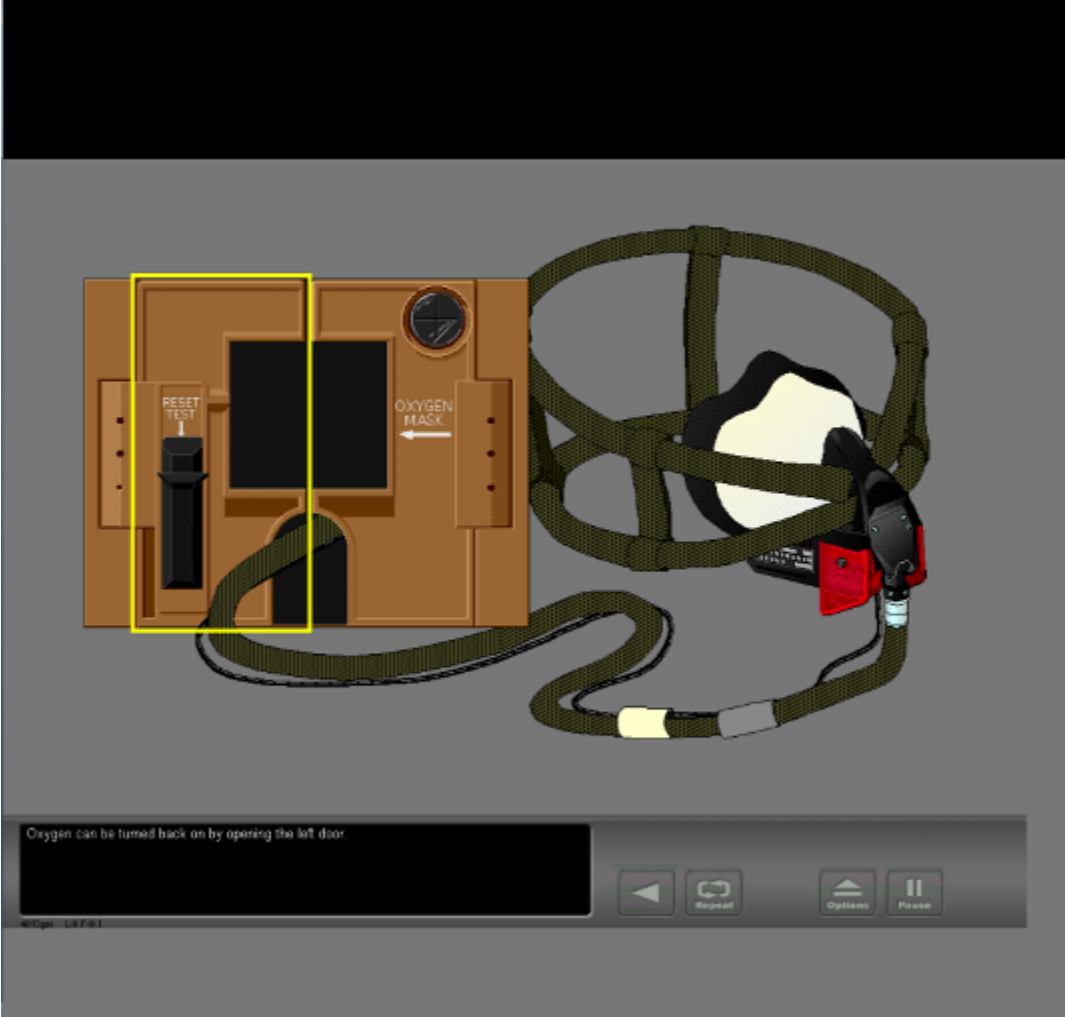

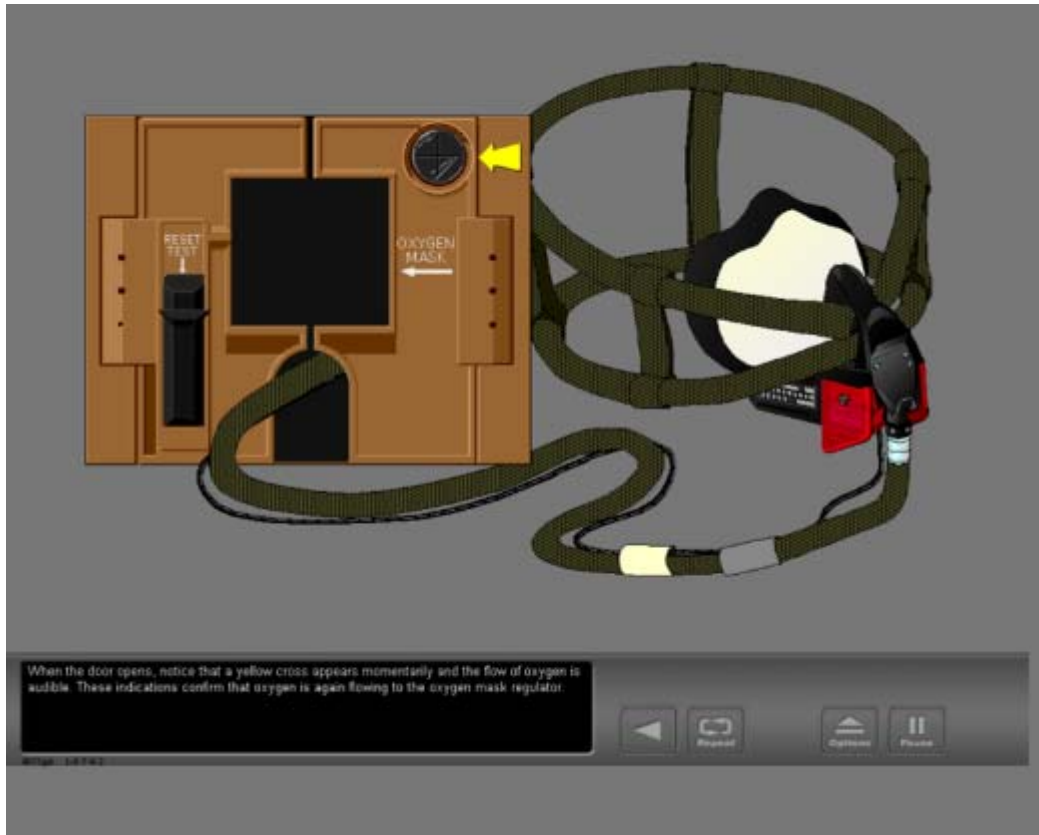

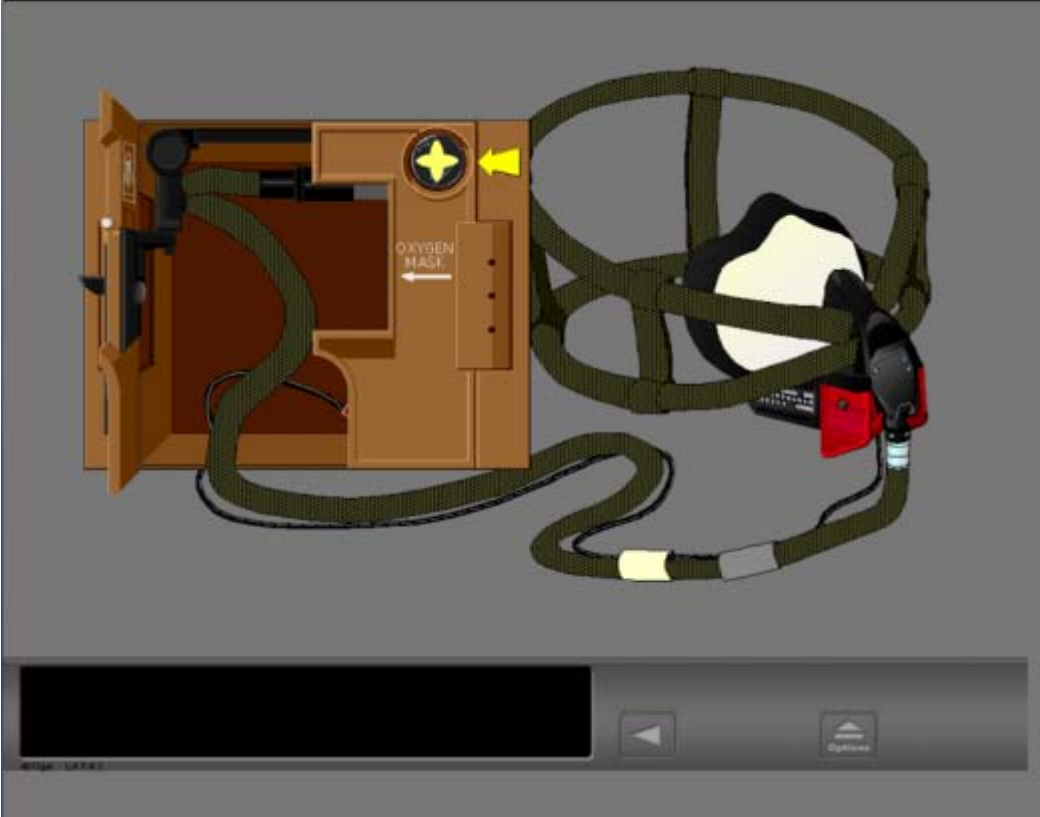





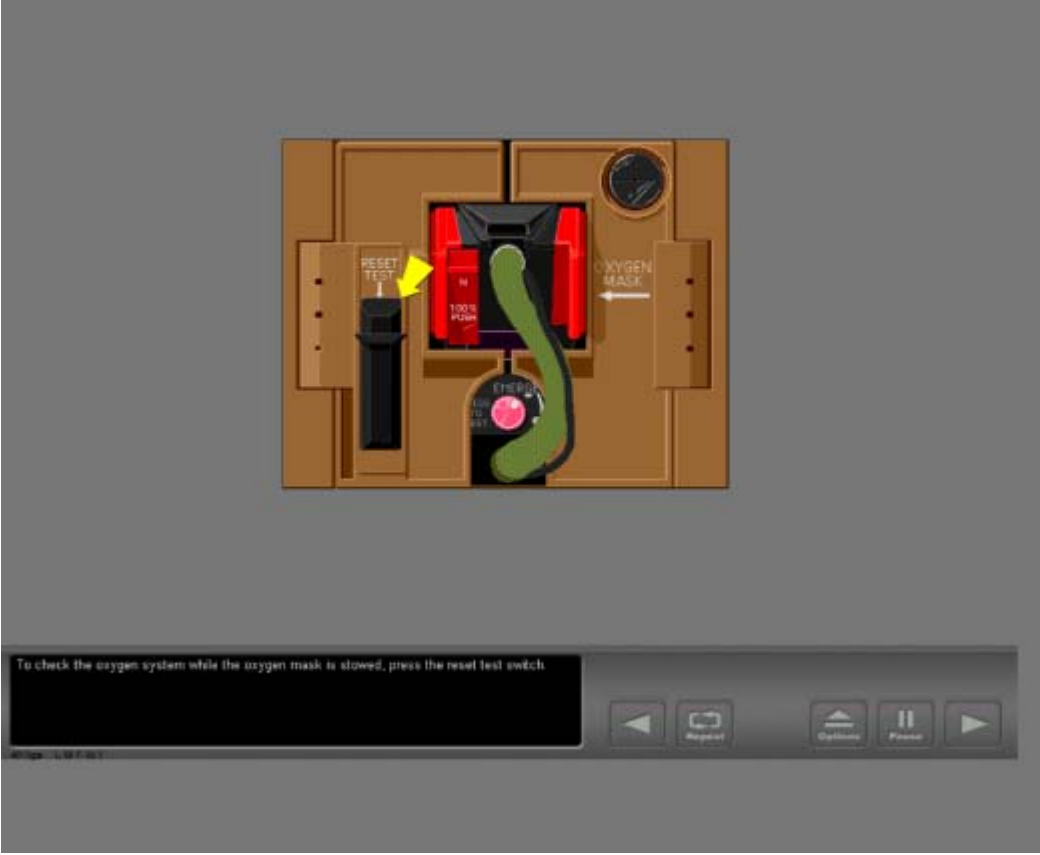



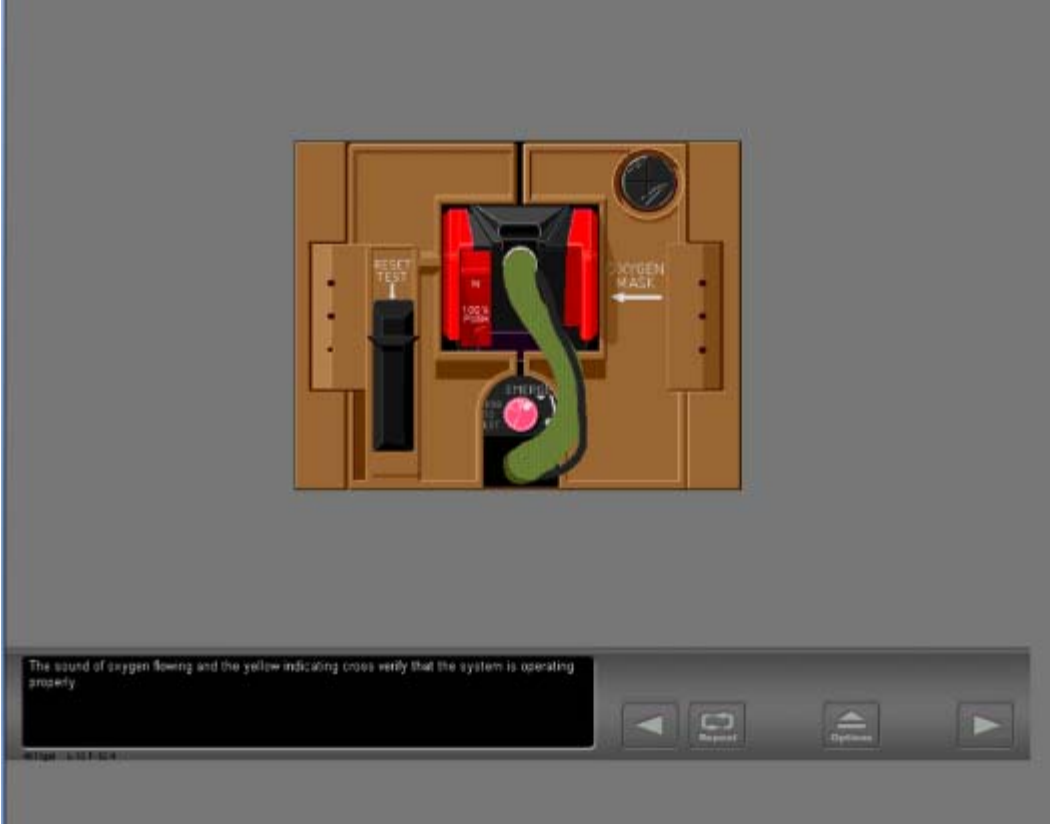









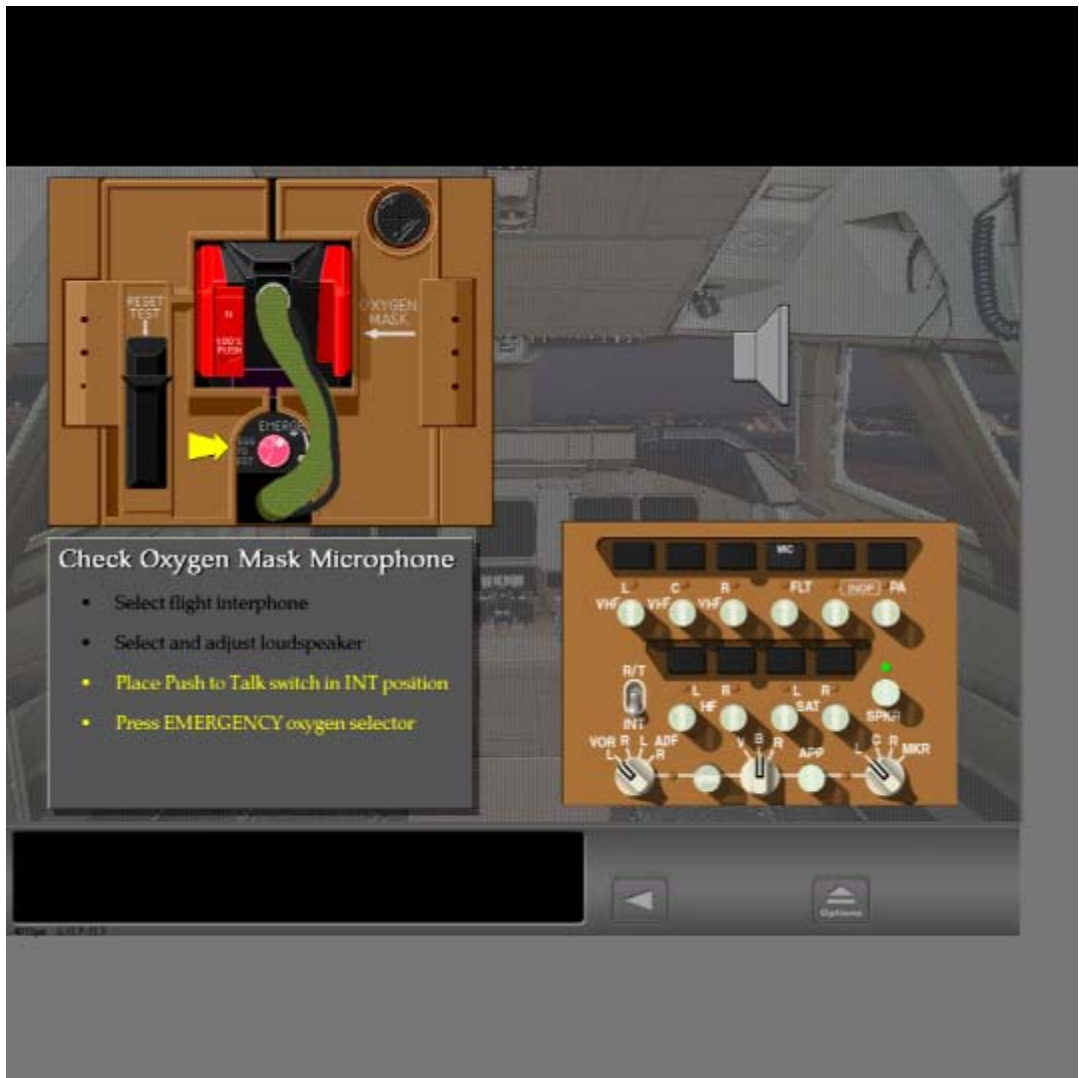

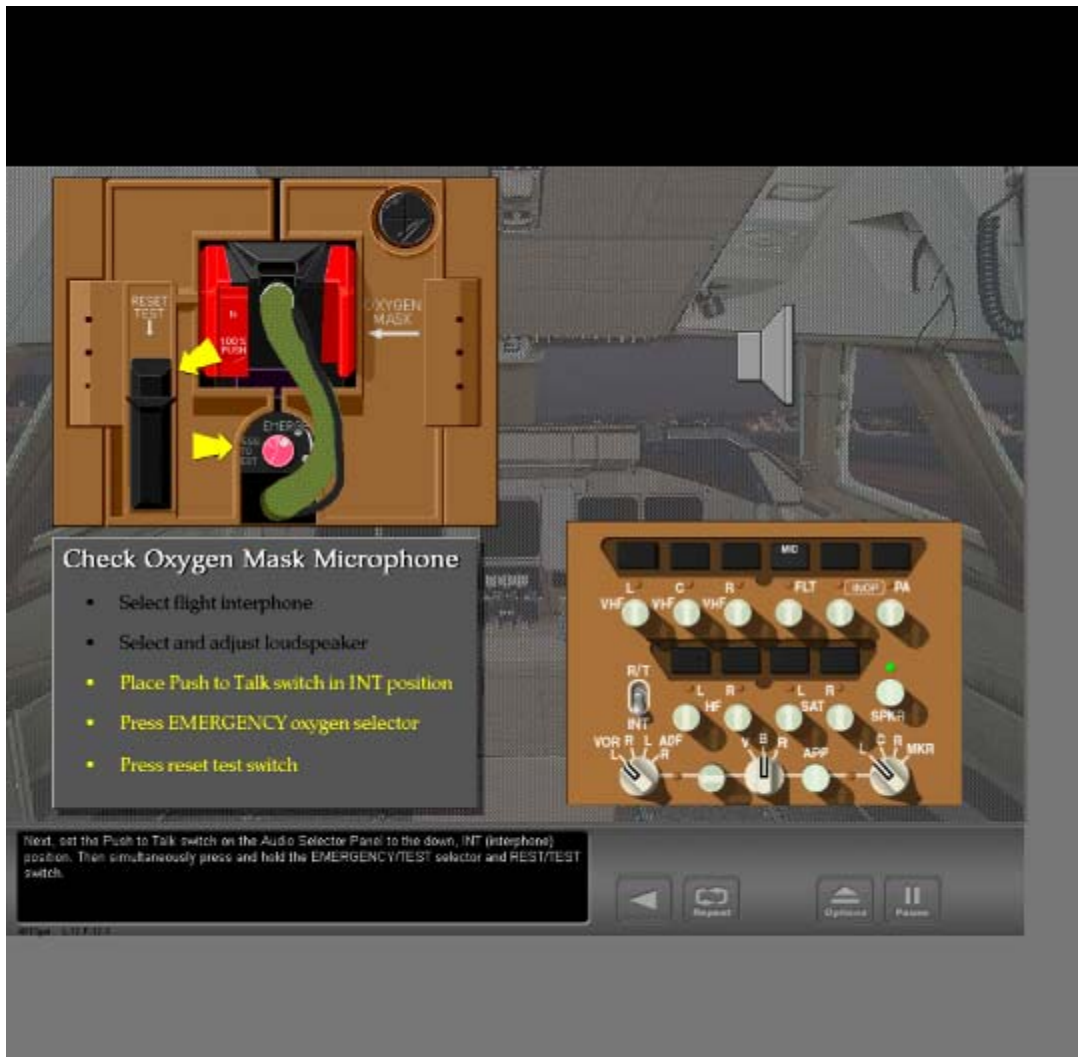

Check Oxygen Mask Microphone

- Select flight interphone
- Select and adjust loudspeaker
- Place Push to Talk switch in INT position
- Press EMERGENCY oxygen selector
- Press reset test switch

The sound of flowing oxygen should be audible over the flight deck loudspeaker, and the yellow indicating cross should appear.

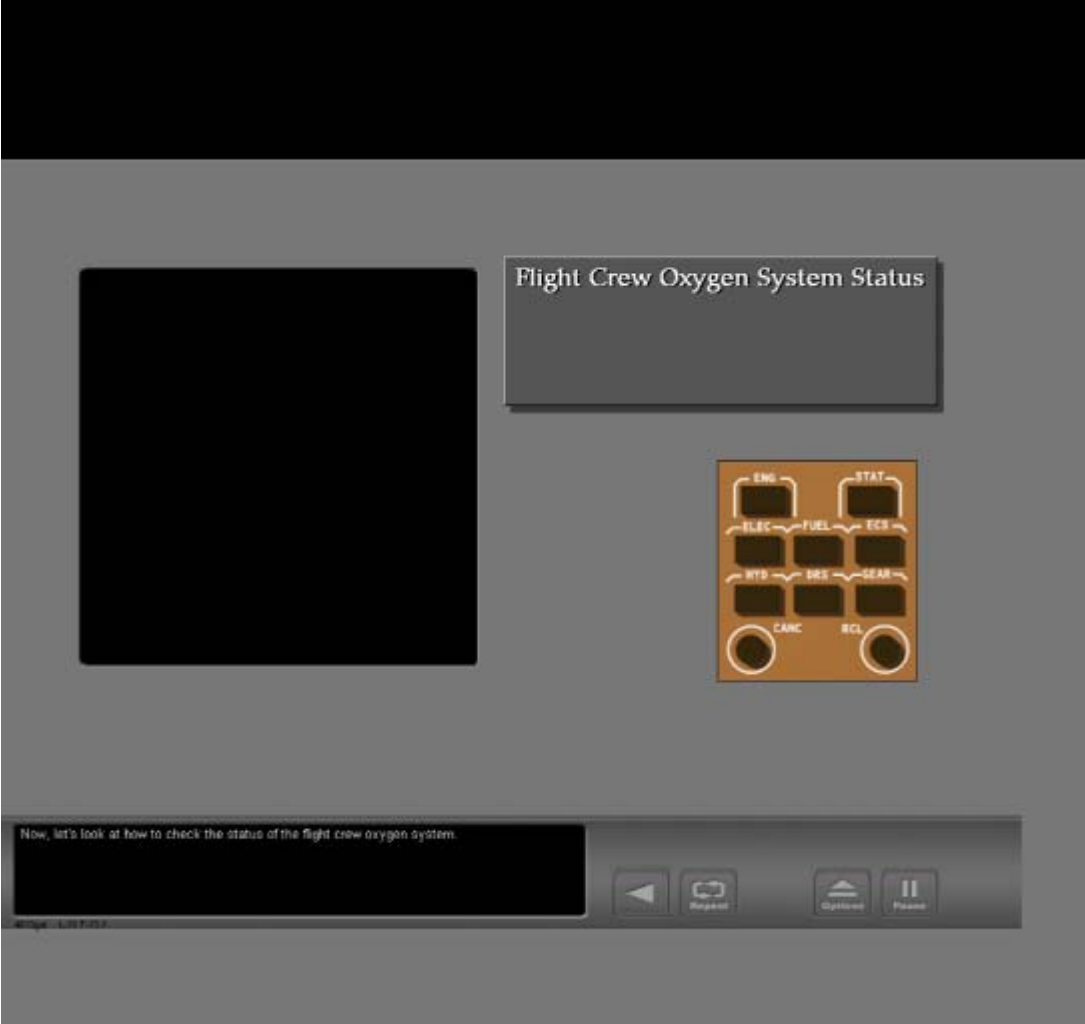

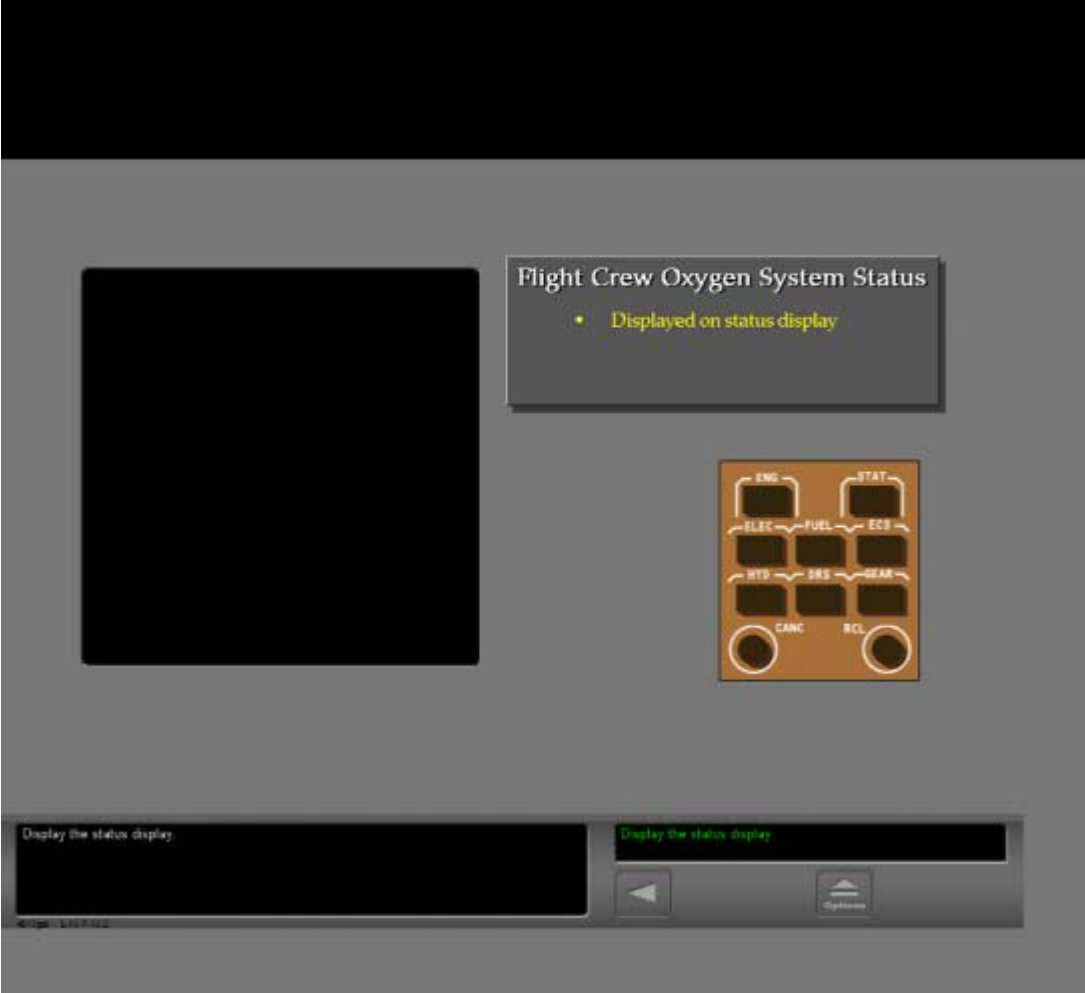

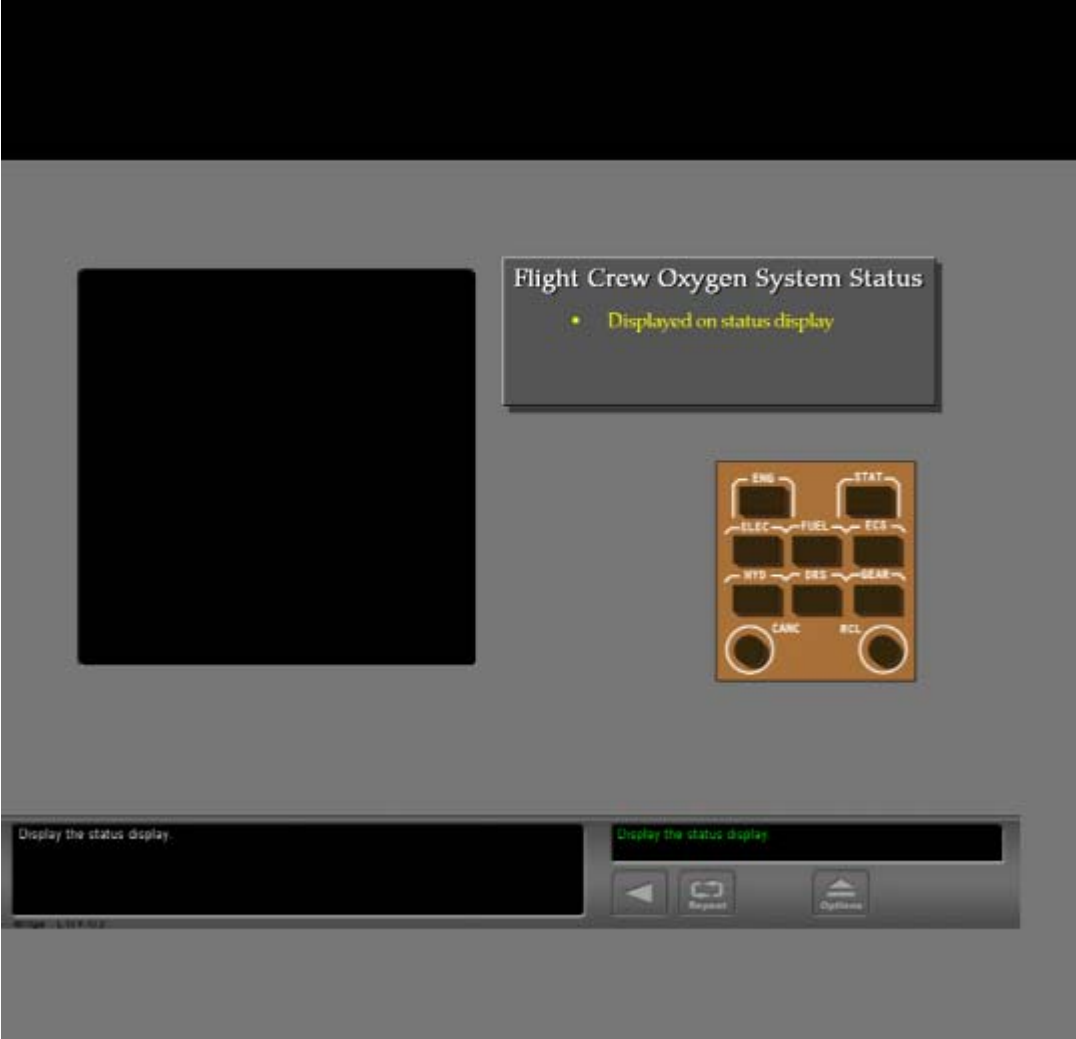

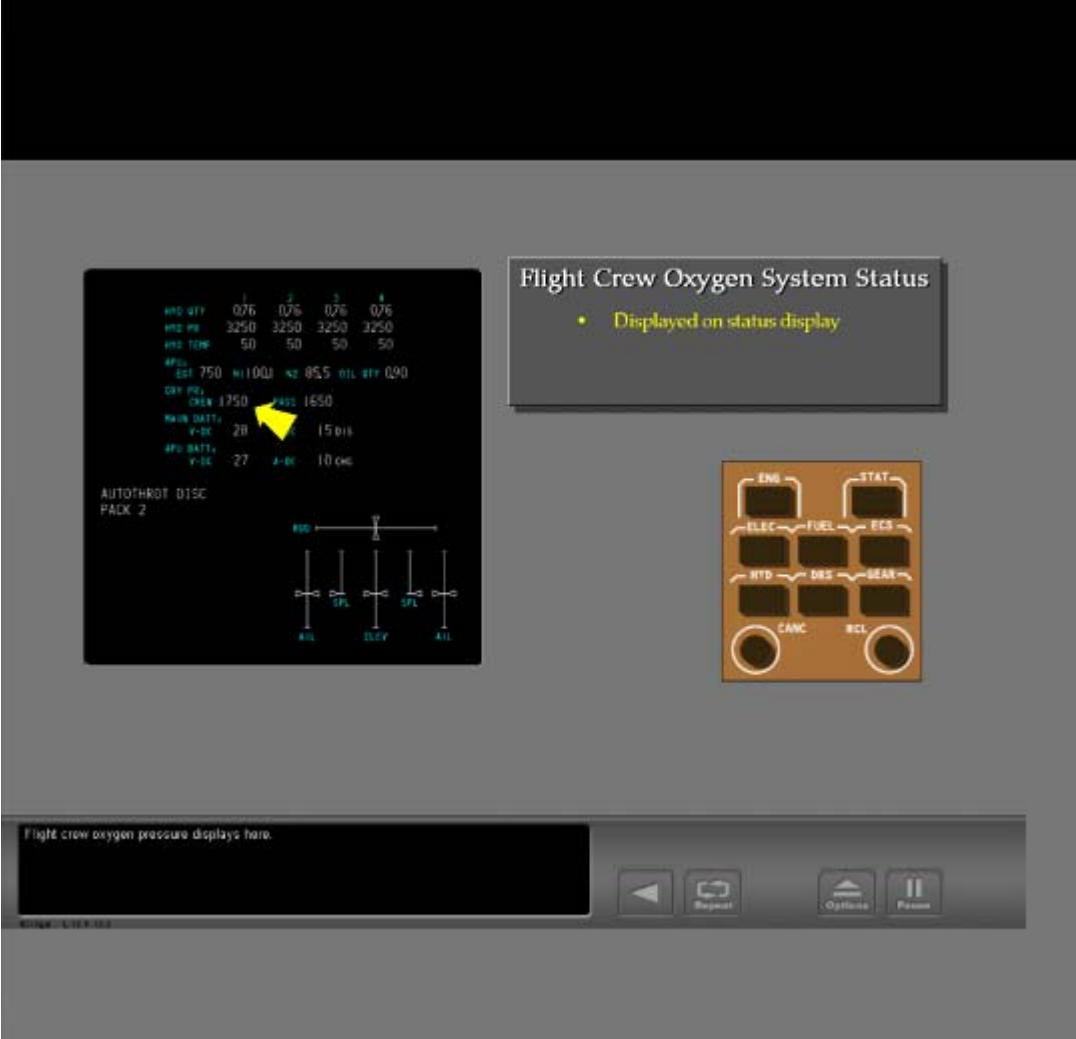

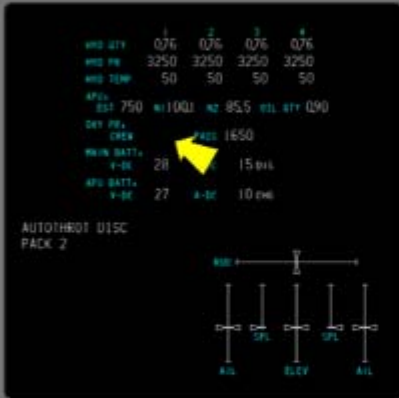

Flight Crew Oxygen System Status

- Displayed on status display
- Blank display indicates pressure signal not present or invalid



A blank oxygen pressure display indicates that a pressure signal is not present or the signal is invalid.



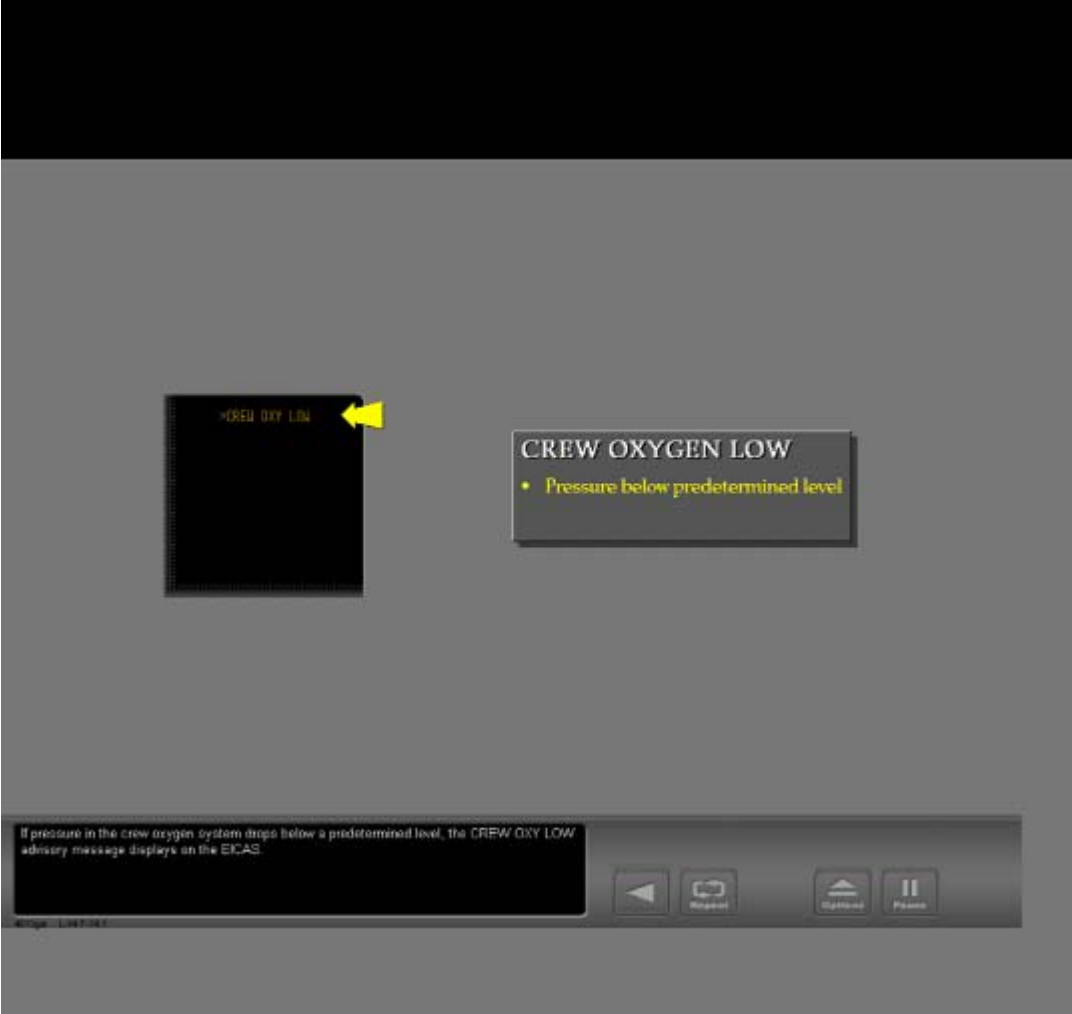

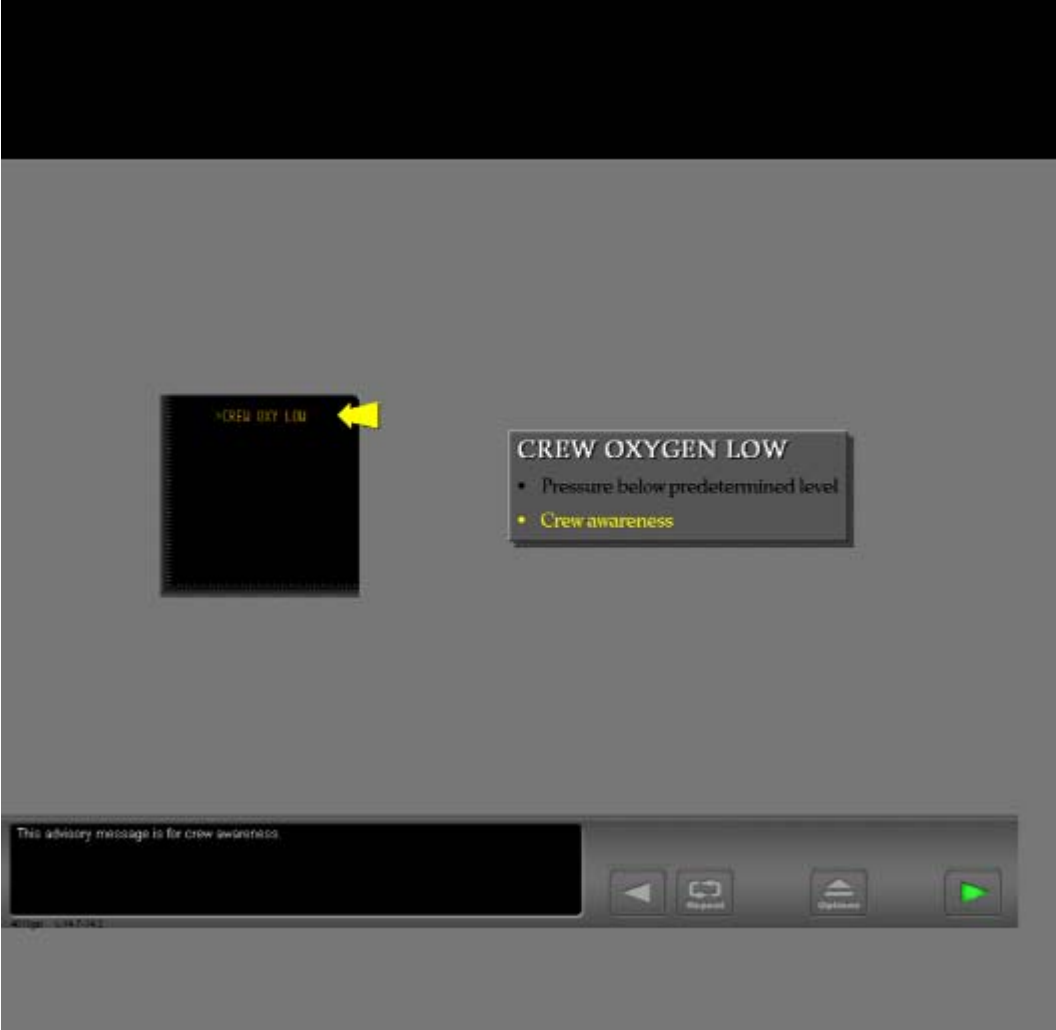

Supernumerary Oxygen System

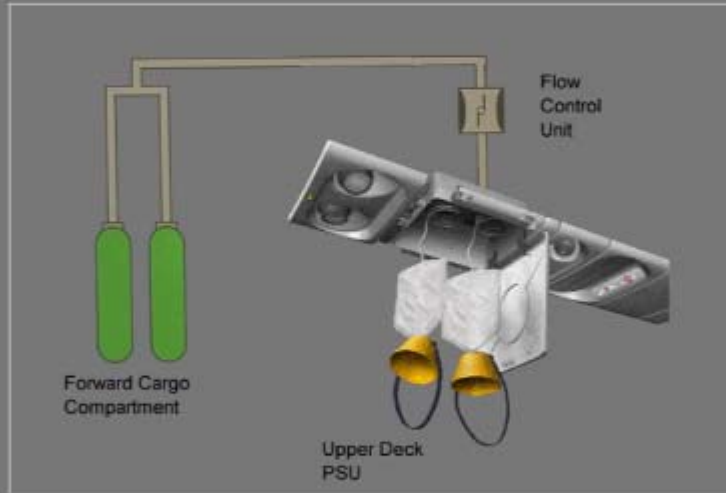

Supernumerary oxygen is provided by oxygen bottles, one flow control unit, and passenger service units, commonly referred to as PSUs. Each PSU contains oxygen masks. Supernumerary oxygen is available on the upper deck at the seats, each crew rest bunk, and the lavatory.



Supernumerary Oxygen System Status

Supernumerary Oxygen Supply

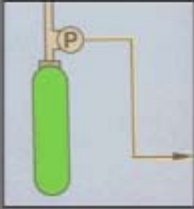

	1	2	3	4
WTD O2	0.76	0.76	0.76	0.76
WTD #	3250	3250	3250	3250
WTD TMR	50	50	50	50

APU
 EGT 750 NI 100 NI 85.5 OIL OIL 690

OXY PRESS
 O2PK 1750 PAOS 1750 ▶

MAIN BATT+
 V-BUS 28 A-BUS 15 BUS

APU BATT+
 V-BUS 27 A-BUS 10 BUS

AUTOTHROT DISC
 PACK 2

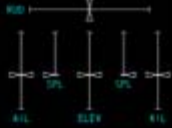

Supernumerary oxygen pressure is displayed on the EICAS STATUS page.



Supernumerary Oxygen System Status

Supernumerary Oxygen Supply

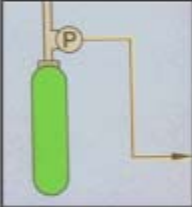

	1	2	3	4
HTD O/F	076	076	076	076
HTD PR	3250	3250	3250	3250
HTD TEMP	50	50	50	50
APU				
EST	750	1100	855	090
DIRT P/W				
DIRT	1750	PRSS 1750	←	
MAIN BATT				
V-DC	28	A-DC	15 bits	
APU BATT				
V-DC	27	A-DC	10 bits	

AUTOTHROT DISC
PACK 2



Supernumerary oxygen pressure is displayed on the EICAS STATUS page.



Supernumerary Oxygen System Automatic Operation

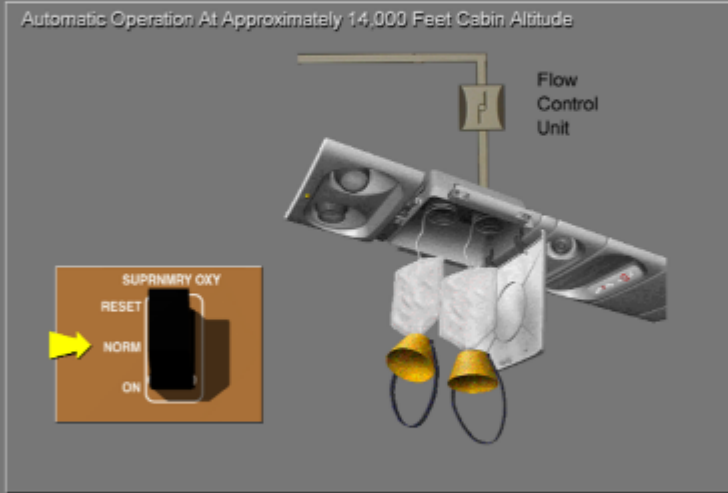

The SUPERNMRY OXY switch has three positions. When the switch is guarded to NORM, and cabin altitude reaches approximately 14,000 feet, the flow control unit automatically opens and the masks drop from the PSUs.



Wikipedia: S15F354

Supernumerary Oxygen System Manual Operation

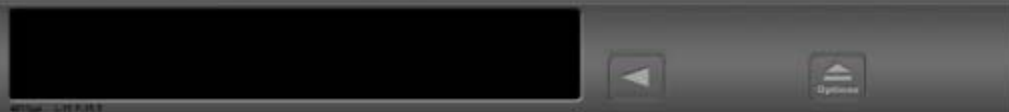
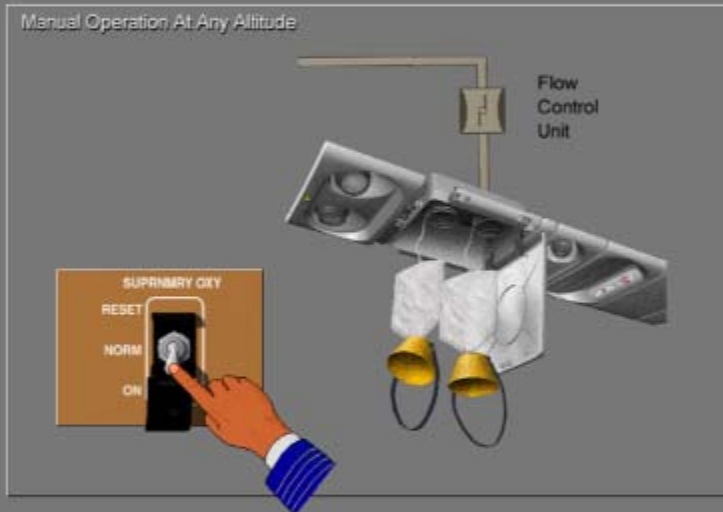

Supernumerary Oxygen System Manual Operation

Manual Operation At Any Altitude

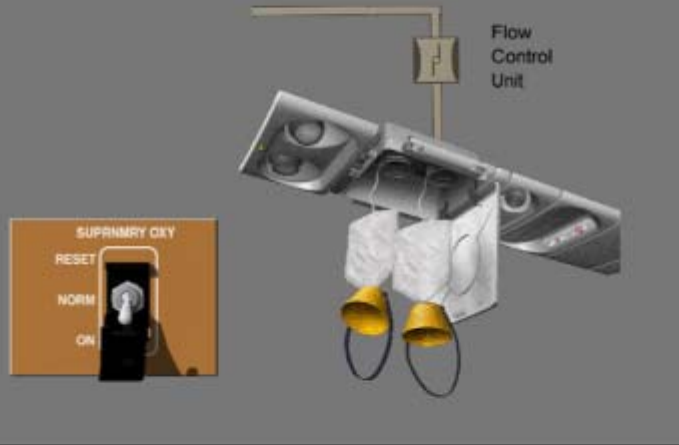

Manual operation is available at any altitude by opening the switch guard and placing the SUPERNMRY OXY switch to ON. The flow control unit automatically opens and the masks drop from the PSUs.



Supernumerary Oxygen

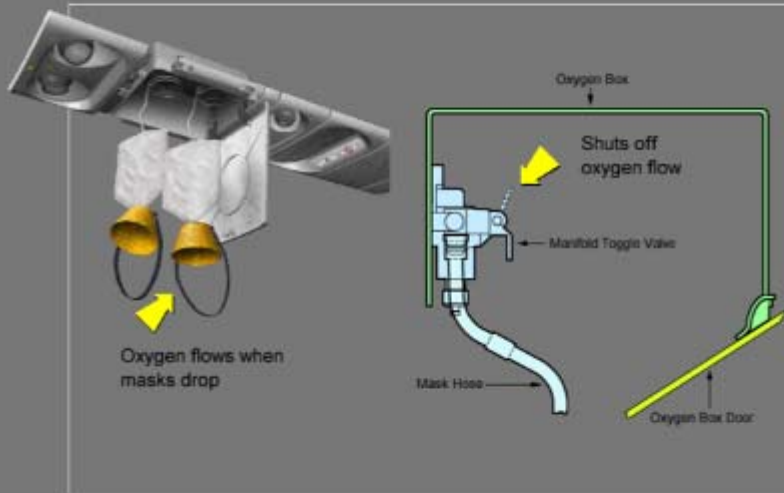

Oxygen flow to a mask begins immediately when the mask drops. The supernumerary oxygen system provides 155 minutes of oxygen at a cabin altitude of 25,000 feet. When an oxygen mask is not in use, the manifold toggle valve in the PSU should be in the CLOSE position.



Supernumerary Oxygen System Thermal Relief

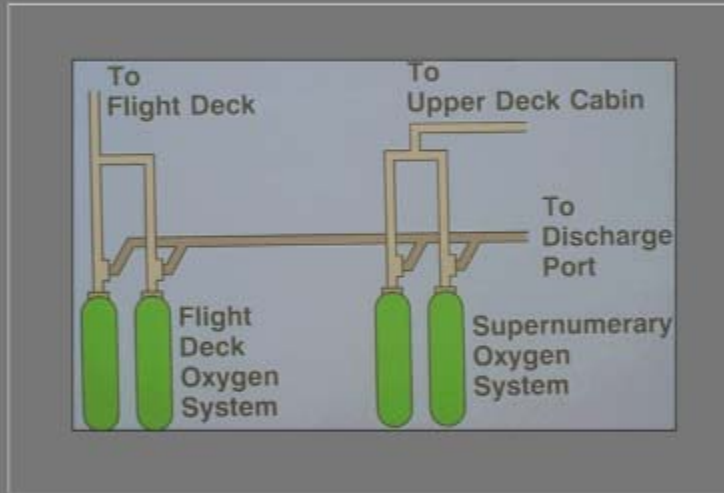

The supernumerary oxygen system, like the flight deck oxygen system, is connected to a common discharge line for thermal relief.



Supernumerary Oxygen System Thermal Relief



The discharge port is covered by a green disk located just aft of the forward cargo door. The absence of the disk indicates one or more of the oxygen bottles has thermally discharged.

End of
Topic

