

Docket No. SA-509

Exhibit No. 5-H

NATIONAL TRANSPORTATION SAFETY BOARD

Washington D.C.

Wind Vector and Alarm Plots Low Level Windshear Alert System CLT

CHARLOTTE INTL AIRPORT
DATE: 7/ 2/94
TIME: 22:39: 7

STATION	○
STATION ALARM	●
EDGE ALARM	—
TRIANGLE ALARM	▴
WIND VECTOR	→
RUNWAY	▬

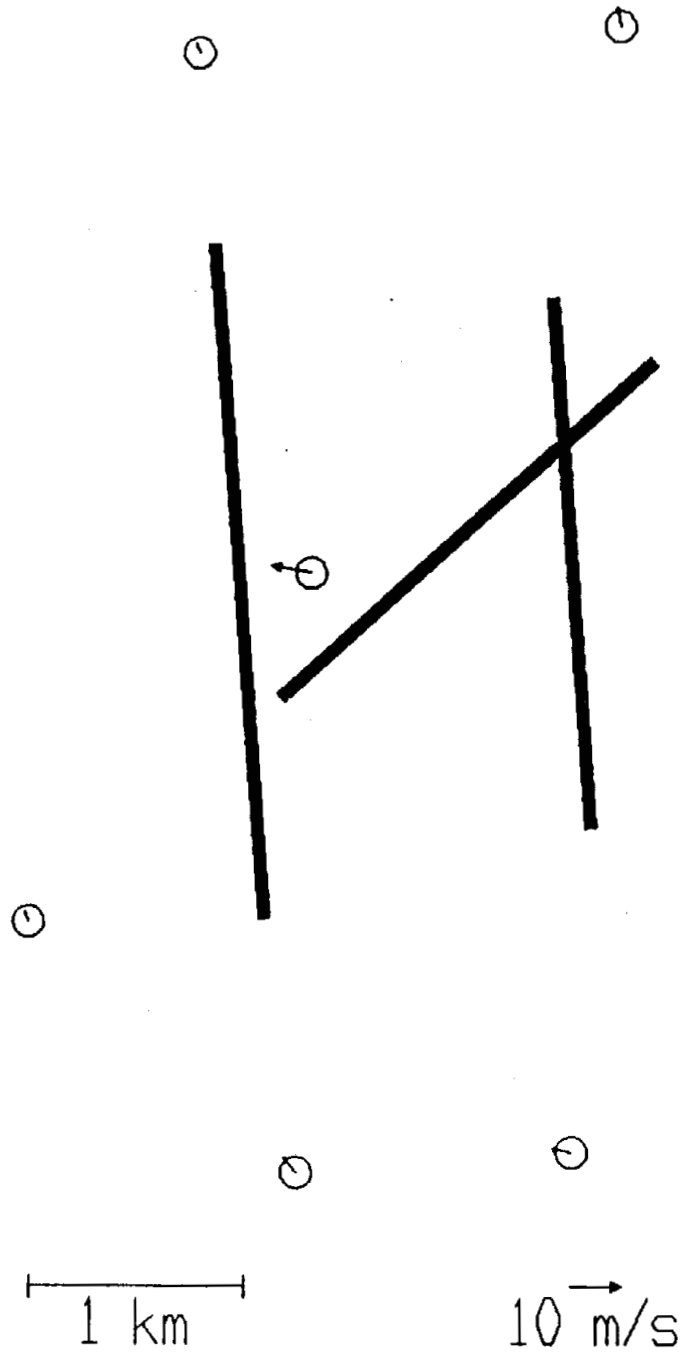

FAA TECHNICAL CENTER
7/7/94



CHARLOTTE INTL AIRPORT

DATE: 7/ 2/94

TIME: 22:39:17

STATION



STATION ALARM



EDGE ALARM



TRIANGLE ALARM



WIND VECTOR



RUNWAY

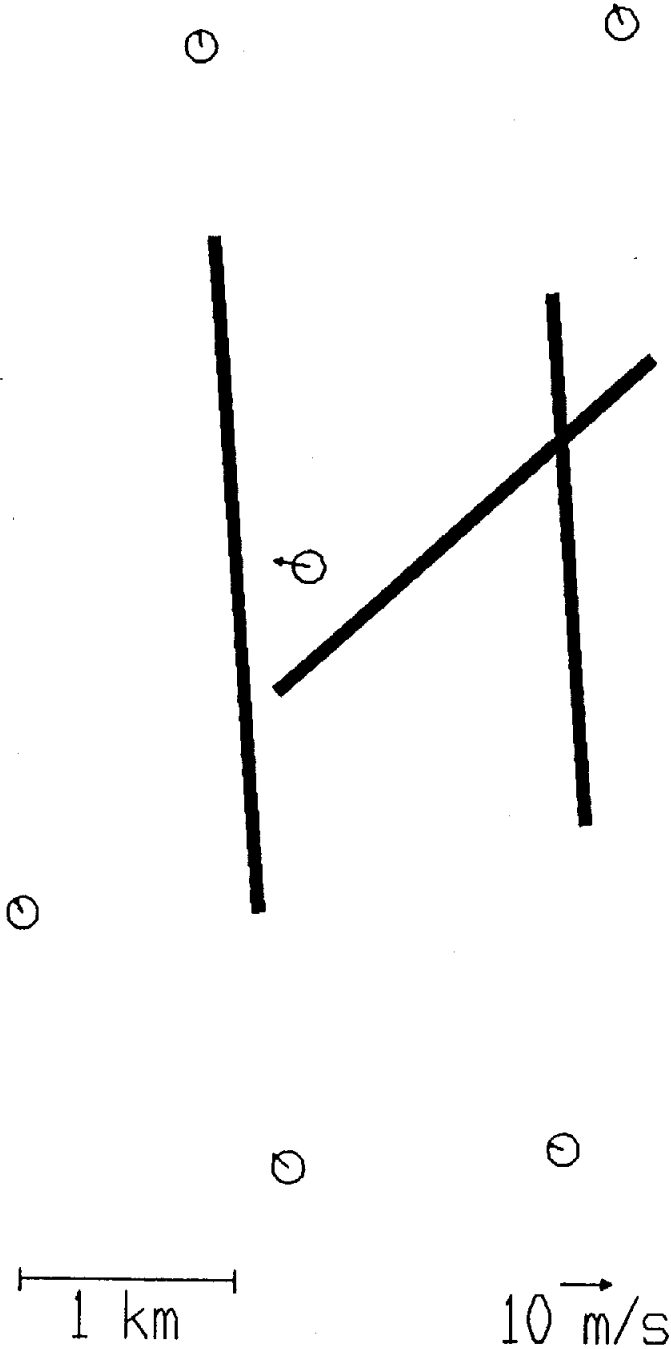

FAA TECHNICAL CENTER
7/7/94

2

CHARLOTTE INTL AIRPORT
DATE: 7/ 2/94
TIME: 22:39:27

- STATION
- STATION ALARM
- EDGE ALARM
- ▴ TRIANGLE ALARM
- ↑ WIND VECTOR
- RUNWAY

3

FAA TECHNICAL CENTER
7/7/94

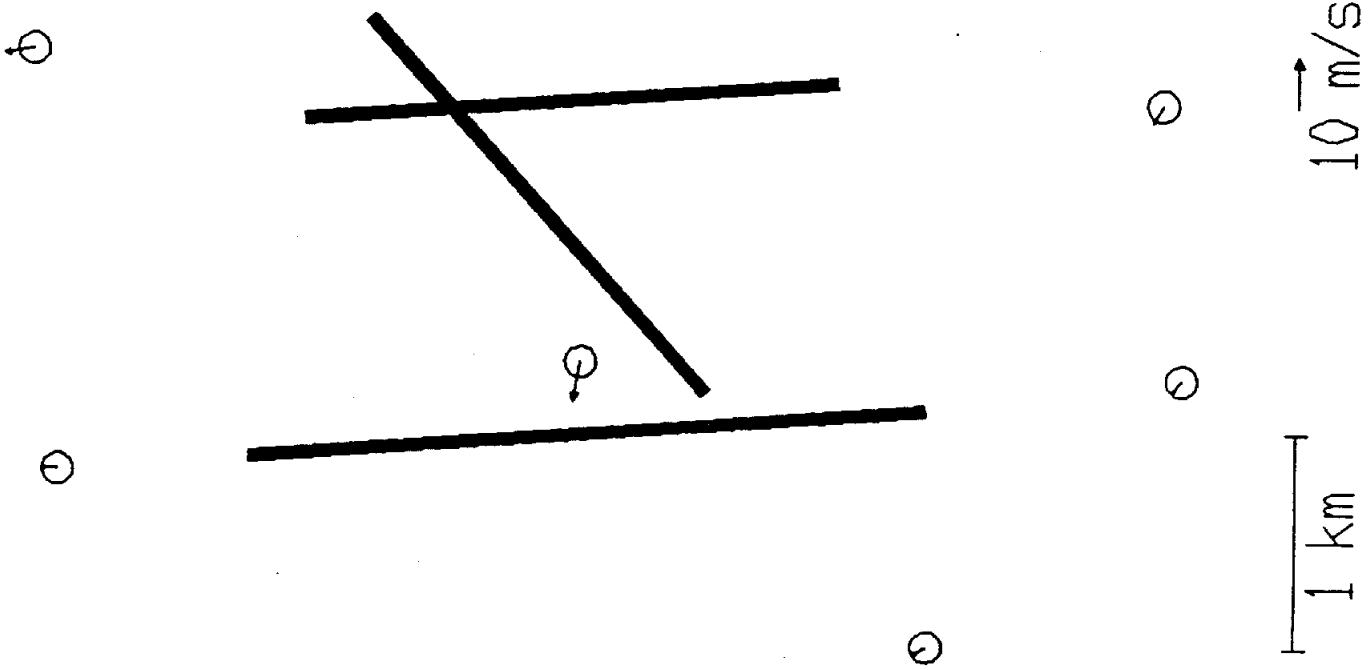

CHARLOTTE INTL AIRPORT

DATE: 7/2/94

TIME: 22:39:37

STATION



STATION ALARM



EDGE ALARM



TRIANGLE ALARM



WIND VECTOR

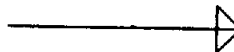

RUNWAY

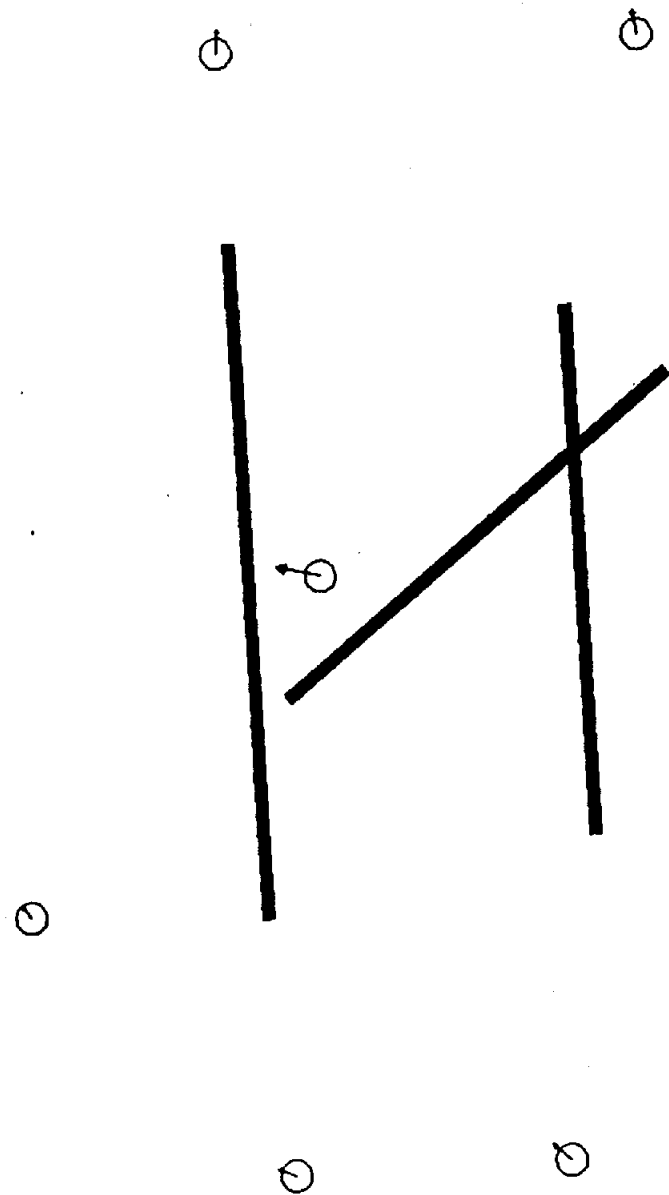

1 km

10 m/s

FAA TECHNICAL CENTER
7/7/94

4

CHARLOTTE INTL AIRPORT

DATE: 7/ 2/94

TIME: 22:39:47

STATION



STATION ALARM



EDGE ALARM



TRIANGLE ALARM



WIND VECTOR

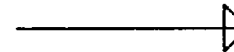

RUNWAY

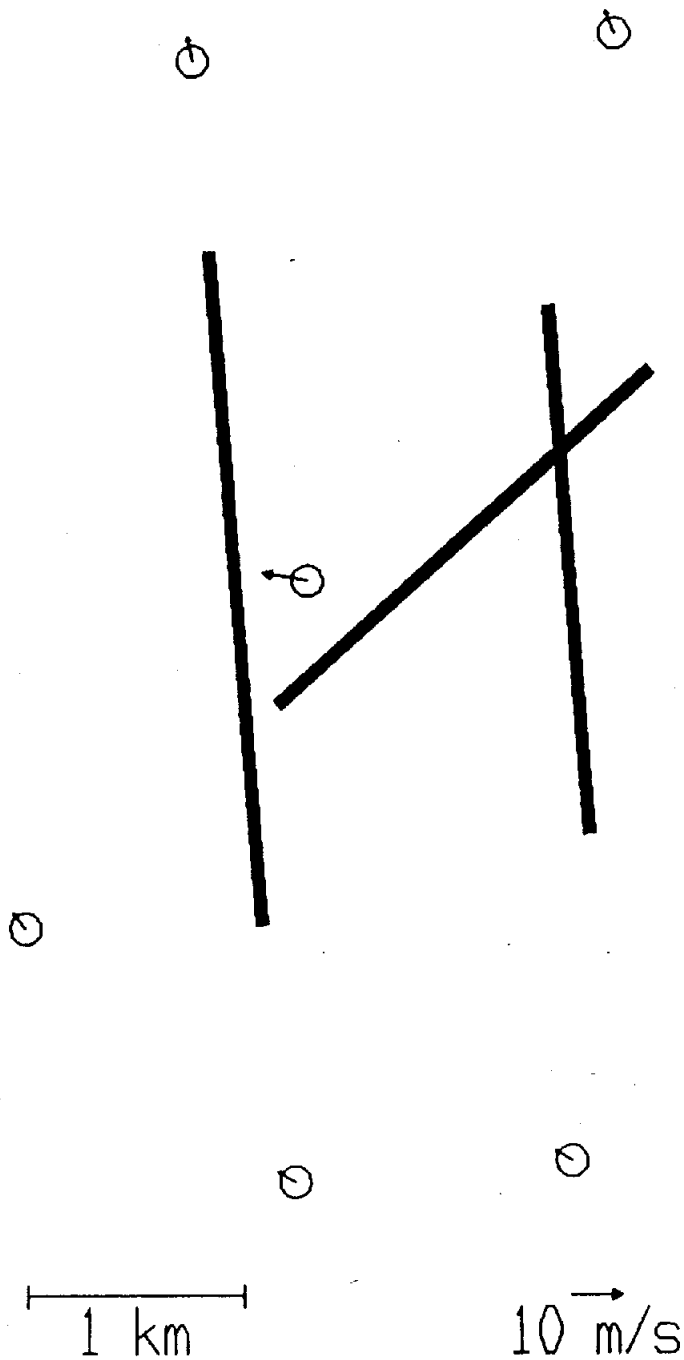

FAA TECHNICAL CENTER
7/7/94

5

CHARLOTTE INTL AIRPORT

DATE: 7/2/94

TIME: 22:39:57

STATION



STATION ALARM



EDGE ALARM



TRIANGLE ALARM



WIND VECTOR

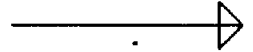

RUNWAY

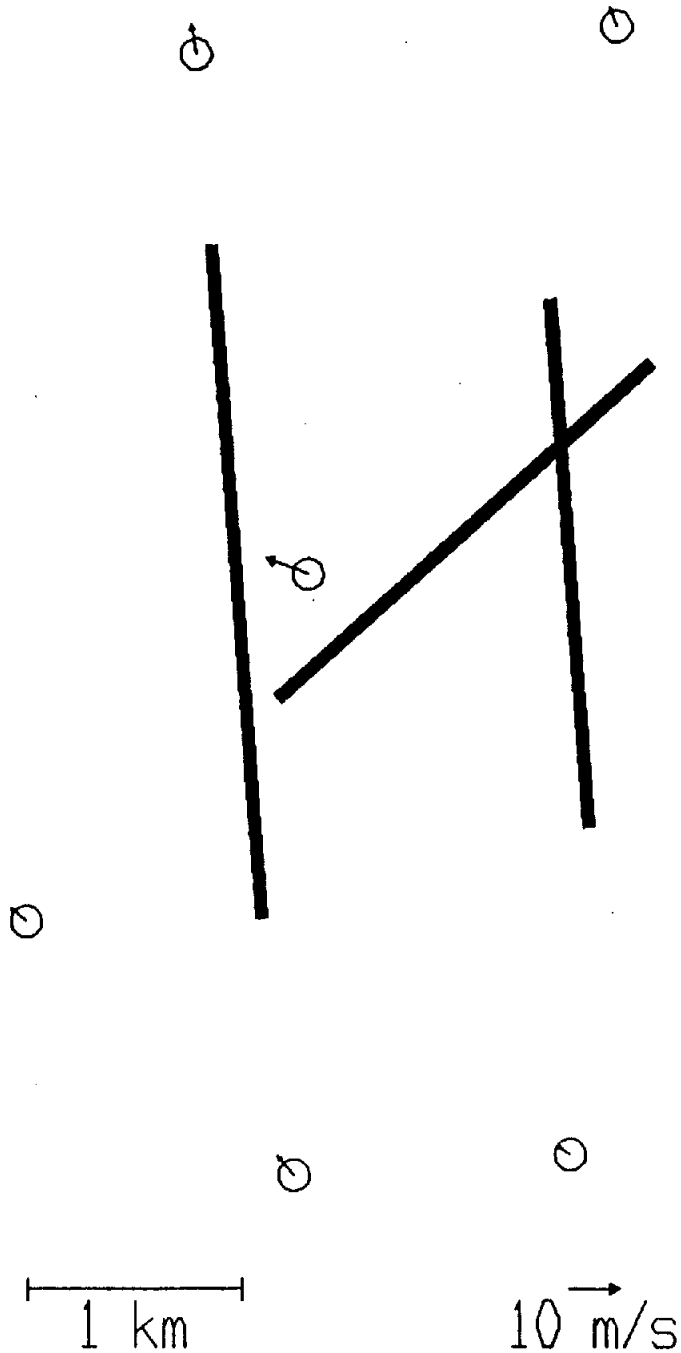

FAA TECHNICAL CENTER
7/7/94

6

CHARLOTTE INTL AIRPORT
DATE: 7/ 2/94
TIME: 22:40: 7

STATION ○

STATION ALARM ●

EDGE ALARM —

TRIANGLE ALARM ▴

WIND VECTOR →

RUNWAY —

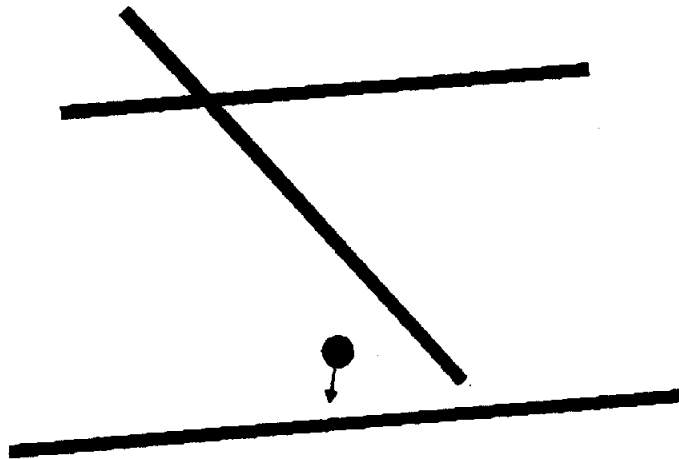

1 km

10 m/s

7

FMA TECHNICAL CENTER
7/7/94

CHARLOTTE INTL AIRPORT
DATE: 7/ 2/94
TIME: 22:40:17

STATION	○
STATION ALARM	●
EDGE ALARM	—
TRIANGLE ALARM	▴
WIND VECTOR	→
RUNWAY	▬

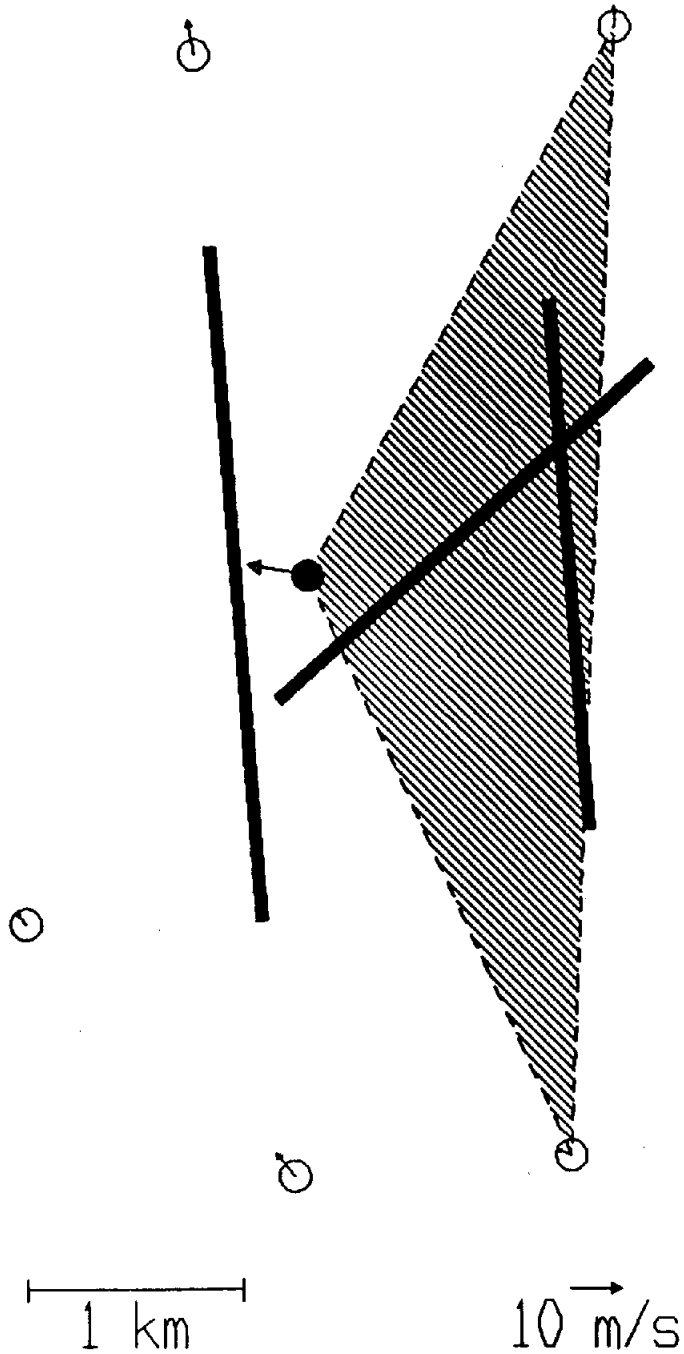

FAA TECHNICAL CENTER
7/7/94

8

CHARLOTTE INTL AIRPORT
DATE: 7/ 2/94
TIME: 22:40:27

STATION	○
STATION ALARM	●
EDGE ALARM	—
TRIANGLE ALARM	▴
WIND VECTOR	→
RUNWAY	▬

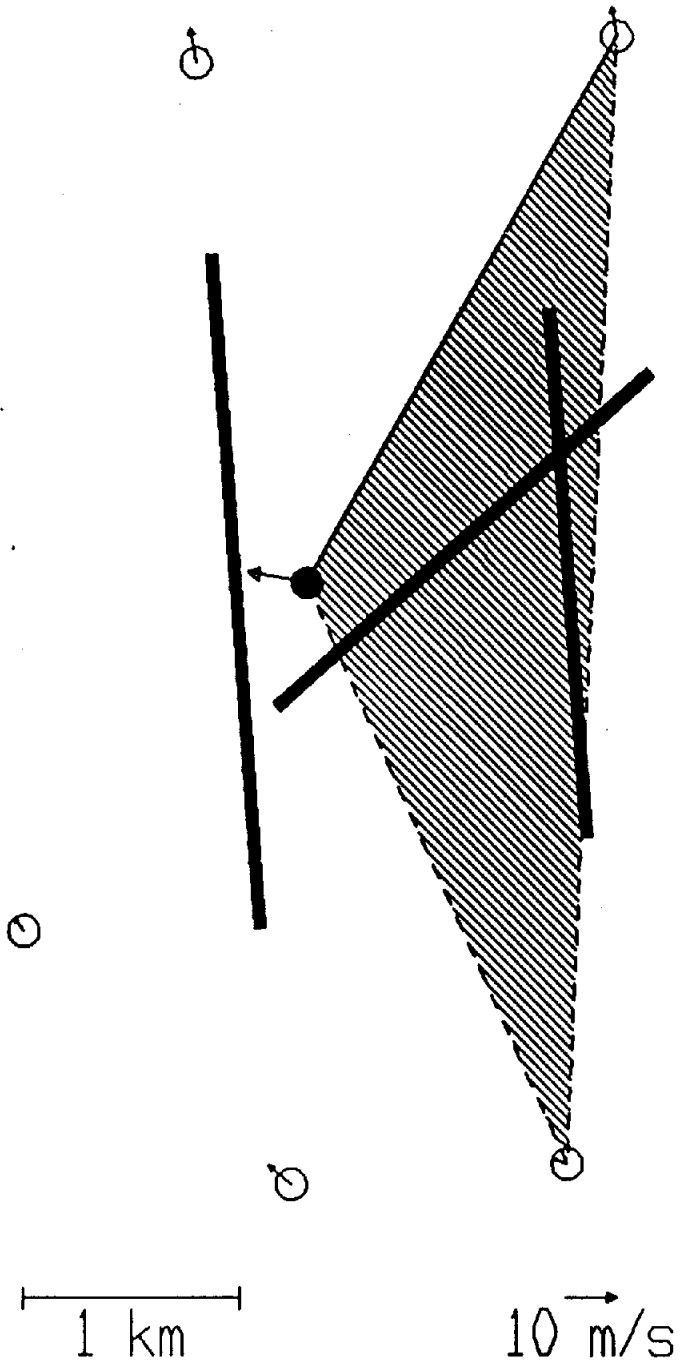

FAA TECHNICAL CENTER
7/7/94

9

CHARLOTTE INTL AIRPORT

DATE: 7/ 2/94

TIME: 22:40:37

STATION



STATION ALARM



EDGE ALARM



TRIANGLE ALARM



WIND VECTOR

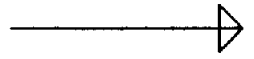

RUNWAY

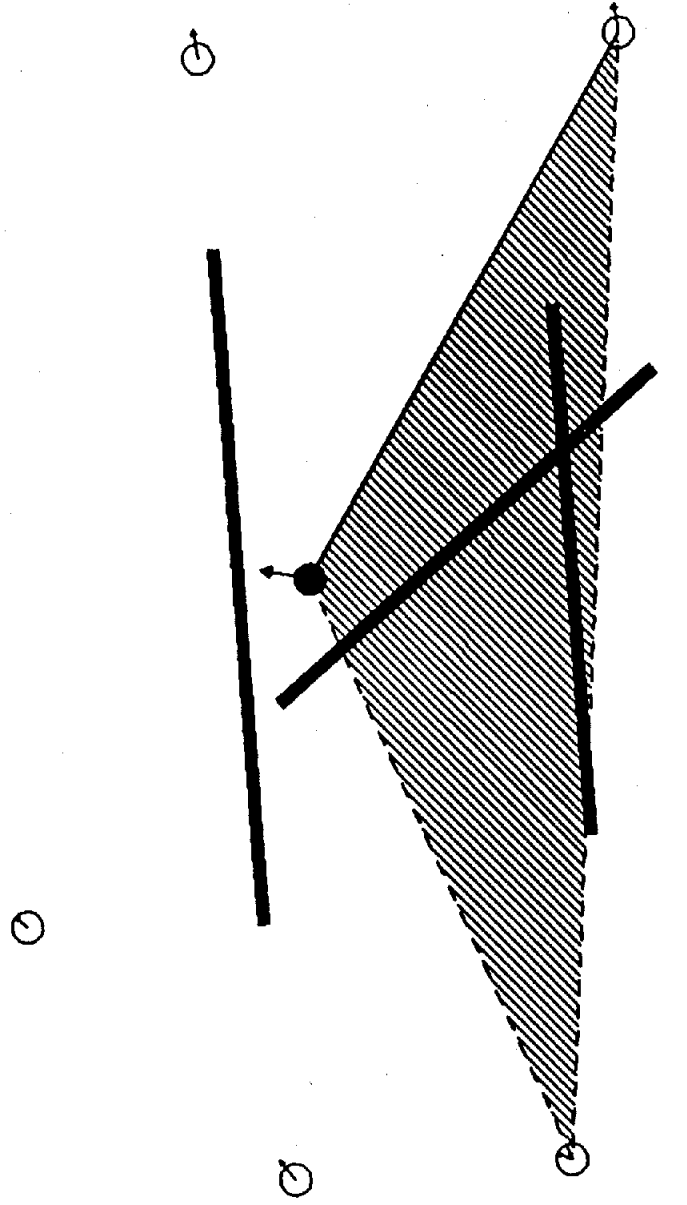

1 km

10 m/s

FAA TECHNICAL CENTER
7/7/94

10

CHARLOTTE INTL AIRPORT

DATE: 7/ 2/94

TIME: 22:40:47

STATION



STATION ALARM



EDGE ALARM



TRIANGLE ALARM



WIND VECTOR

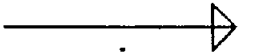

RUNWAY

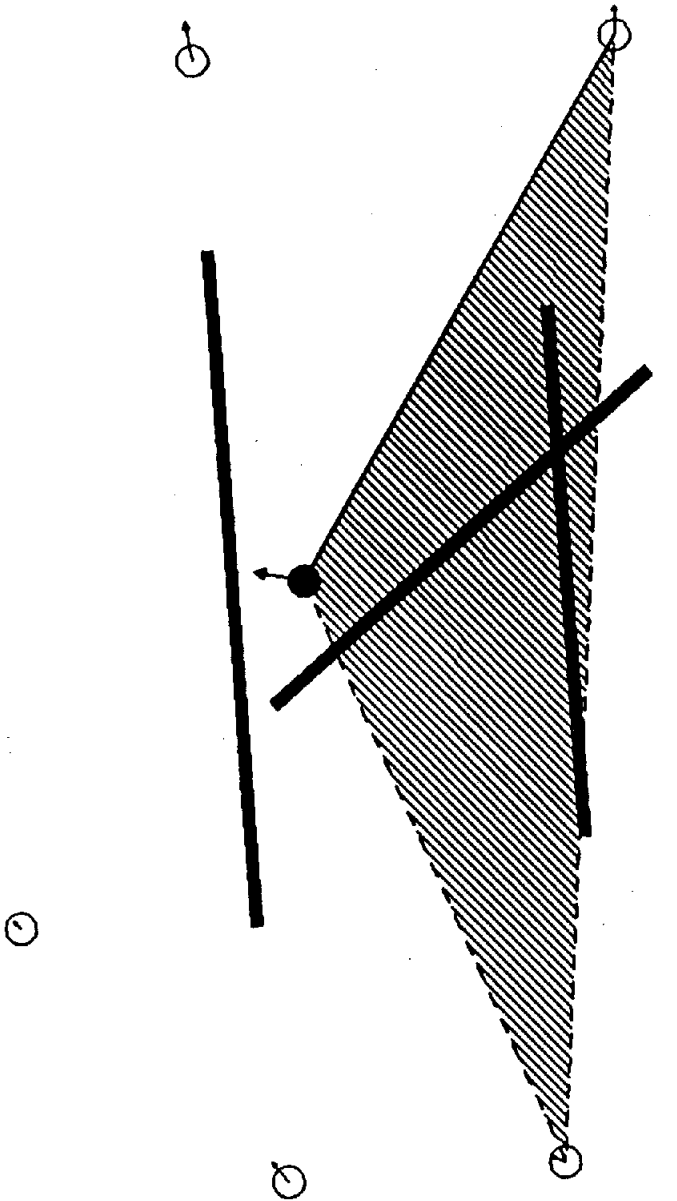



1 km

10 m/s

FAA TECHNICAL CENTER
7/7/94

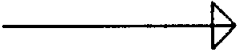

CHARLOTTE INTL AIRPORT
DATE: 7/ 2/94
TIME: 22:40:57

- STATION ○
- STATION ALARM ●
- EDGE ALARM ———
- TRIANGLE ALARM 
- WIND VECTOR 
- RUNWAY 

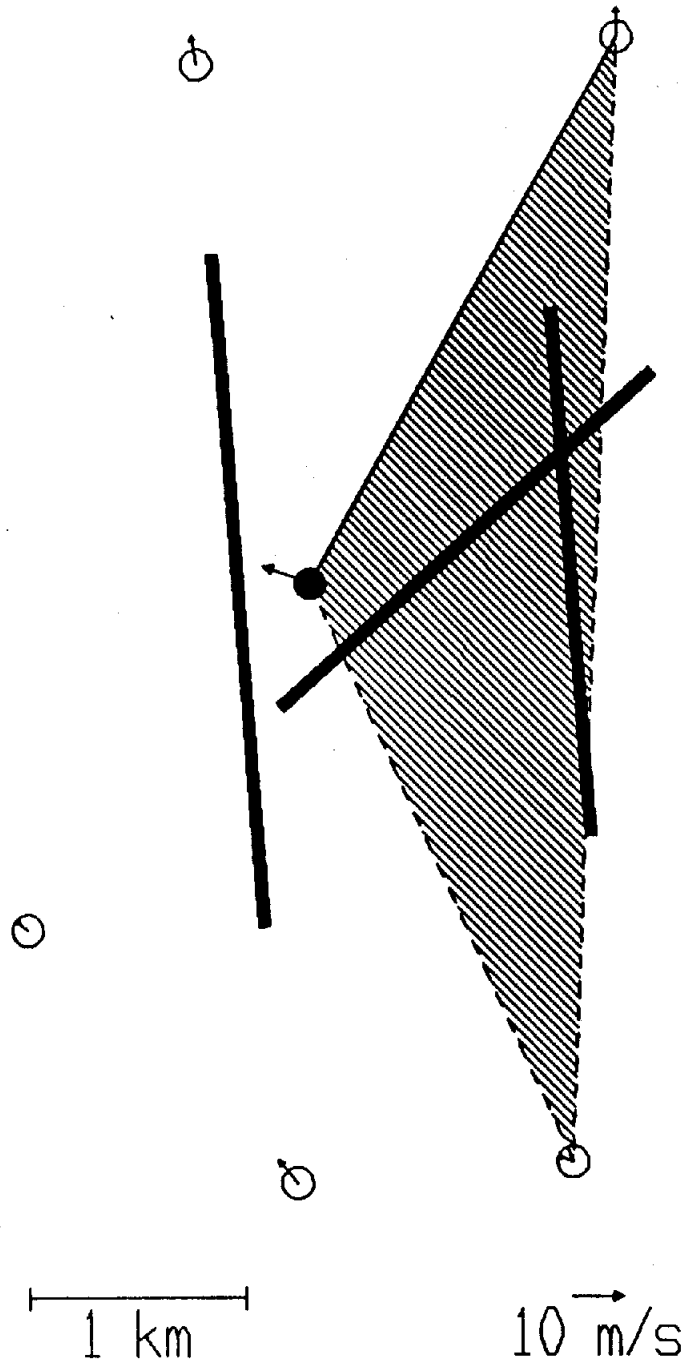

FAA TECHNICAL CENTER
7/7/94

12

CHARLOTTE INTL AIRPORT
DATE: 7/ 2/94
TIME: 22:41: 7

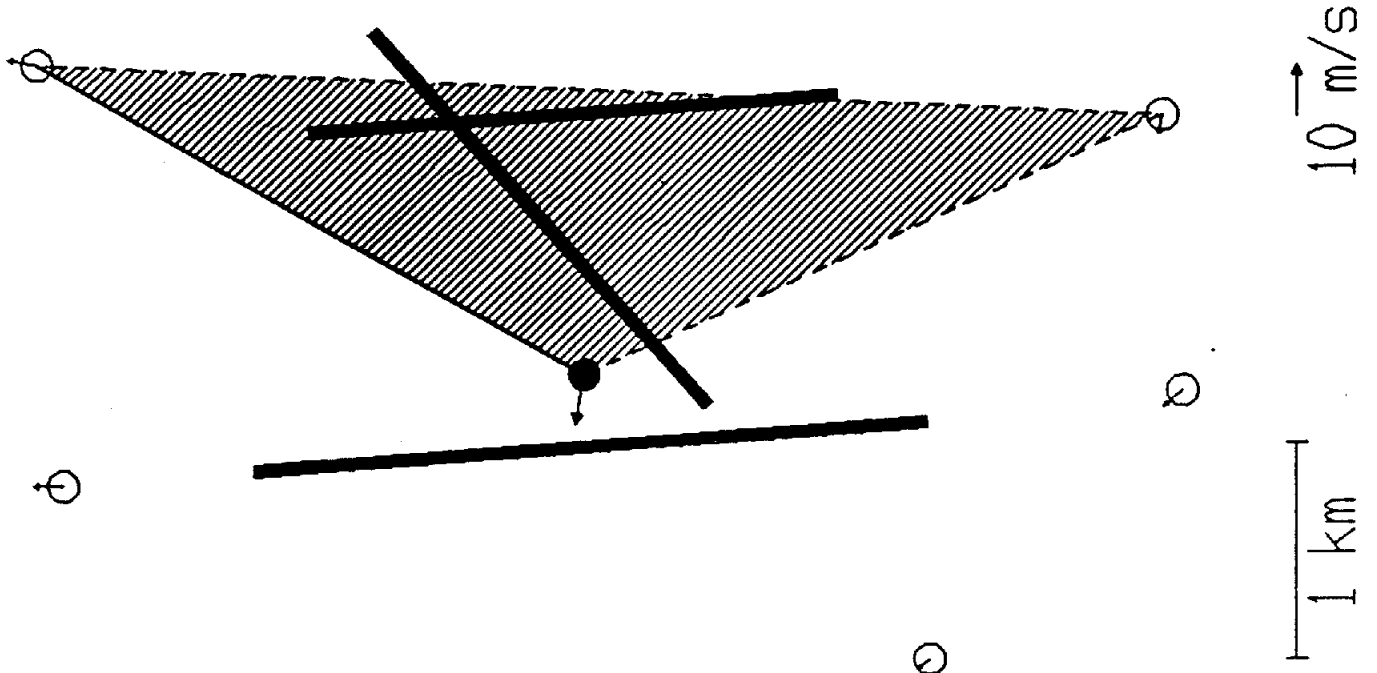

- STATION
- STATION ALARM
- EDGE ALARM
- ▨ TRIANGLE ALARM
- ↑ WIND VECTOR
- RUNWAY



13

FAA TECHNICAL CENTER
7/7/94

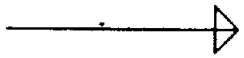
CHARLOTTE INTL AIRPORT
DATE: 7/ 2/94
TIME: 22:41:17

- STATION ○
- STATION ALARM ●
- EDGE ALARM ———
- TRIANGLE ALARM 
- WIND VECTOR 
- RUNWAY 

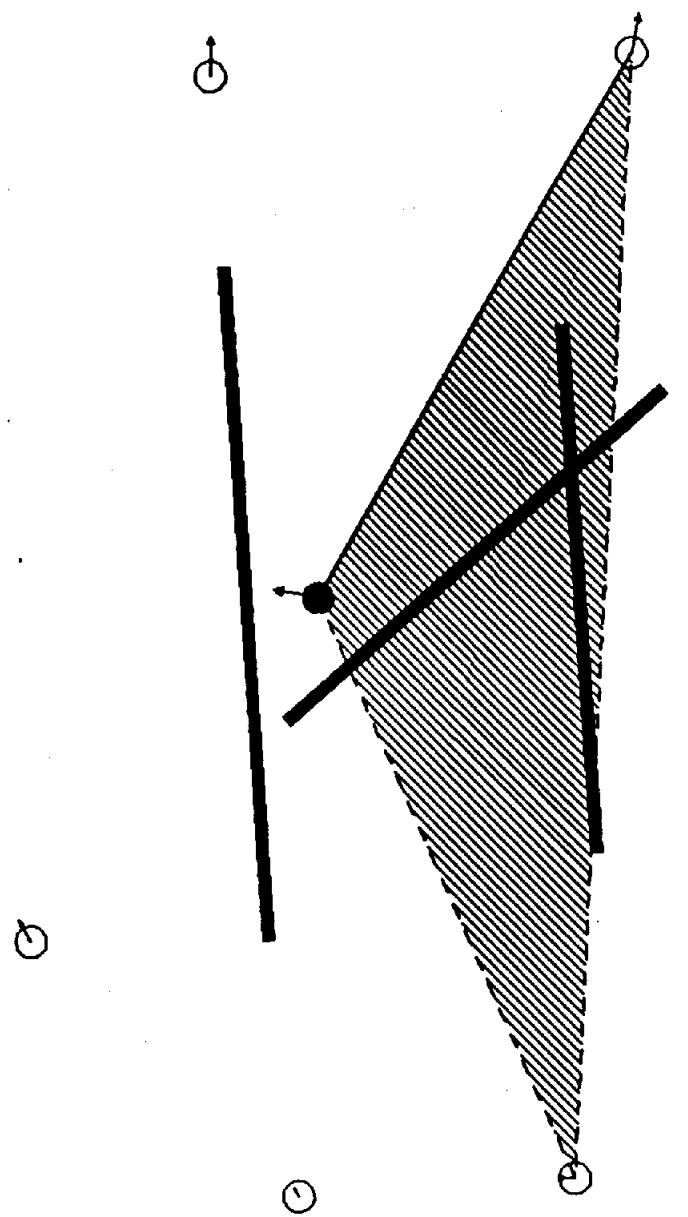



1 km

10 m/s

FAA TECHNICAL CENTER
7/7/94

14

CHARLOTTE INTL AIRPORT
DATE: 7/ 2/94
TIME: 22:41:27

- STATION ○
- STATION ALARM ●
- EDGE ALARM ———
- TRIANGLE ALARM 
- WIND VECTOR 
- RUNWAY 

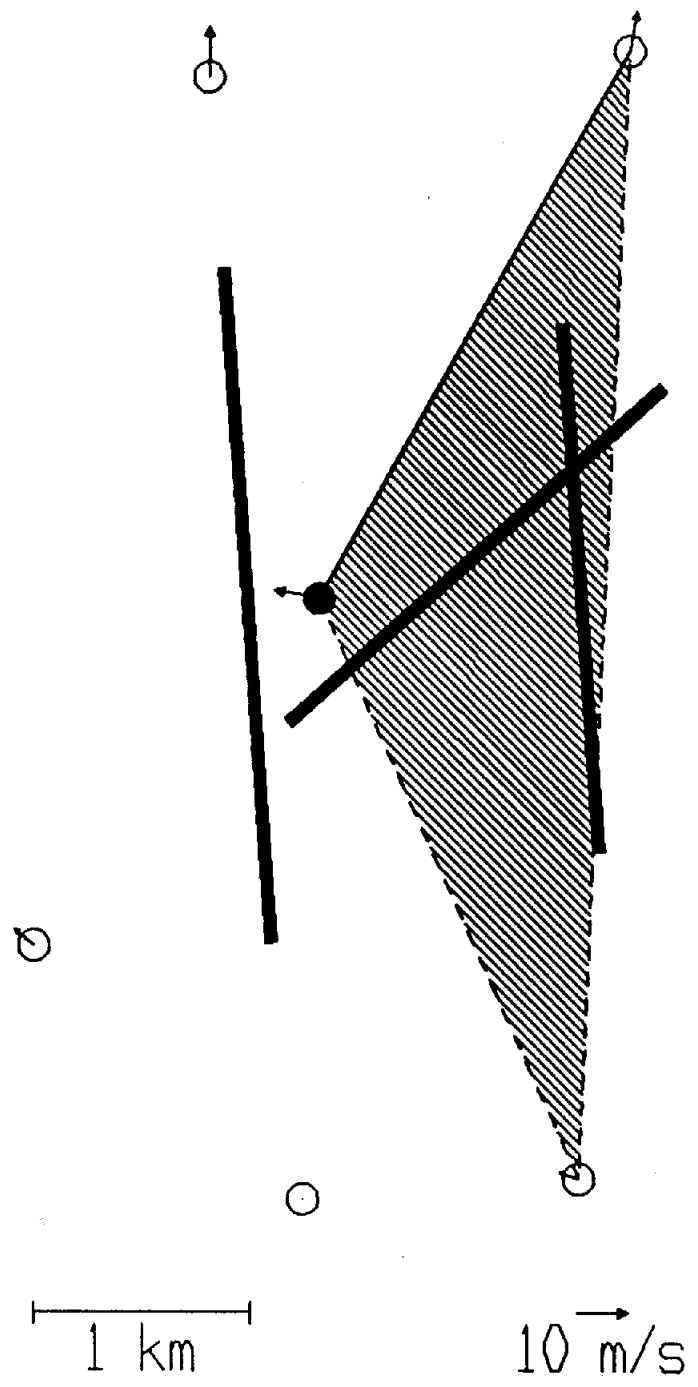

FAA TECHNICAL CENTER
7/7/94

15

CHARLOTTE INTL AIRPORT
DATE: 7/ 2/94
TIME: 22:41:37

- STATION
- STATION ALARM
- EDGE ALARM
- ▴ TRIANGLE ALARM
- WIND VECTOR
- ▬ RUNWAY

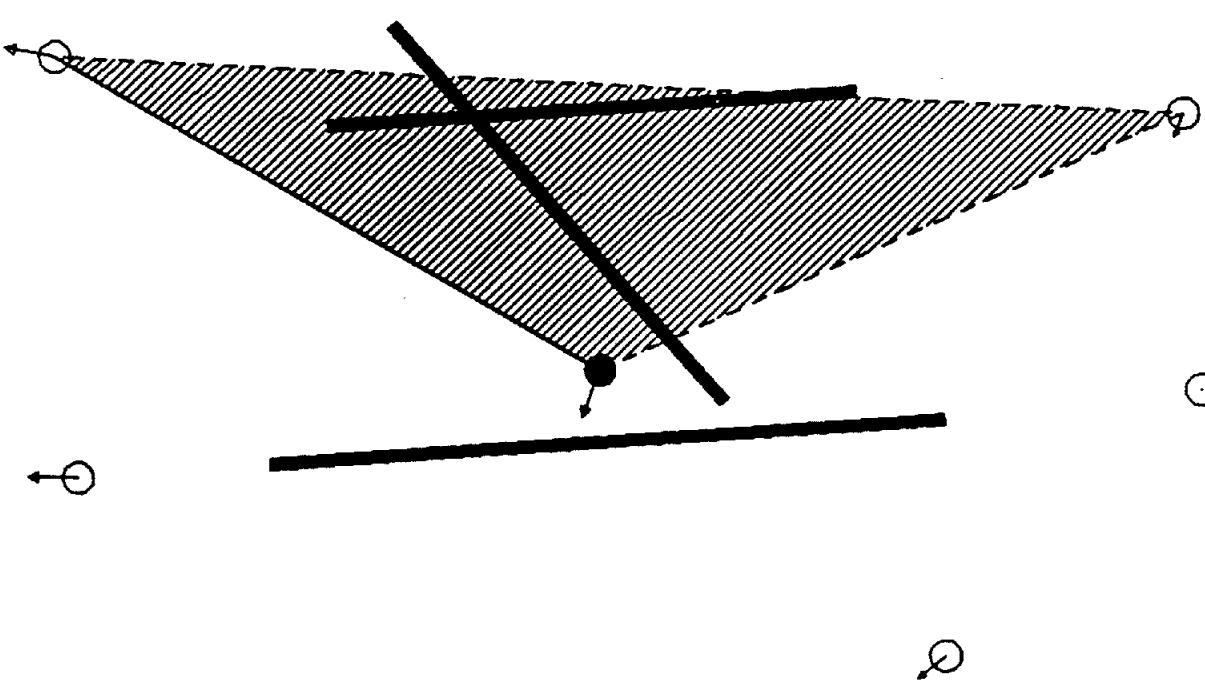

FAA TECHNICAL CENTER
7/7/94

16

CHARLOTTE INTL AIRPORT

DATE: 7/ 2/94

TIME: 22:41:47

STATION



STATION ALARM



EDGE ALARM



TRIANGLE ALARM



WIND VECTOR



RUNWAY

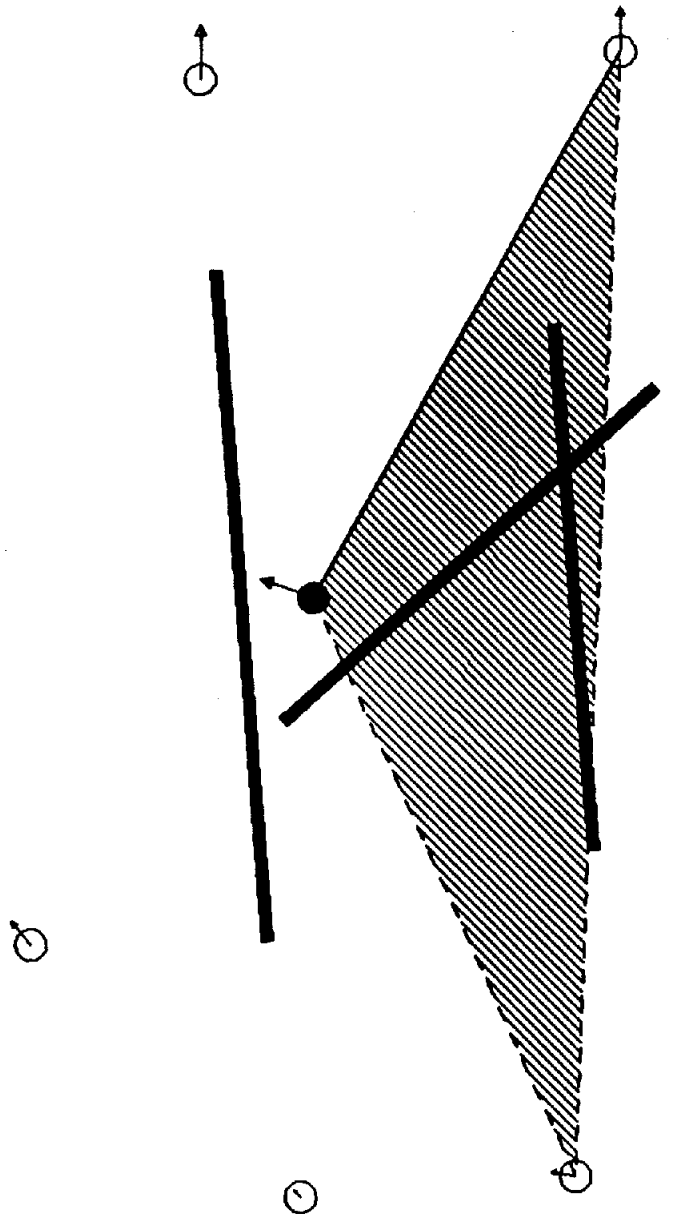

1 km

10 m/s

FAA TECHNICAL CENTER
7/7/94

17

CHARLOTTE INTL AIRPORT

DATE: 7/ 2/94

TIME: 22:41:57

STATION



STATION ALARM



EDGE ALARM



TRIANGLE ALARM



WIND VECTOR

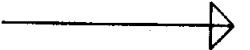

RUNWAY

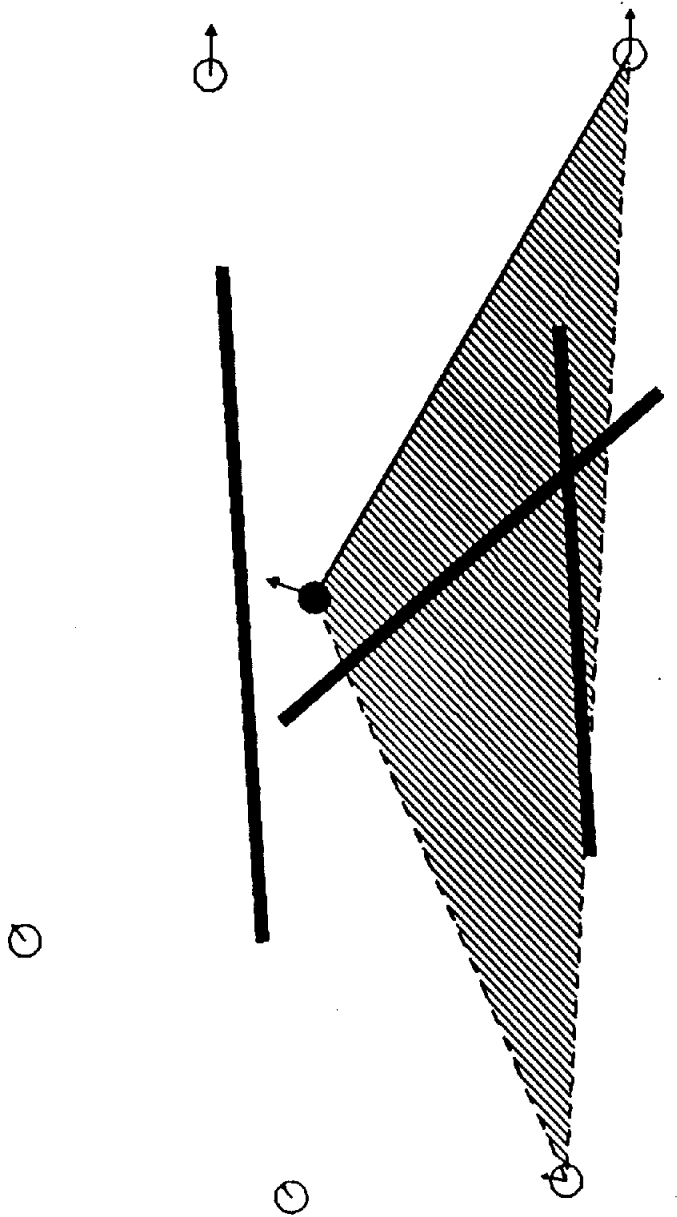

1 km

10 m/s

FAA TECHNICAL CENTER
7/7/94

18

CHARLOTTE INTL AIRPORT

DATE: 7/ 2/94

TIME: 22:42: 7

STATION



STATION ALARM



EDGE ALARM



TRIANGLE ALARM



WIND VECTOR



RUNWAY

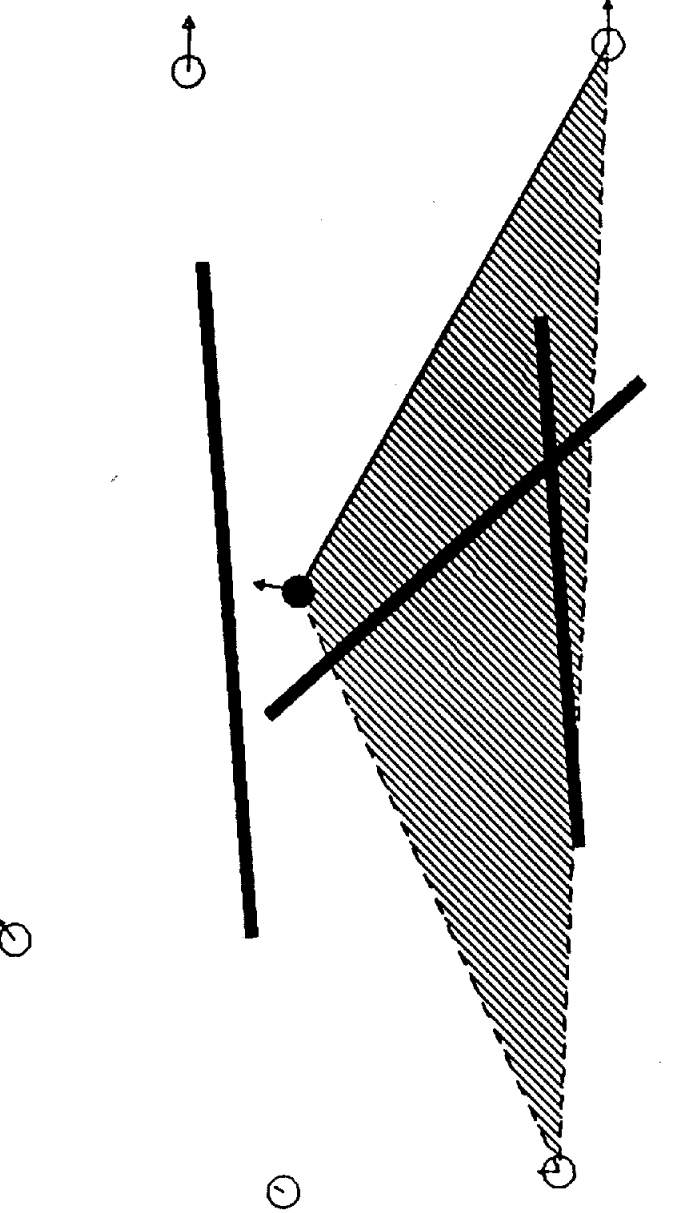



1 km

10 m/s

FAA TECHNICAL CENTER
7/7/94

19

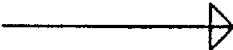
CHARLOTTE INTL AIRPORT
DATE: 7/ 2/94
TIME: 22:42:17

- STATION ○
- STATION ALARM ●
- EDGE ALARM ———
- TRIANGLE ALARM 
- WIND VECTOR 
- RUNWAY 

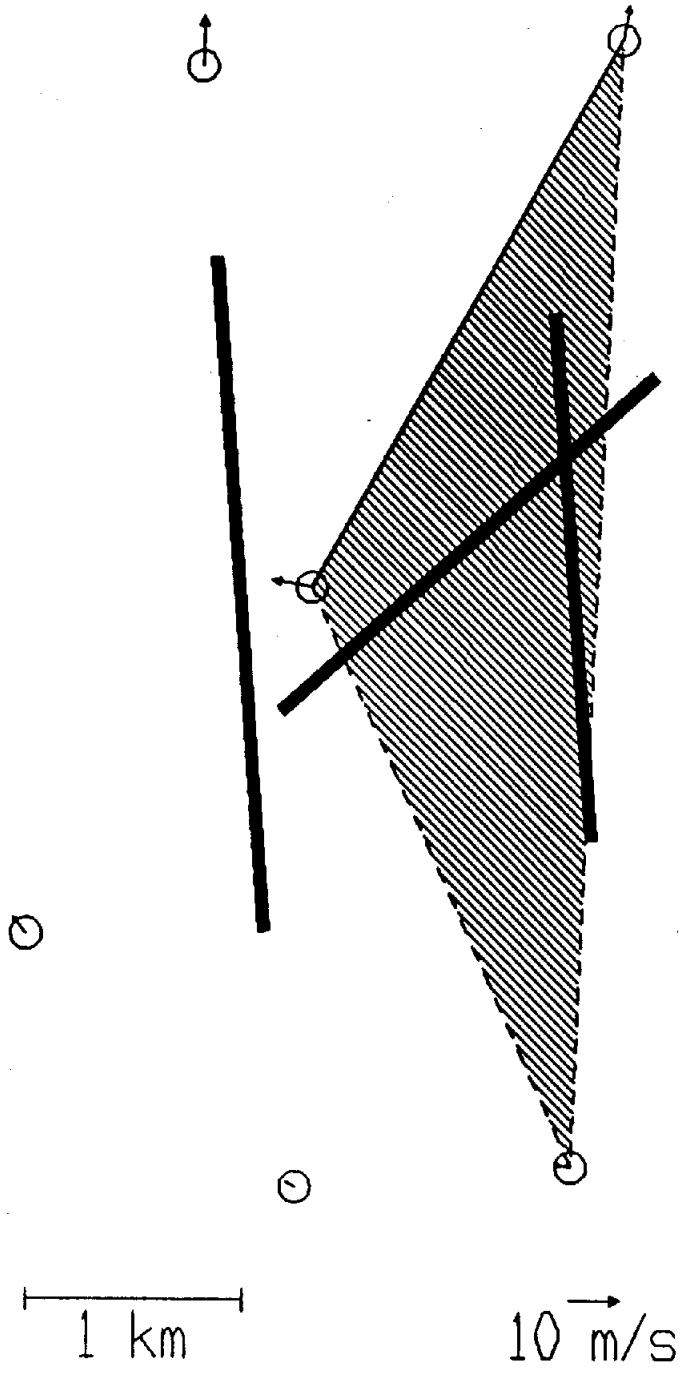



FAA TECHNICAL CENTER
7/7/94

20

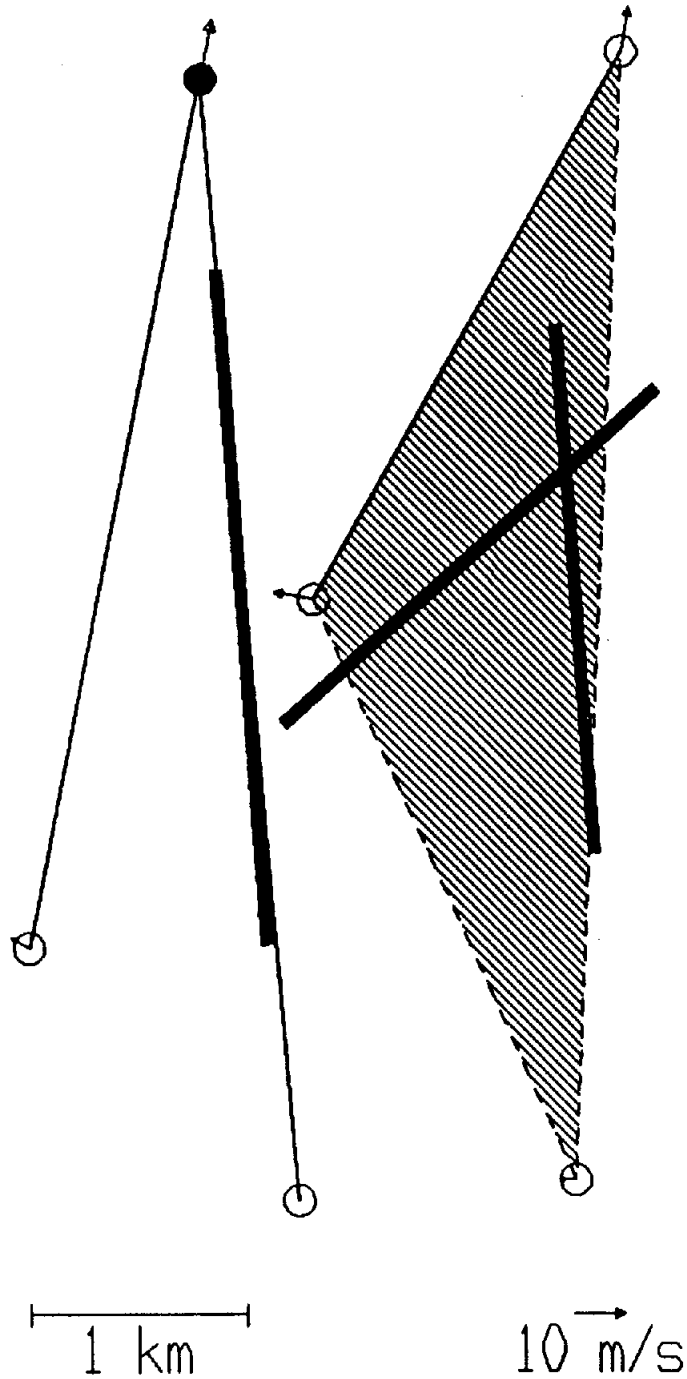
CHARLOTTE INTL AIRPORT
DATE: 7/ 2/94
TIME: 22:42:27

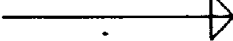





- STATION ○
- STATION ALARM ●
- EDGE ALARM ———
- TRIANGLE ALARM 
- WIND VECTOR 
- RUNWAY 

FAA TECHNICAL CENTER
7/7/94

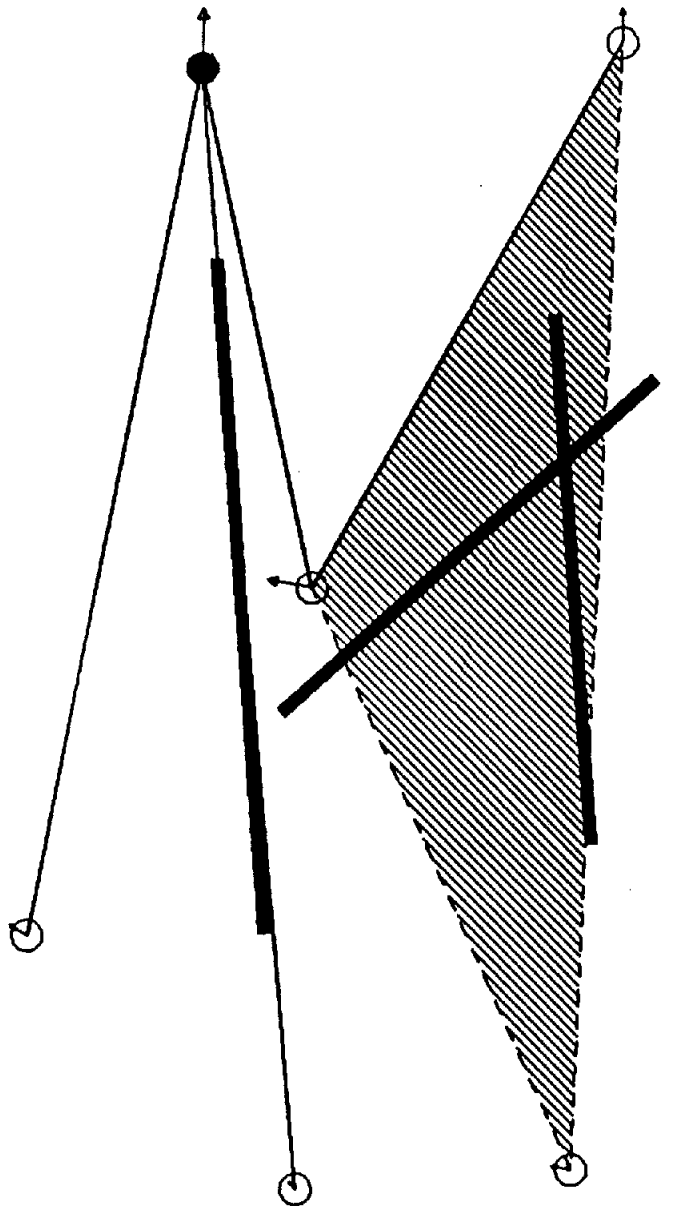
21

CHARLOTTE INTL AIRPORT
DATE: 7/ 2/94
TIME: 22:42:37

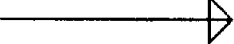

- STATION ○
- STATION ALARM ●
- EDGE ALARM ———
- TRIANGLE ALARM 
- WIND VECTOR 
- RUNWAY 

1 km

10 m/s

FAA TECHNICAL CENTER
7/7/94

22

CHARLOTTE INTL AIRPORT

DATE: 7/ 2/94

TIME: 22:42:47

STATION



STATION ALARM



EDGE ALARM



TRIANGLE ALARM



WIND VECTOR



RUNWAY

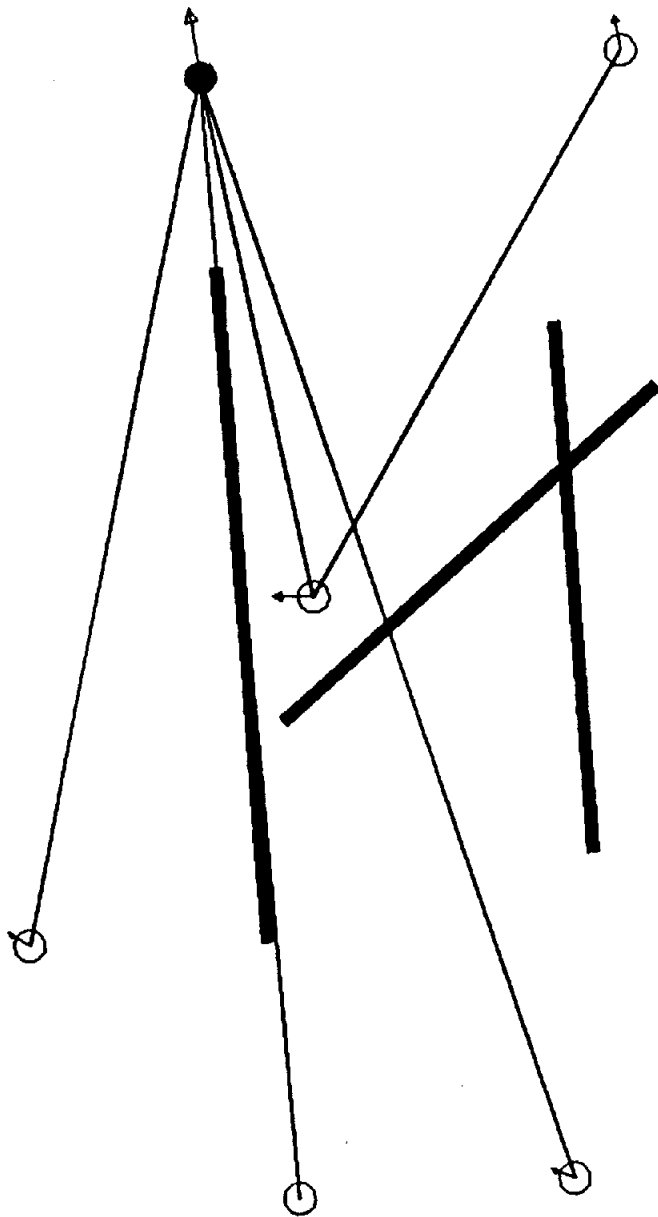



1 km

10 m/s

FAA TECHNICAL CENTER
7/7/94

23

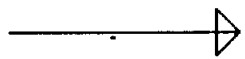
CHARLOTTE INTL AIRPORT
DATE: 7/ 2/94
TIME: 22:42:57

- STATION ○
- STATION ALARM ●
- EDGE ALARM —————
- TRIANGLE ALARM 
- WIND VECTOR 
- RUNWAY 

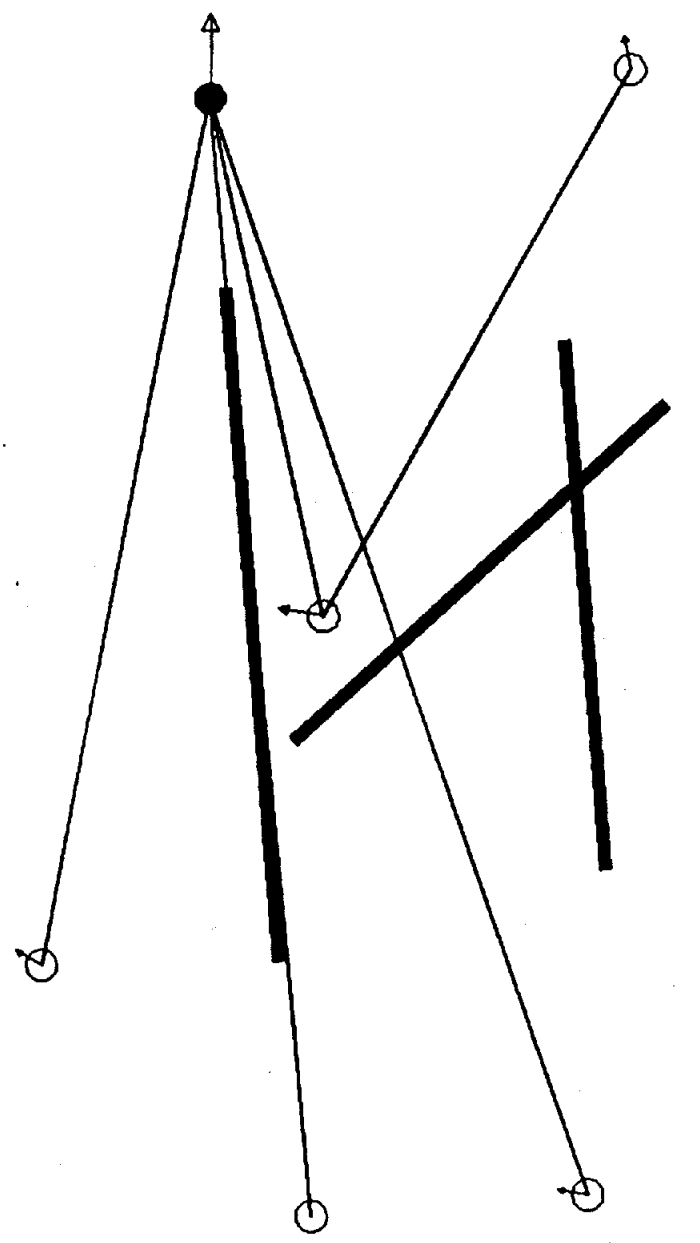

1 km



10  m/s

FAA TECHNICAL CENTER
7/7/94

24

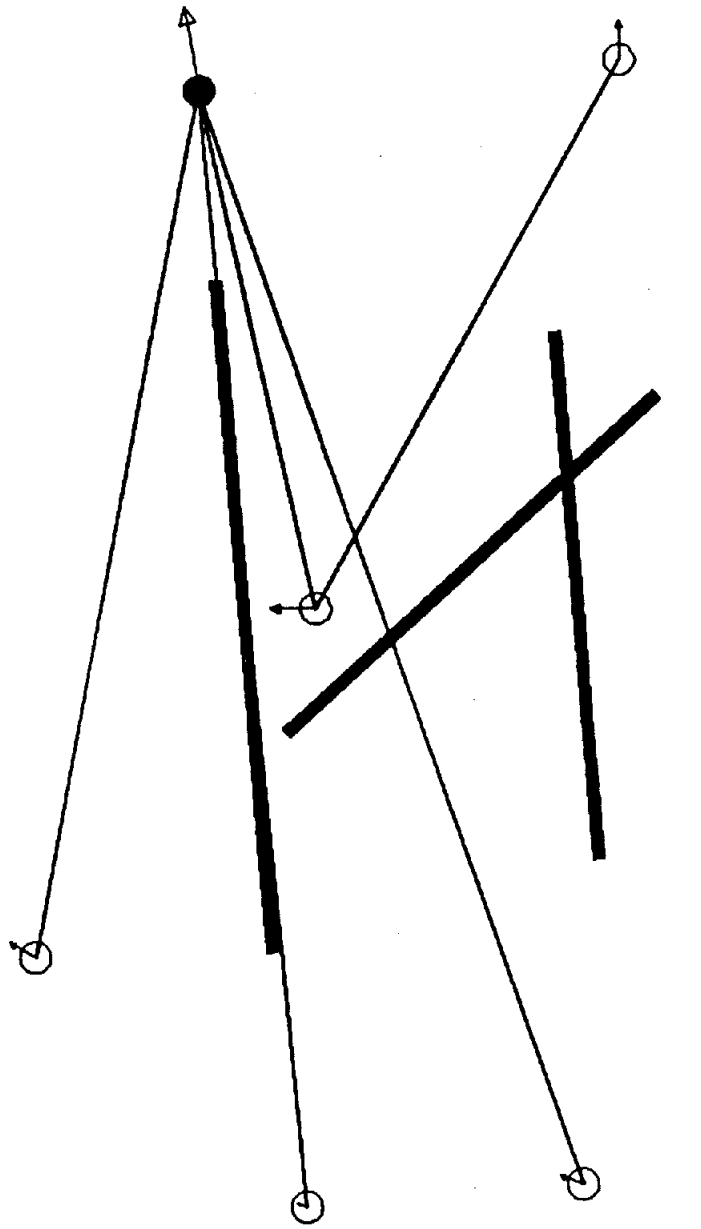
CHARLOTTE INTL AIRPORT
DATE: 7/ 2/94
TIME: 22:43: 7

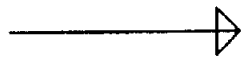

- STATION ○
- STATION ALARM ●
- EDGE ALARM —————
- TRIANGLE ALARM 
- WIND VECTOR 
- RUNWAY 

1 km

10 m/s

FMA TECHNICAL CENTER
7/7/94

25