

# NATIONAL TRANSPORTATION SAFETY BOARD

Office of Research and Engineering  
Materials Laboratory Division  
Washington, D.C. 20594



June 6, 2008

MATERIALS LABORATORY FACTUAL REPORT

Report No. 08-049

## A. ACCIDENT

Place : St. Louis, Missouri  
Date : September 28, 2007  
Vehicle : Boeing MD-82, N454AA  
Operator : American Airlines, Flight 1400  
NTSB No. : DCA07MA310  
Investigator : Harald Reichel, AS-40

## B. COMPONENTS EXAMINED

Air Filter P/N 11-10579  
Seven Exemplar Air Filters

## C. DETAILS OF THE EXAMINATION

The received pieces of the accident air filter assembly are displayed in figure 1. These consisted of the filter housing, the threaded fitting with metal O-ring for the filter element assembly, and the filter element end cap. As shown in figure 2, a portion of the filter cloth was found lodged inside the bore of the housing. The outer surface of the housing was marked with "PTI, Part No. 11-10579, S/N 6628, 75, PN Filter, DAC, 7958540-1, DC-A". The upper end of the filter element end cap was marked "PTI, Lot No. 00??<sup>1</sup> 21-10930".

The exterior of the filter assembly showed darkening of the surface consistent with heat tinting from high temperature exposure. The cadmium plating on the washer between the fitting and the body was bubbled indicating temperatures near the melting point of cadmium, 610 °F.

The portion of the filter cloth found inside the housing was folded and tightly compressed and partially imbedded into the internal threads of the housing. Figure 3 (a) and (c) depict the approximate location and condition of the cloth (shown after sectioning of the housing). Figure 3 (d) shows a piece of the removed cloth. The received portion of the filter cloth represented about ¼ to ½ inch of the filter element length. The filter cloth is

---

<sup>1</sup> ?? denotes illegible but present characters.

part of the brazed (inseparable) filter element assembly p/n 21-10930, along with the threaded fitting and filter end cap as illustrated in figure 3 (b).

According to the manufacturer, PTI, the filter cloth is a pleated cylindrical filter media constructed in two layers, a fine outer screen and a coarser inner screen. The open ends of the pleated filter cloth assembly are then brazed to the end cap and the threaded fitting.

The filter element assembly had major separations through the cloth adjacent to the braze joints at the fitting and the end cap. The braze metal and small portions of the cloth remained attached to the fitting (figure 4) and cap (figure 5). Magnified examinations found severe rubbing damage at the separations, as shown in figure 4 (c) and (d) and figure 5. The damage completely obliterated any fracture features at the separations. Similarly, mechanical damage obliterated separation features on the portion of cloth removed from the housing. The damage was consistent with small amplitude rubbing between opposed side of the separations and not from foreign objects.

The filter end cap was also mechanically damaged as shown in figure 5. The outer diameter edge of the cap was rubbed and rounded as indicated by blue lines in figure 5 (b). Comparisons to exemplar end caps found the accident cap was reduced in diameter by as much as 0.020 inch. The cap's pilot diameter, see figure 5 (b), was also rubbed and rounded with a similar mating pattern found on the pilot diameter of the fitting, normally at the opposite end of the filter.

The filter housing was longitudinally sectioned to display the interior surface as shown in figure 6. The central region of the cylindrical interior surface (between yellow lines in (a)) was burnished and polished smooth, obliterating the original turned surface finish. The original machined finish only remained in small bands at the upper (b) and lower (c) end of the section. The interior of an exemplar housing is shown in figure 6 (d) with an enlargement of the surface for comparison.

The damage to the interior of the housing, the end cap and the filter cloth was consistent with vibratory motion of the filter cloth and end cap within the housing. Contact between the end cap and housing mutually burnished the surfaces. The extent of polishing of the housing indicated that the end cap progressed downward in the housing, eventually contacting the fitting end.

## Exemplars

Seven exemplar air filters assemblies, p/n 21-10930, were received from American Airlines for examinations. One filter, marked as lot 030, was separated through the element and had been removed from an engine received for overhaul. The separated filter, shown in figure 7, was received with the filter housing. The housing was marked with p/n 11-10579 and s/n 6911. The remaining six filters were removed from in-service aircraft and were received without the housings. According to PTI, filters with 3 digit lot numbers were manufactured by preceding companies (PTI Purolator or HR Textron) and manufacturing dates are not known. PTI instituted 4 digit lot numbers in 1991 and the dates of manufacture are shown in the table. Other known information for each is presented in the table below.

A/C	Eng	Date Removed	Filter Lot	Manufacture Date	Notes
UNK	UNK	UNK	030	Prior to 1991	Fractured at lower braze line. Engine overhaul. Housing included S/N 6911 PTI Purolator
N4UC	#2	4/28/08	012	Prior to 1991	Linear crack along one pleat HR symbol. Cracked at top and bottom.
UNK	UNK	UNK	125	Prior to 1991	Cracks along bottom above the braze line. HRT symbol.
N457	#1	4/23/08	0067	5-1-01	Cracks along bottom above the braze line. PTI symbol.
N578	#1	5/2/08	0072	1-21-02	No Cracks noted PTI symbol
N481	#2	5/5/08	066	Prior to 1991	No Cracks noted PTI Purolator
N4XA	#1	5/9/08	078	Prior to 1991	No Cracks noted PTI Purolator

The separated filter was transversely fractured through the filter cloth just above the lower braze joint to the threaded fitting, as shown in figures 7 and 8 (a). With the housing longitudinally sectioned, a burnished ring was apparent on the interior surface corresponding to the approximate installed location of the filter end cap. The polished ring is shown in figure 7 (c) between the yellow lines. The outer diameter of the end cap was also burnished as shown in figure 7 (b), removing the original machined finish.

Optical examinations of the separated filter revealed that the longitudinal wires of the cloth screens were fractured near the edge of the braze joint. Close examinations found that the wire fracture surfaces and surrounding areas were rubbed and mechanically damaged to the point that no original fractures remained, see figures 8 (b) and (c).

The remaining six filters were received intact. Magnified optical inspections of the six filters revealed three filters with fractured wires in the outer screens. The fractured

wires were in general only visible at magnifications of 30X and above. Typical areas of the cracked filters are displayed in figures 9, 10 and 11. Filters from lots 0067 and 125 had transverse cracks near the lower braze, as shown in figures 9 and 10. While the filter from lot 012 showed transverse cracks near the upper and lower braze lines and longitudinal cracks along the pleats at the upper braze, as shown in figure 11.

The fine outer screen was partially removed from the filters from lot 012 and 0067 in the area of the cracks. No cracks were found in the underlying coarse screen wires of the lot 012 filter but multiple cracked were visible in the longitudinal wires of the coarse screen of 0067, as shown in figure 12.

SEM examinations of the fractured fine wires revealed oxidation and mechanical damage to the majority of the wire fracture faces that obliterated most of the separation features. The wire fractures appeared brittle in nature in that there was no apparent yielding or necking adjacent to the breaks. A typical damaged fracture is displayed in figure 13 (a). A few wire fractures were undamaged. These fracture contained micro features indicative of fatigue propagation with initiation at the contact point of the crossing wires. A typical undamaged fracture is displayed in figure 13 (b) with the initiation area and direction of propagation denoted. Intact wires that were fractured during removal of the fine screen displayed significant necking and a dimpled fractured face.

The end cap of the filter from lot 0067 had polishing of the outer diameter. The end caps of the other two filters displayed typical machining marks with no polishing. No housings were received to inspect for comparable burnishing rings.

Joe Epperson  
Senior Metallurgist

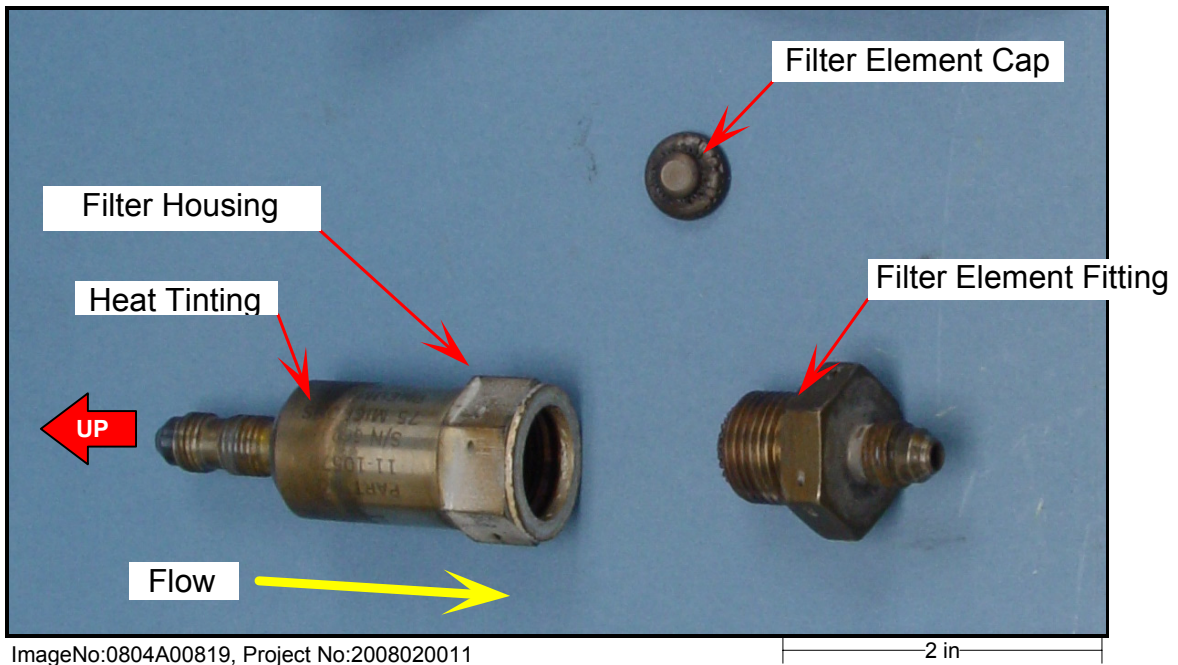
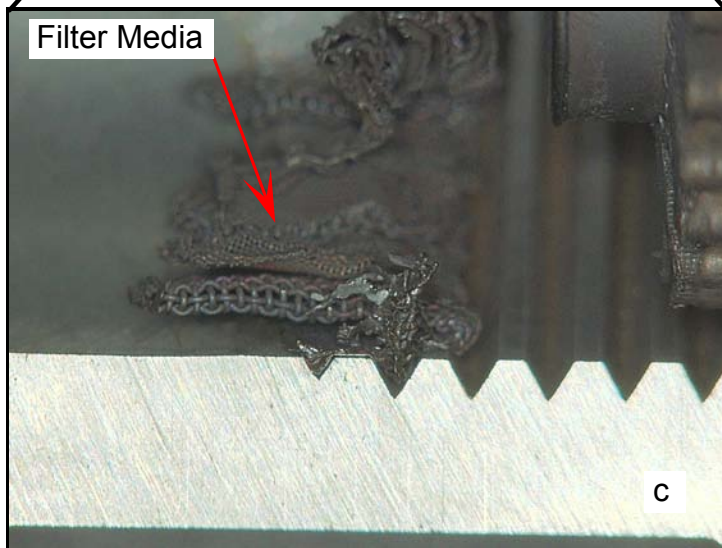
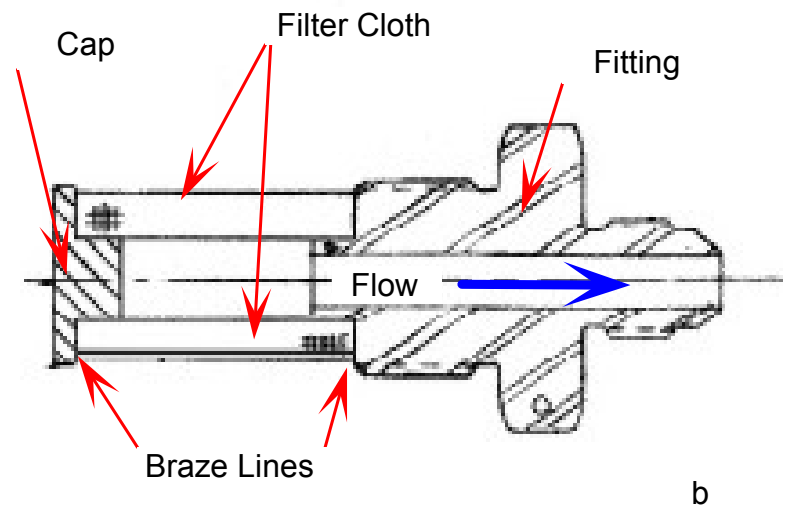
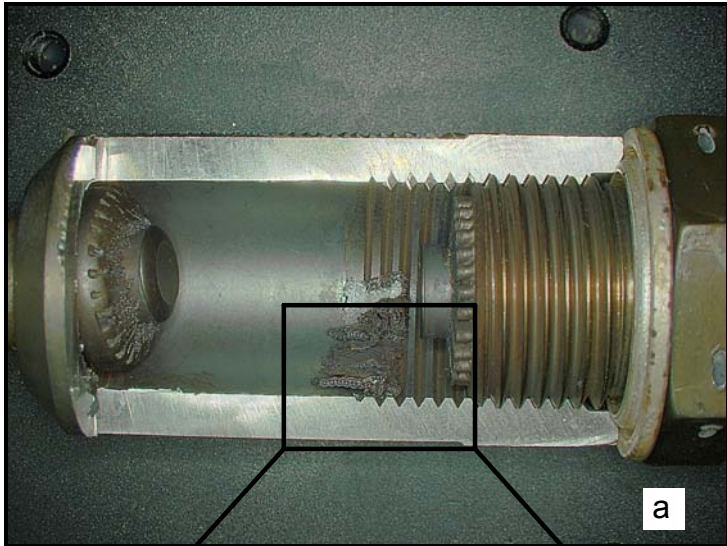

Figure 1--The as recieved air filter components. Heat tinting is noticable on the upper end of the filter housing.



Figure 2--A view inside the filter housing at the remaining filter cloth material.



ImageNo: 0804A00729, Project No:2008020011

200 mils

Figure 3--View of the components installed in the sectioned housing (a) with a closer view of some of the filter material positioned as found in the threads (c). Illustration of the fitting assembly components (b). A closer view of the filter material showing the outline of the housing threads (d).



ImageNo:0804A00728, Project No:2008020011

200 mils

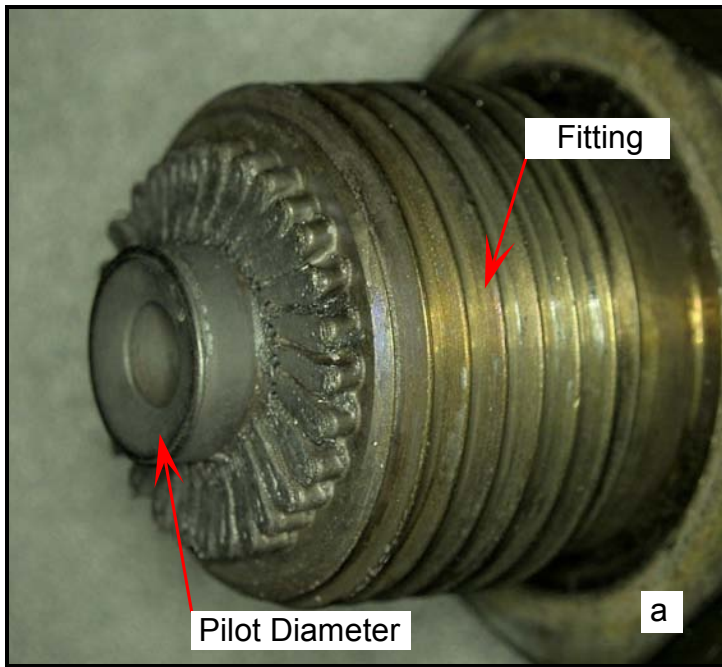

ImageNo:0804A00617, Project No:2008020011

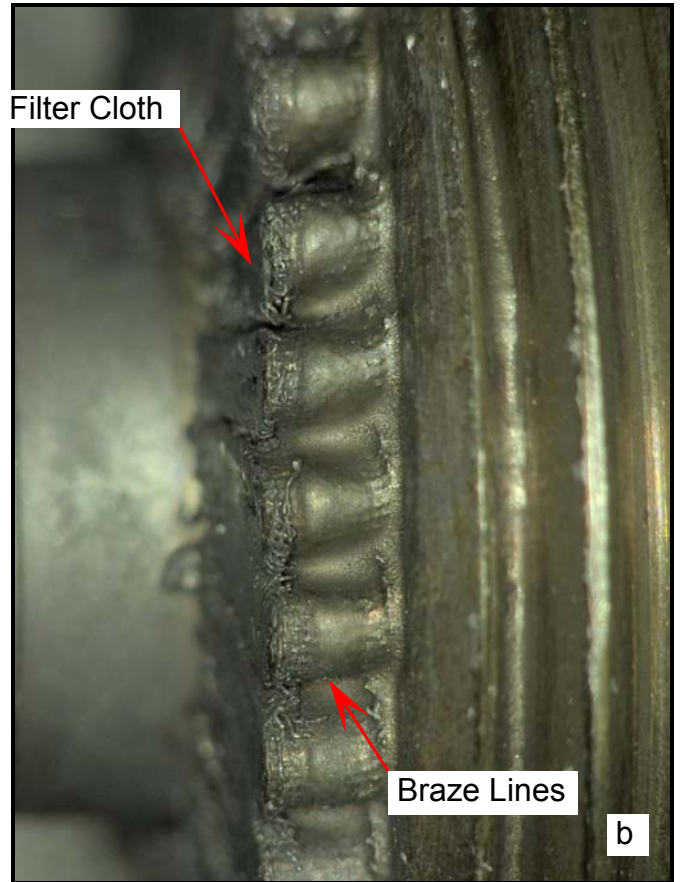

ImageNo: 0804A00625, Project No:2008020011

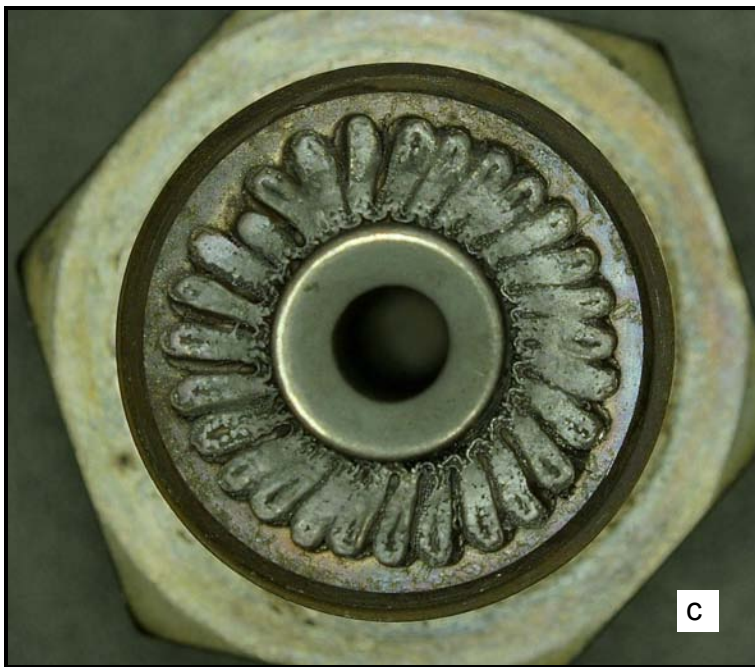

ImageNo:0804A00617, Project No:2008020011



ImageNo: 0804A00625, Project No:2008020011

Figure 4--The as-received fitting end at the separation of the filter adjacent to the braze joint (a) and (b). Closer views of the face separation showing extensive mechanical damage that obliterated fracture features.

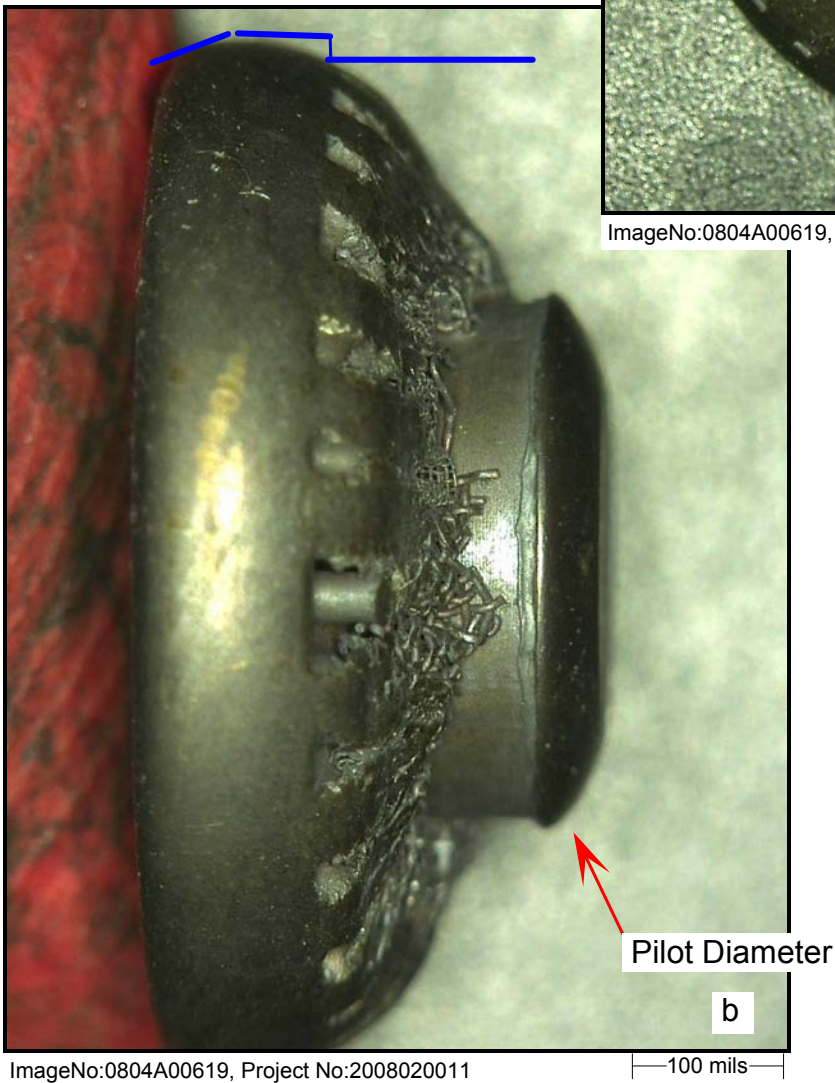
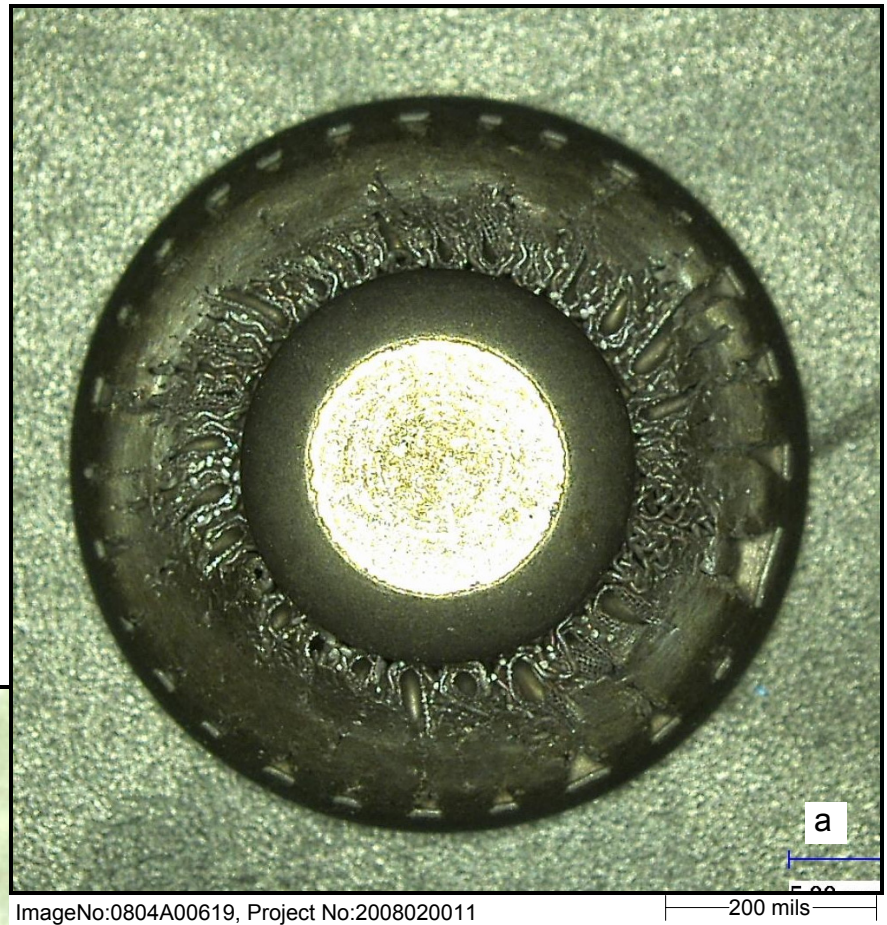

Figure 5--The filter element end cap showing the deformation and burnishing damage to the outer diameter and pilot diameter. The approximate original cap profile is indicated by blue lines in (b)



Figure 6--The sectioned housing showing burnishing features between yellow lines on the interior (a). The upper and lower extents are shown in (b) and (c). The interior of an exemplar is shown in (d) for comparison.



100 mils

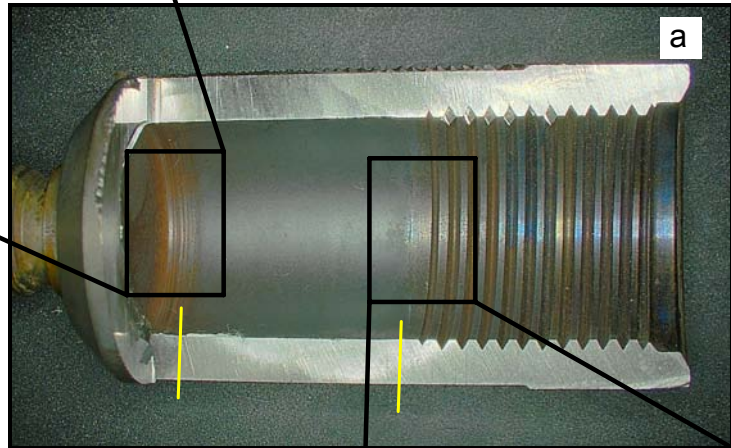

500 mils

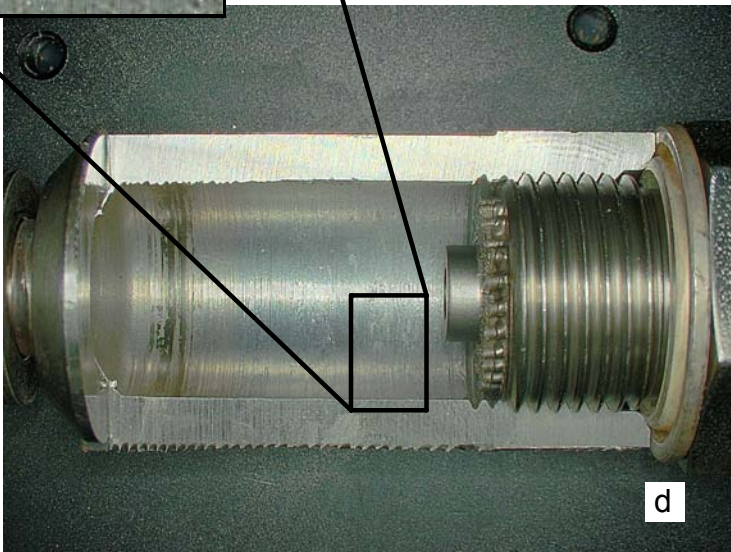

d

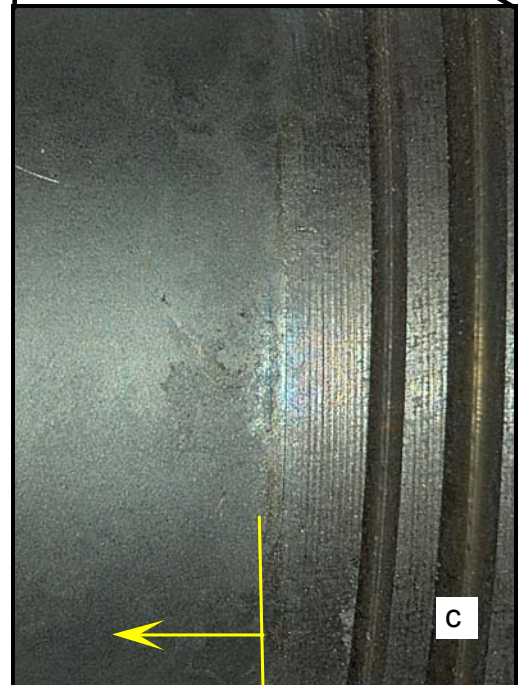

100 mils

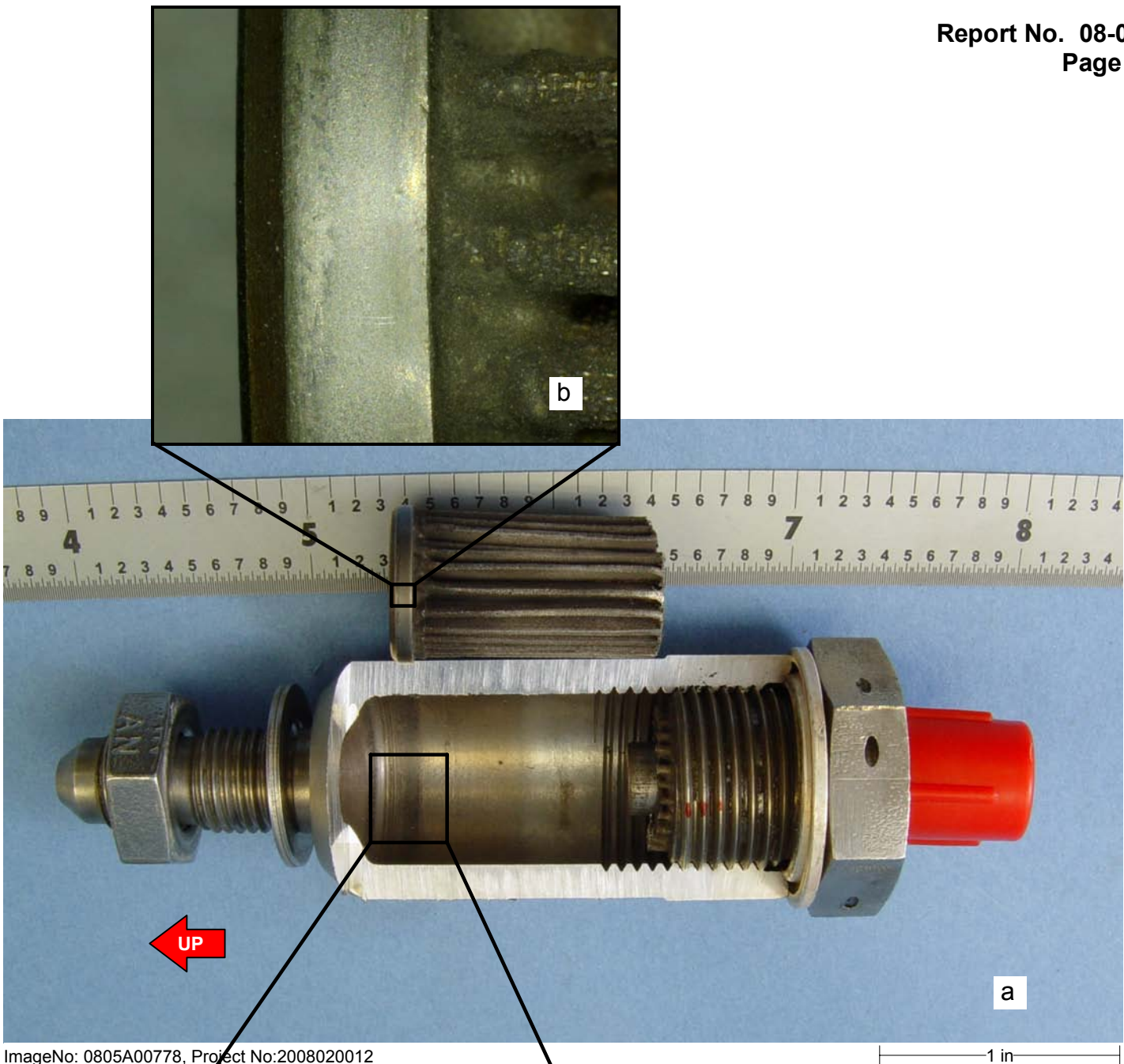

ImageNo: 0805A00778, Project No:2008020012

1 in

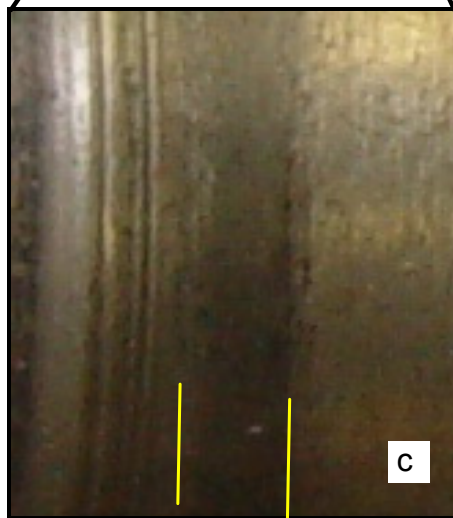

100 mils

Figure 7--Air filter components of s/n 6911 with the housing sectioned (a). (b) shows burnishing on the outer diameter of the end cap and the mating area (between yellow lines) on the housing interior (c).

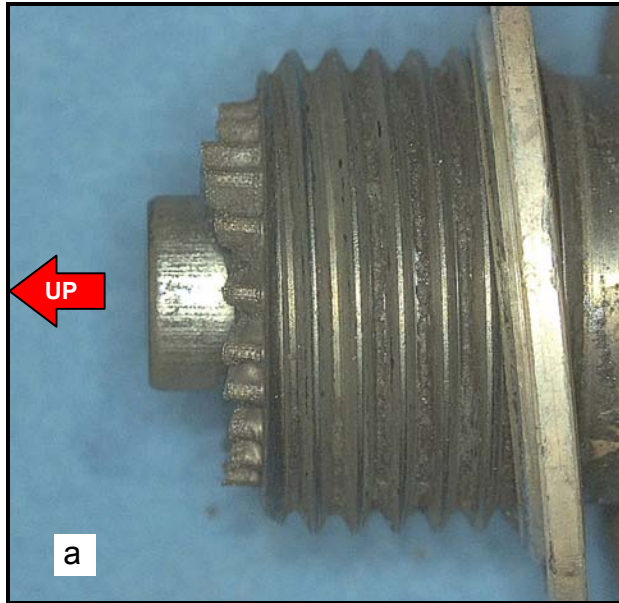

ImageNo:0805A00737, Project No:2008020011

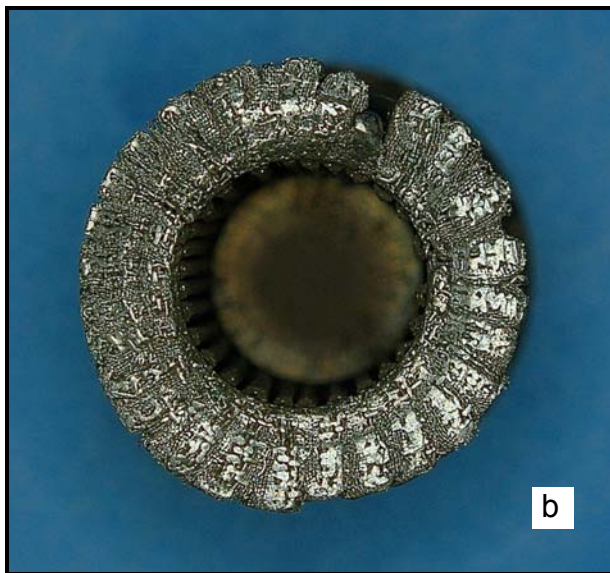

ImageNo: 0805A00735, Project No:2008020011

Figure 8--The separated filter element (a) with extensive mechanical damage of the faces (b) and (c).

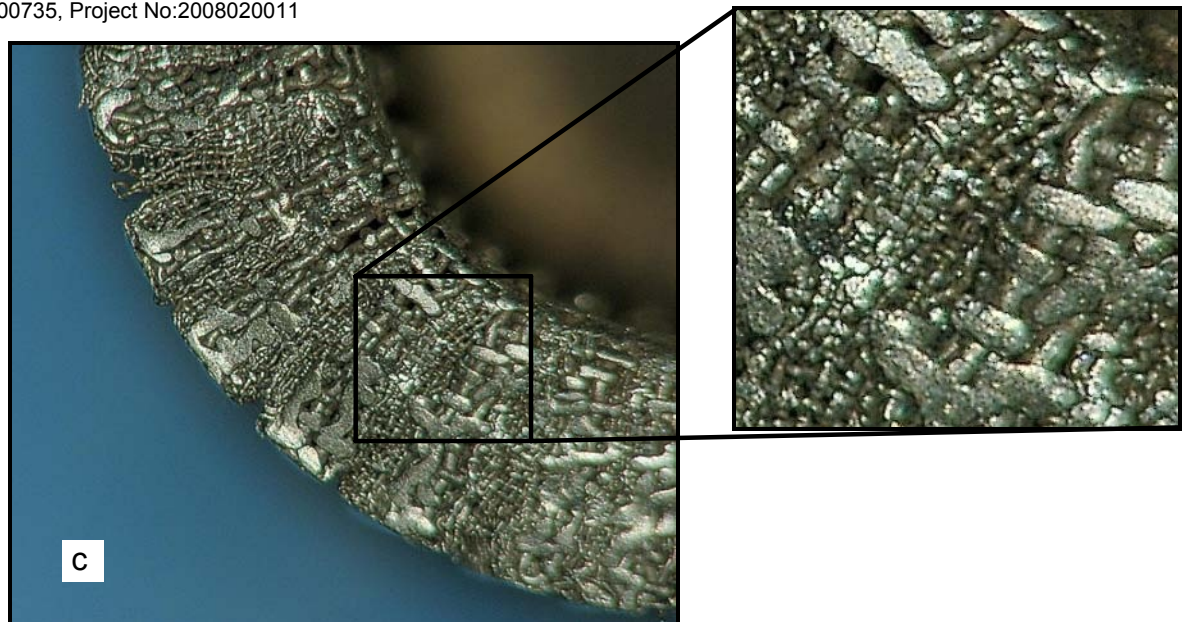

ImageNo:0805A00737, Project No:2008020011



ImageNo:0805A00621, Project No:2008020012

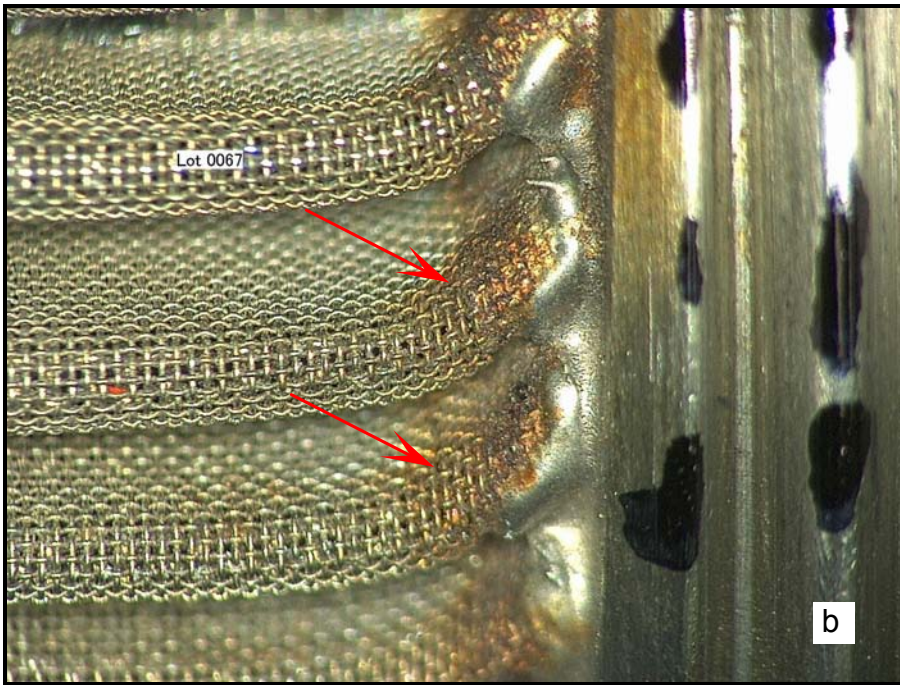
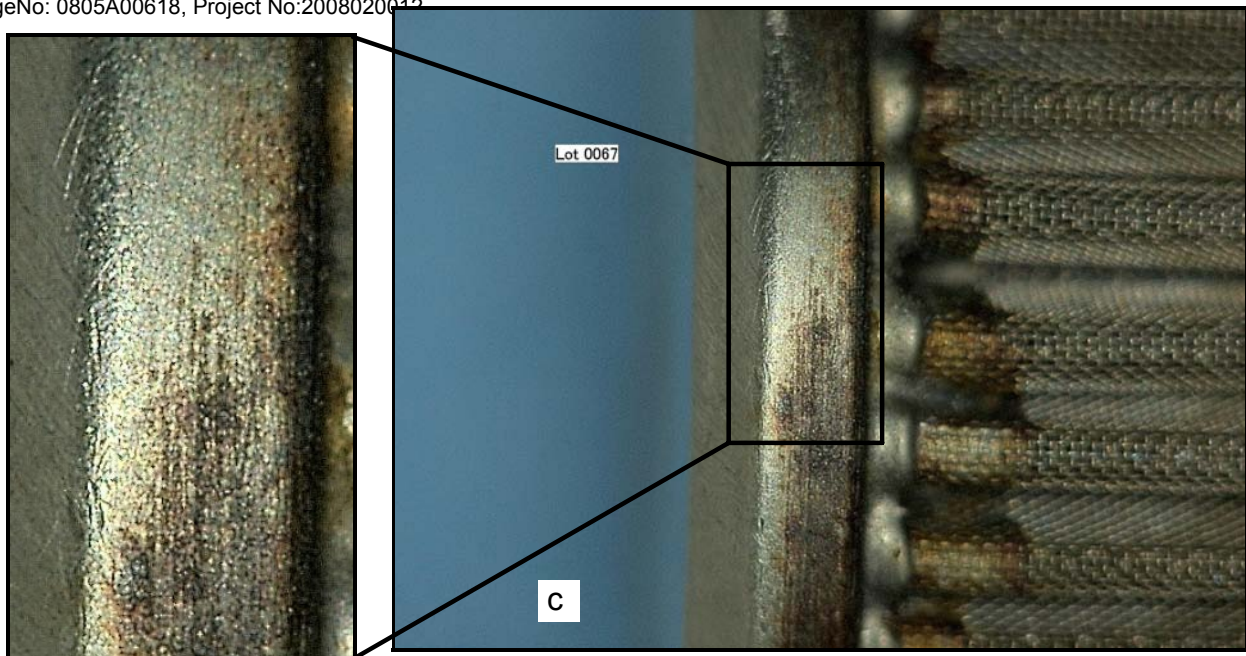

Figure 9--Exemplar from lot 0067 (a) with arrows denoting locations of cracked fine screen (b). Burnishing of the cap diameter shown in (c) and enlargement.

ImageNo: 0805A00618, Project No:2008020012



ImageNo:0805A00621, Project No:2008020012



ImageNo:0805A00627, Project No:2008020012

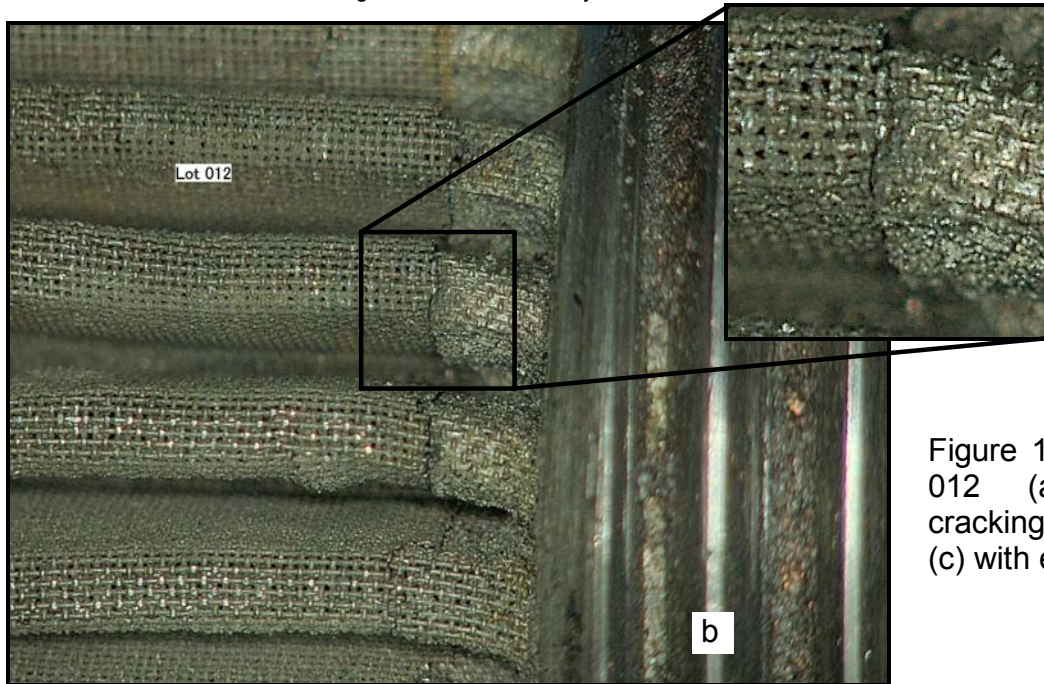
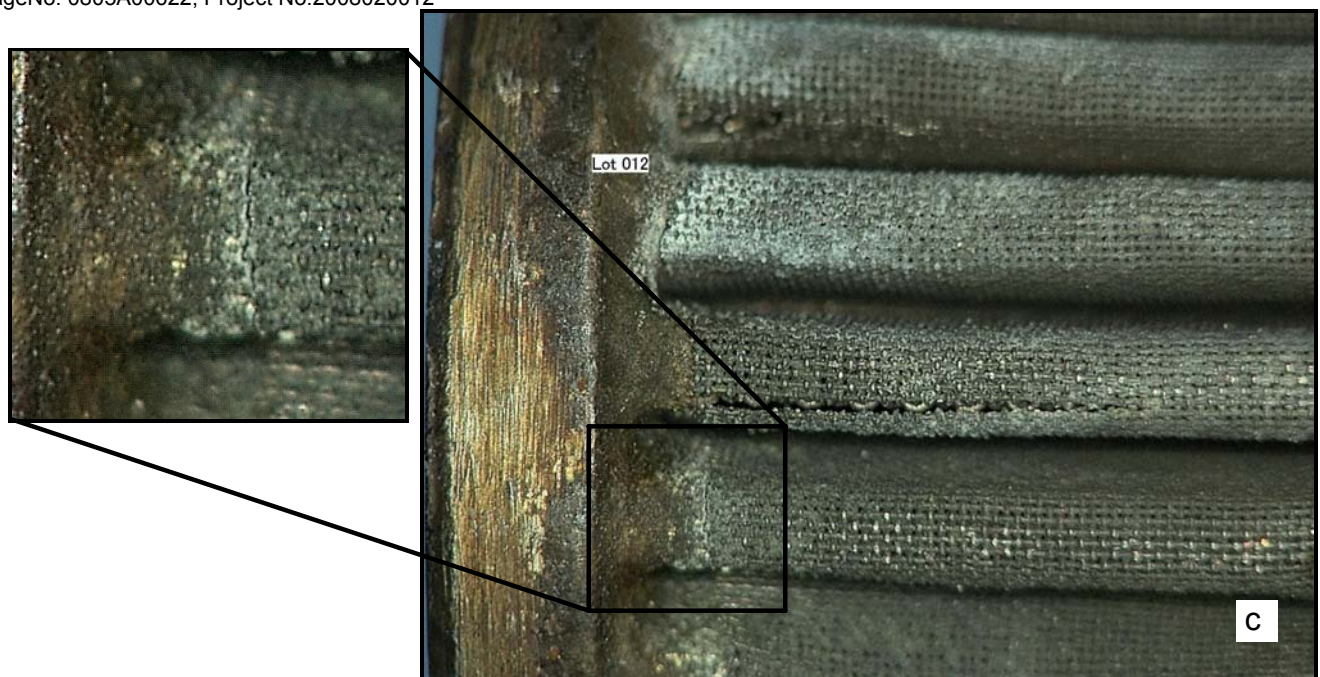

Figure 10--Filter element from lot 012 (a) showing extensive cracking of the fine screen (b) and (c) with enlarged areas.

ImageNo: 0805A00622, Project No:2008020012



ImageNo:0805A00627, Project No:2008020012



ImageNo:0805A00636, Project No:2008020012

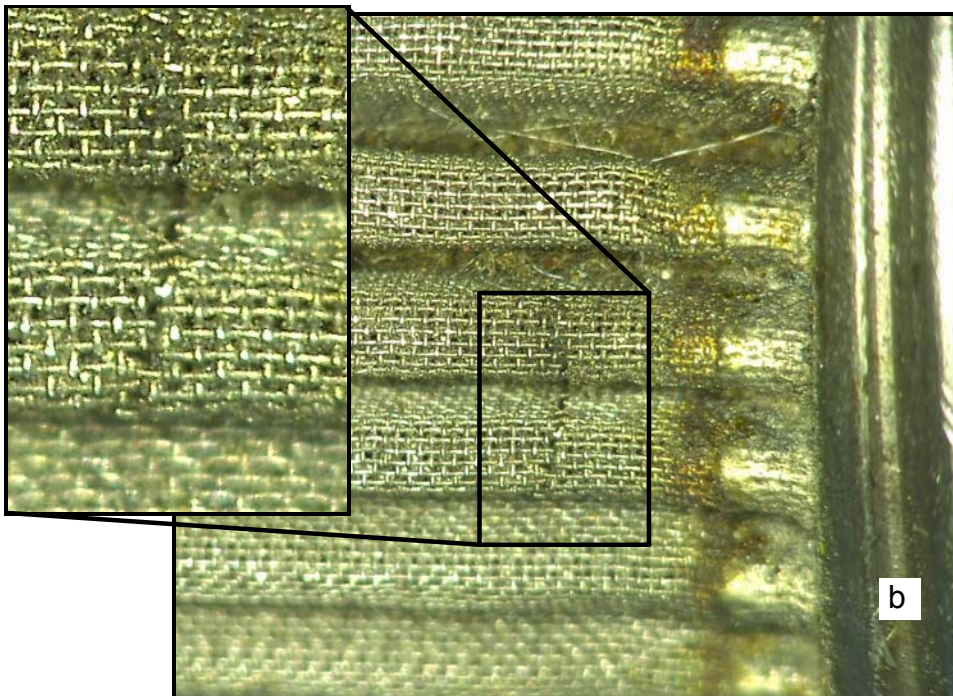
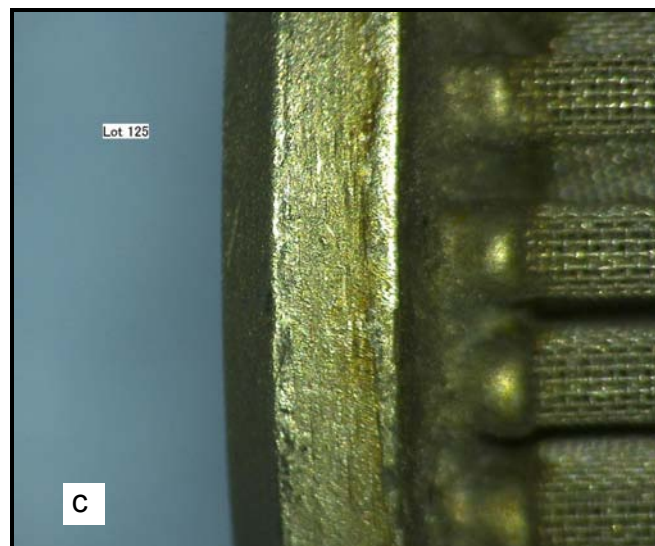
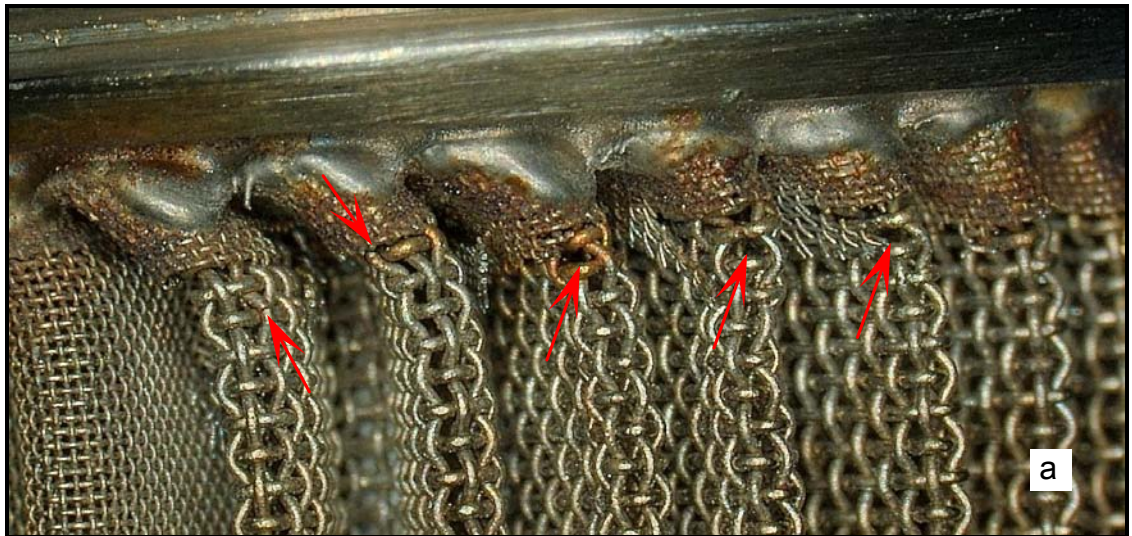

Figure 11--Filter element from lot 125 (a) with cracks in the fine screen (b). Original machined finish on the end cap.

ImageNo: 0805A00632, Project No:2008020012



ImageNo:0805A00636, Project No:2008020012



ImageNo:0806A00199, Project No:2008020011

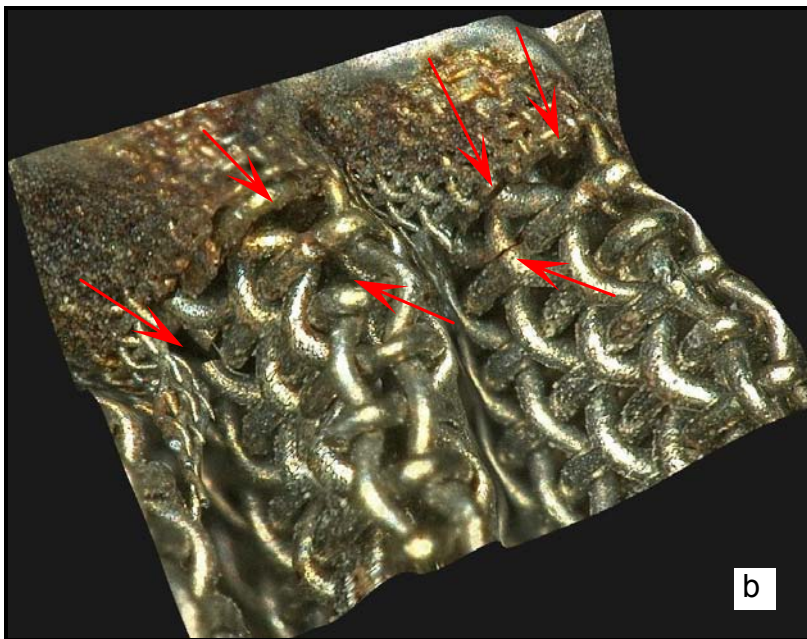

ImageNo: 0806A00205, Project No:2008020011

Figure 12--Views of typical fractured coarse screen wires (arrows) in the filter from lot 0067.

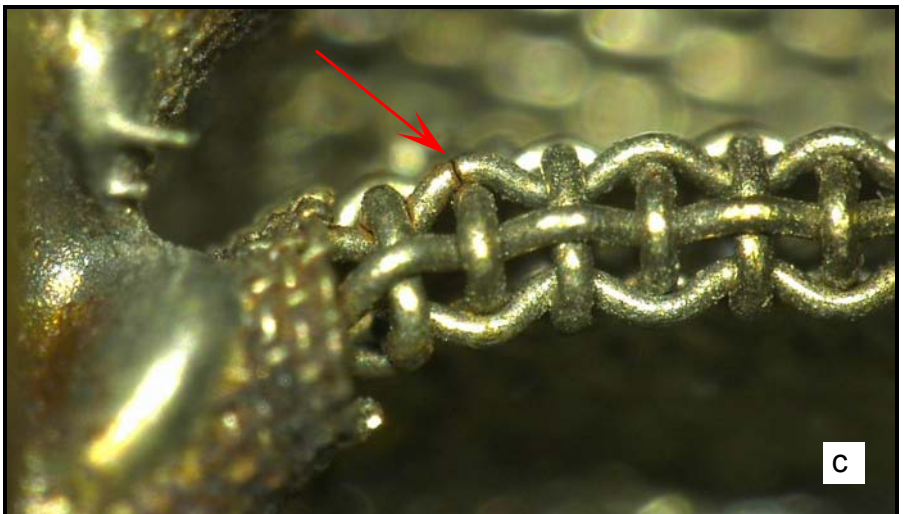

ImageNo:0806A00199, Project No:2008020011

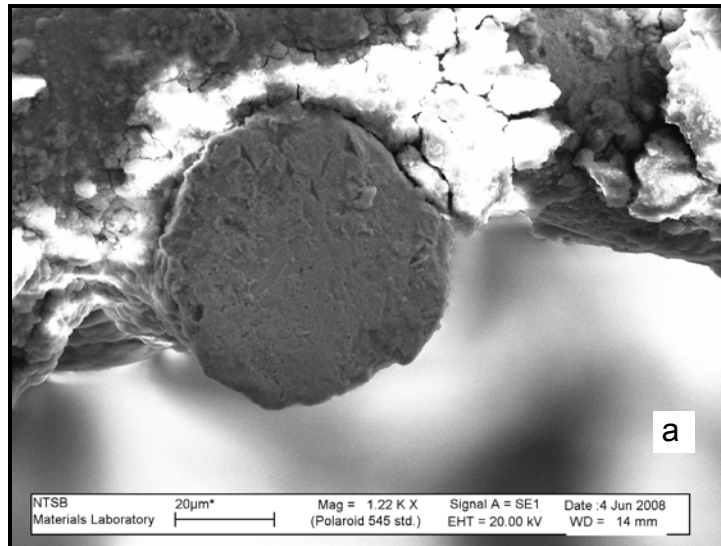

ImageNo:0806A00135, Project No:2008020011

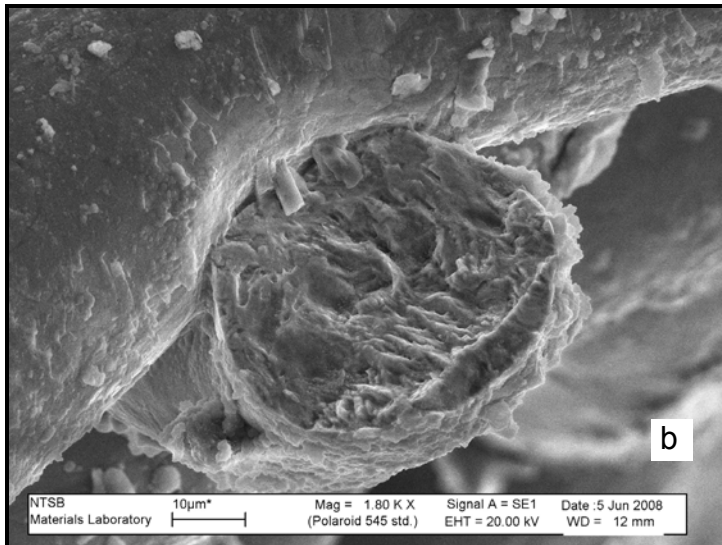

ImageNo: 0806A00129, Project No:2008020011

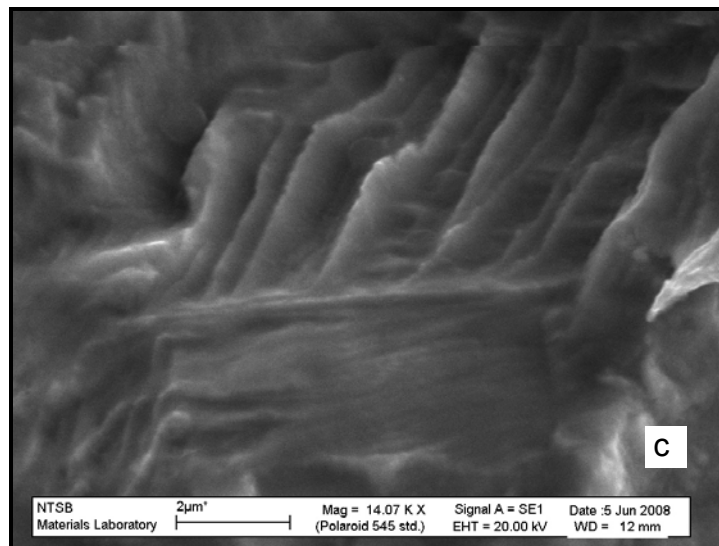

ImageNo:0806A00135, Project No:2008020011

Figure 13-- SEM views of fractured wires from the fine screen of lot 012. Damage wire in (a). Fatigue fractured wire in (b) with a high magnification view of fatigue features in (c).