

Crash Following Loss of Engine Power Due to
Fuel Exhaustion
Air Methods Corporation
Eurocopter AS350 B2, N352LN
Near Mosby, Missouri
August 26, 2011



Accident Report

NTSB/AAR-13/02
PB2013-104866



**National
Transportation
Safety Board**

NTSB/AAR-13/02
PB2013-104866
Notation 8479
Adopted April 9, 2013

Aircraft Accident Report

Crash Following Loss of Engine Power Due to
Fuel Exhaustion
Air Methods Corporation
Eurocopter AS350 B2, N352LN
Near Mosby, Missouri
August 26, 2011



**National
Transportation
Safety Board**

490 L'Enfant Plaza, S.W.
Washington, DC 20594

National Transportation Safety Board. 2013. *Crash Following Loss of Engine Power Due to Fuel Exhaustion, Air Methods Corporation, Eurocopter AS350 B2, N352LN, Near Mosby, Missouri, August 26, 2011.* Aircraft Accident Report AAR-13/02. Washington, DC: NTSB.

Abstract: This report discusses the August 26, 2011, accident involving a Eurocopter AS350 B2 helicopter, N352LN, which crashed following a loss of engine power as a result of fuel exhaustion near the Midwest National Air Center, Mosby, Missouri. The pilot, flight nurse, flight paramedic, and patient were killed, and the helicopter was substantially damaged by impact forces.

Safety issues identified in this accident include the following: distraction due to nonoperational use of portable electronic devices during flight and ground operations; the lack of Air Methods Operational Control Center involvement in decision-making; inadequate guidance on autorotation entry procedures; the need for simulator training of helicopter emergency medical services pilots; and the lack of a flight recorder. As a result of this investigation, the National Transportation Safety Board makes safety recommendations to the Federal Aviation Administration (FAA) and Air Methods Corporation, reiterates previous recommendations to the FAA, and reiterates and reclassifies a previous recommendation to the FAA.

The National Transportation Safety Board is an independent federal agency dedicated to promoting aviation, railroad, highway, marine, pipeline, and hazardous materials safety. Established in 1967, the agency is mandated by Congress through the Independent Safety Board Act of 1974 to investigate transportation accidents, determine the probable causes of the accidents, issue safety recommendations, study transportation safety issues, and evaluate the safety effectiveness of government agencies involved in transportation. The National Transportation Safety Board makes public its actions and decisions through accident reports, safety studies, special investigation reports, safety recommendations, and statistical reviews.

Recent publications are available in their entirety on the Internet at <http://www.nts.gov>. Other information about available publications also may be obtained from the website or by contacting:

**National Transportation Safety Board
Records Management Division, CIO-40
490 L'Enfant Plaza, SW
Washington, DC 20594
(800) 877-6799 or (202) 314-6551**

Copies of National Transportation Safety Board publications may be purchased from the National Technical Information Service. To purchase this publication, order product number PB2013-104866 from:

**National Technical Information Service
5285 Port Royal Rd.
Springfield, VA 22161
(800) 553-6847 or (703) 605-6000
<http://www.ntis.gov/>**

The Independent Safety Board Act, as codified at 49 U.S.C. Section 1154(b), precludes the admission into evidence or use of NTSB reports related to an incident or accident in a civil action for damages resulting from a matter mentioned in the report.

Contents

Figures.....	iii
Abbreviations and Acronyms	iv
Executive Summary	vi
1. The Accident.....	1
1.1 The History of Flight	1
1.1.1 Events Before the Accident Flight.....	1
1.1.2 The Accident Flight	4
1.2 Wreckage Information	7
1.3 Pilot Information.....	10
1.3.1 Work/Rest/Sleep History	11
1.4 Helicopter Information.....	13
1.4.1 Eurocopter AS350 B2 Fuel System.....	14
1.4.2 Fuel Quantity Calculations	16
1.4.3 Engine Failure Emergency Procedure	16
1.5 Tests and Research.....	17
1.5.1 Fuel System Component Examination	17
1.5.2 Certification Flight Tests for Controllability Following Engine Failure.....	18
1.5.3 Simulator Flight Evaluations	19
1.6 Company Information.....	19
1.7 Autorotation Guidance.....	22
2. Investigation and Analysis	24
2.1 General.....	24
2.2 Pilot’s Actions During Preflight and Departure for the Hospital	24
2.3 Pilot’s Decision to Continue the Mission	25
2.4 Pilot Human Factors	27
2.4.1 Distraction Due to Text Messaging During Flight and Ground Operations.....	27
2.4.2 Fatigue	31
2.5 Lack of Operational Control Center Involvement in Decision-Making	33
2.6 Autorotation Guidance and Training	36
2.6.1 Loss of Engine Power and Autorotation Entry	36
2.6.2 Inadequate Guidance on Autorotation Entry Procedures	37
2.6.3 Need for Simulator Training of Helicopter Emergency Medical Services Pilots	39
2.7 Lack of Flight Recorder	41
3. Conclusions.....	44
3.1 Findings.....	44
3.2 Probable Cause.....	45

4. Recommendations46
4.1 New Recommendations46
4.2 Previously Issued Recommendations Reiterated in This Report47
4.3 Previously Issued Recommendation Reiterated and Reclassified in This Report48

Board Member Statements49

References53

Figures

Figure 1. Map showing locations of STJ, GPH, Harrison County Community Hospital, Liberty Hospital, and the accident site.....	2
Figure 2. Photograph of the cockpit of an exemplar helicopter.....	3
Figure 3. Flight track of the last few miles of the accident flight showing radar data (red dots) and Air Methods satellite tracking system data (blue dots).....	7
Figure 4. Photograph of the accident site.....	8
Figure 5. Diagram showing the estimated impact attitude of the helicopter.	9
Figure 6a. Timeline of the pilot’s communications from 1400 to 1700.....	12
Figure 6b. Timeline of the pilot’s communications from 1700 to the accident about 1841.....	13
Figure 7. Diagram of the instrument panel, the fuel quantity gauge, and the caution/warning annunciator panel.....	15
Figure 8. Photograph of the fuel system component examination setup.	17
Figure 9. Air Methods flight risk assessment risk matrixes at the time of the accident.	21
Figure 10. Airflow through the main rotor system during normal, powered flight and during autorotation.	22

Abbreviations and Acronyms

AC	advisory circular
agl	above ground level
AirCom	Air Methods Communication Center
CFR	<i>Code of Federal Regulations</i>
CRM	crew resource management
CVR	cockpit voice recorder
CYA	conform your aircraft
EMS	emergency medical services
EUROCAE	European Organization for Civil Aviation Equipment
FAA	Federal Aviation Administration
FDR	flight data recorder
FTD	flight training device
GOM	general operations manual
GPH	Midwest National Air Center
HEMS	helicopter emergency medical services
InFO	Information for Operators
LARS	lightweight aircraft recording system
nm	nautical miles
NPRM	notice of proposed rulemaking
NTSB	National Transportation Safety Board

NTSB	
NVG	night vision goggles
OCC	operational control center
PED	portable electronic device
PIC	pilot-in-command
RFM	rotorcraft flight manual
STJ	Rosecrans Memorial Airport
TSO	technical standard order
VFR	visual flight rules

Executive Summary

On August 26, 2011, about 1841 central daylight time, a Eurocopter AS350 B2 helicopter, N352LN, crashed following a loss of engine power as a result of fuel exhaustion near the Midwest National Air Center (GPH), Mosby, Missouri. The pilot, flight nurse, flight paramedic, and patient were killed, and the helicopter was substantially damaged by impact forces. The emergency medical services (EMS) helicopter was registered to Key Equipment Finance, Inc., and operated by Air Methods Corporation, doing business as LifeNet in the Heartland, as a 14 *Code of Federal Regulations* Part 135 medical flight. Day visual meteorological conditions prevailed at the time of the accident, and a company visual flight rules flight plan was filed. The helicopter was not equipped, and was not required to be equipped, with any onboard recording devices. The flight originated from Harrison County Community Hospital, Bethany, Missouri, about 1811 and was en route to GPH to refuel. After refueling, the pilot planned to proceed to Liberty Hospital, Liberty, Missouri, which was located about 7 nautical miles (nm) from GPH.

The helicopter impacted the ground in about a 40° nose-down attitude at a high rate of descent with a low rotor rpm. Wreckage examination determined that the engine lost power due to fuel exhaustion and that the fuel system was operating properly. The investigation revealed that the pilot did not comply with several company standard operating procedures that, if followed, would have led him to detect the helicopter's low fuel state before beginning the first leg of the mission (from the helicopter's base in St. Joseph, Missouri, to Harrison County Community Hospital). After reaching the hospital, the pilot reported to the company's EMS communication center that he did not have enough fuel to fly to Liberty Hospital and requested help locating a nearby fuel option. During their conversation, the pilot did not report and the communication specialist did not ask how much fuel was on board the helicopter, and neither of them considered canceling the mission and having fuel brought to the helicopter. After determining that GPH was the only airport with Jet-A fuel along the route of flight to Liberty Hospital, the pilot decided to proceed to GPH, although the estimated flight time to GPH was only 2 minutes shorter than that to Liberty Hospital. The engine lost power about 1 nm short of the airport, and the pilot did not make the flight control inputs necessary to enter an autorotation, which resulted in a rapid decay in rotor rpm.

The safety issues identified in this accident include the following:

- **Distraction due to nonoperational use of portable electronic devices during flight and ground operations.** Review of cell phone records indicated that the pilot sent and received multiple personal text messages throughout the day, including during time periods when the helicopter was in flight and while it was on the ground at Harrison County Community Hospital. The pilot's texting, which occurred (1) while flying, (2) while the helicopter was being prepared for return to service, and (3) during his telephone call to the communication specialist when making his decision to continue the mission, was a self-induced distraction that took his attention away from his primary responsibility to ensure safe flight operations. Further, although there is no evidence that the pilot was texting at the time of the

engine failure, his texting while airborne violated the company's cell phone use policy.

- **Lack of Air Methods Operational Control Center (OCC) involvement in decision-making.** Although the pilot reported his low fuel situation to the communication specialist, he did not request and was not referred to the company's OCC or to someone such as the chief pilot who would likely have asked how much fuel was on board the helicopter and proposed canceling the mission. If the communication specialist or the pilot had notified operationally qualified personnel about the low fuel situation, the accident might have been averted. Both the Federal Aviation Administration (FAA) and the National Transportation Safety Board (NTSB) have emphasized the importance of having someone outside the immediate situation with operational experience provide an independent judgment on the safety of a launch in air medical operations.
- **Inadequate guidance on autorotation entry procedures.** The simulator flight tests conducted after this accident showed that when a loss of engine power occurs in the Eurocopter AS350 B2 at cruise airspeeds, the pilot must simultaneously apply aft cyclic and down collective in order to maintain rotor rpm and execute a successful autorotation. However, the pilot's autorotation training was done at airspeeds below cruise where less aft cyclic is needed to enter an autorotation. Further, FAA guidance on performing autorotations stresses lowering the collective as the initial step in entering an autorotation, does not emphasize the importance of other flight control inputs, and provides minimal information on the critical entry phase of autorotations.
- **Need for simulator training of helicopter emergency medical services (HEMS) pilots.** The pilot had not received any flight training in a simulator. Simulators enable pilots to train in skills that are too risky to perform in a helicopter, such as the low altitude engine failure in this accident, and a simulator can accurately replicate the symptoms of an actual engine flameout. If the pilot had received autorotation training in a simulator rather than a helicopter, he would have been better prepared and might have effectively responded to the engine failure during the accident flight. This accident highlights the value of using simulators and flight training devices for HEMS pilot training.
- **Lack of a flight recorder.** The helicopter was not required to have any type of crash-resistant recorder installed. If a recorder system that captured cockpit audio, images, and parametric data had been installed, it would have enabled NTSB investigators to reconstruct the final moments of the accident flight and determine why the pilot did not successfully enter an autorotation.

The NTSB determines that the probable causes of this accident were the pilot's failure to confirm that the helicopter had adequate fuel on board to complete the mission before making the first departure, his improper decision to continue the mission and make a second departure after he became aware of a critically low fuel level, and his failure to successfully enter an autorotation when the engine lost power due to fuel exhaustion. Contributing to the accident

were (1) the pilot's distracted attention due to personal texting during safety-critical ground and flight operations, (2) his degraded performance due to fatigue, (3) the operator's lack of a policy requiring that an operational control center specialist be notified of abnormal fuel situations, and (4) the lack of practice representative of an actual engine failure at cruise airspeed in the pilot's autorotation training in the accident make and model helicopter.

As a result of this investigation, the NTSB makes safety recommendations to the FAA and Air Methods Corporation, reiterates previous recommendations to the FAA, and reiterates and reclassifies a previous recommendation to the FAA.

1. The Accident

1.1 The History of Flight

On August 26, 2011, about 1841 central daylight time,¹ a Eurocopter AS350 B2 helicopter, N352LN, crashed following a loss of engine power as a result of fuel exhaustion near the Midwest National Air Center (GPH), Mosby, Missouri. The pilot, flight nurse, flight paramedic, and patient were killed, and the helicopter was substantially damaged by impact forces. The emergency medical services (EMS) helicopter was registered to Key Equipment Finance, Inc., and operated by Air Methods Corporation, doing business as LifeNet in the Heartland, as a 14 *Code of Federal Regulations* (CFR) Part 135 medical flight. Day visual meteorological conditions prevailed at the time of the accident, and a company visual flight rules (VFR) flight plan² was filed.³ The helicopter was not equipped, and was not required to be equipped, with any onboard recording devices.⁴ The flight originated from Harrison County Community Hospital, Bethany, Missouri, about 1811 and was en route to GPH to refuel. After refueling, the pilot planned to proceed to Liberty Hospital, Liberty, Missouri, which was located about 7 nautical miles (nm) from GPH.

1.1.1 Events Before the Accident Flight

The helicopter was based at the Rosecrans Memorial Airport (STJ), St. Joseph, Missouri (St. Joseph base). Figure 1 shows the locations of STJ, GPH, Harrison County Community Hospital, Liberty Hospital, and the accident site.

¹ Unless otherwise indicated, all times in this report are central daylight time based on a 24-hour clock.

² Air Methods has approval from the Federal Aviation Administration (FAA) for its pilots to file VFR flight plans that remain within the company, rather than being filed with the FAA.

³ More information about this accident, National Transportation Safety Board case number CEN11FA599, is available online at <http://www.nts.gov/aviationquery/index.aspx>.

⁴ See section 2.7 of this report for information on the need for flight recorders in all turbine-powered, nonexperimental, nonrestricted-category aircraft.

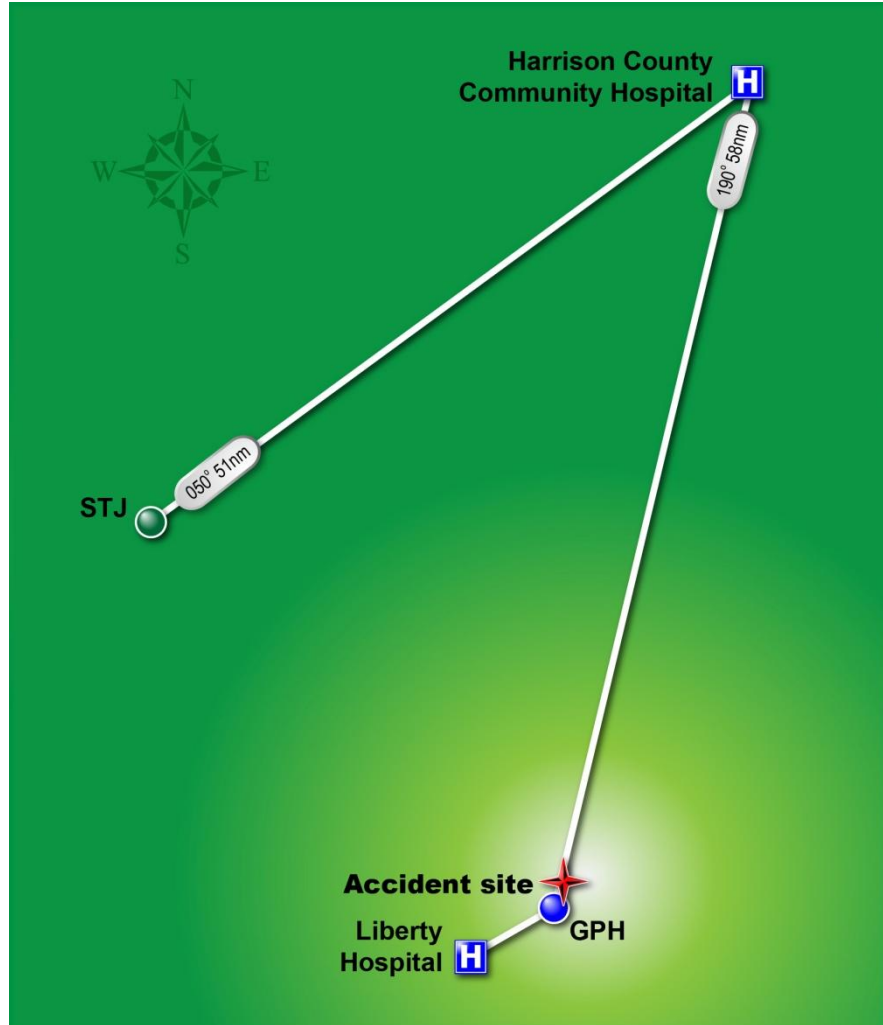

Figure 1. Map showing locations of STJ, GPH, Harrison County Community Hospital, Liberty Hospital, and the accident site.

During the week before the accident flight, Air Methods conducted night vision goggle (NVG) pilot training at the St. Joseph base. Maintenance records indicate that on August 22, 2011, the accident helicopter was configured for use in the NVG training; the medical interior was removed, and the copilot's seat, cyclic, collective, and pedals were installed. Figure 2 is a photograph of the cockpit of an exemplar helicopter in the training configuration. While the accident helicopter was being used for the NVG training, another Air Methods Eurocopter AS350 B2, N101LN, was used by the St. Joseph base for EMS flights.

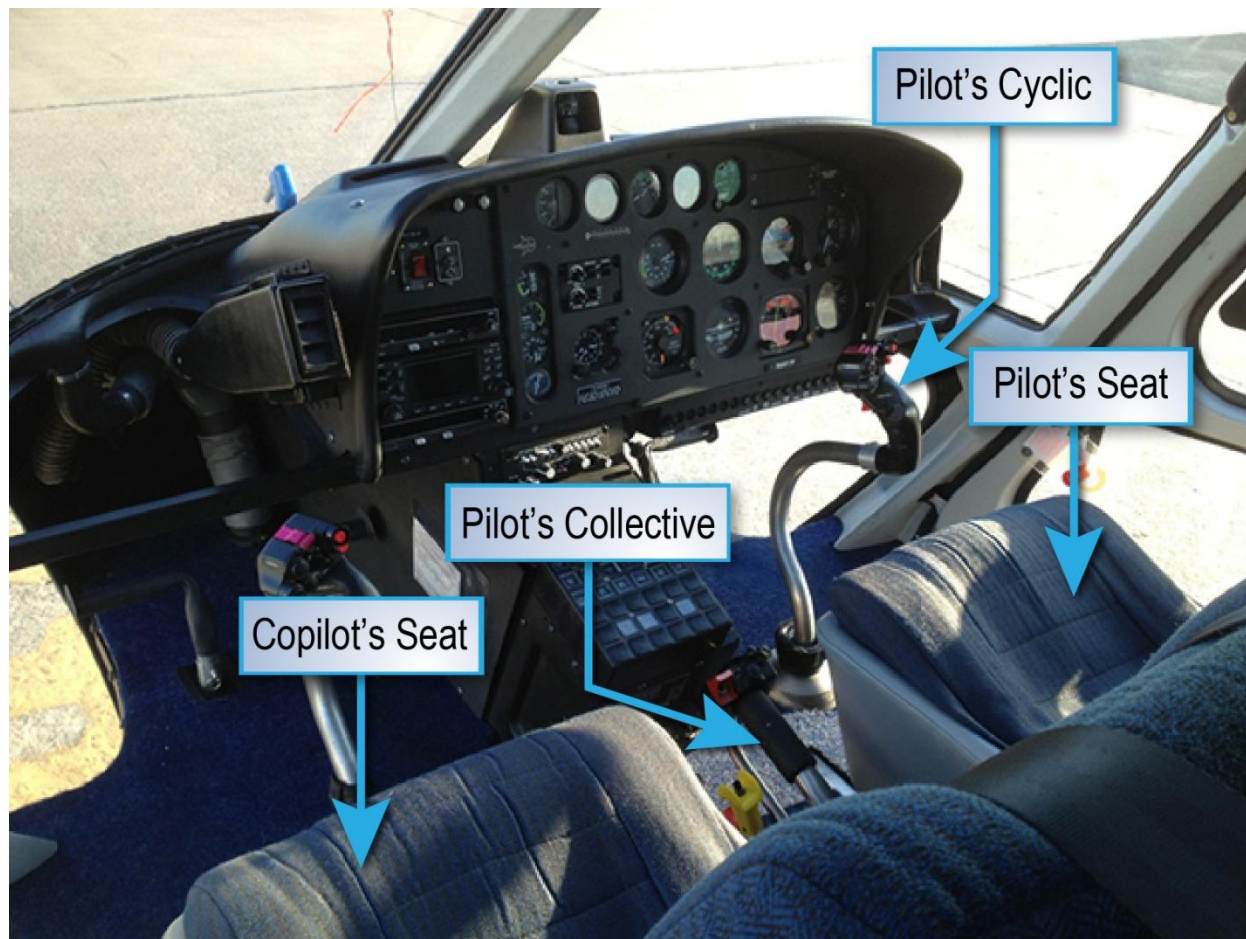

Figure 2. Photograph of the cockpit of an exemplar helicopter.

The last NVG training flight in the helicopter was completed about 0300 on August 26, 2011. The Air Methods instructor who was providing the training reported that he did not have the helicopter refueled after the last flight because the EMS pilot on duty needed to determine the amount of fuel required when the helicopter was returned to EMS service. According to the St. Joseph base lead pilot, the duty helicopter was typically loaded with a 70 percent fuel load, which provided about 2 hours of fuel. Fuel records obtained from the STJ airport manager showed that the helicopter was not refueled on August 26.

The accident pilot reported for duty on the day of the accident about 0630. He received a briefing from the departing night shift pilot that covered the status of the active helicopter (N101LN) and the status of the accident helicopter. Regarding the accident helicopter, the night shift pilot reported that the NVG training had been completed, the helicopter needed to be reconfigured for medical work by the mechanic, and the helicopter was low on fuel and needed to be refueled before it was used. Because the accident helicopter was still awaiting

reconfiguration for EMS flights, the pilot conducted a preflight inspection of N101LN and signed its daily flight log as required by the Air Methods General Operations Manual (GOM).⁵

The helicopter mechanic arrived about 0700 and began to reconfigure the accident helicopter for EMS work by removing the copilot's seat, cyclic, collective, and pedals and reinstalling the medical interior. About 1400, the mechanic told the pilot that the work was complete, and they performed a "walk-around" inspection of the helicopter so that the mechanic could show the pilot what had been done. The mechanic then went inside to perform other duties. As he did so, the flight nurse and flight paramedic began to prepare the cabin for duty, and the pilot began to transfer his gear and paperwork from the active helicopter to the accident helicopter. The crew's readying of the helicopter normally took about an hour, according to the helicopter mechanic, and he recalled that the accident helicopter had been moved out of the hangar to a nearby ramp area and was ready for service by 1530 because the crew came into the trailer where he was working about that time.

Company procedures required that the pilot perform a preflight inspection of the helicopter, which included checking the fuel quantity, before it was returned to service. The mechanic did not know whether the pilot performed a preflight inspection of the helicopter before departing on the accident trip. Examination of the helicopter's daily flight log revealed that the pilot did not sign it as required by the GOM to indicate that he had completed the preflight inspection. The pilot also did not take fuel samples from the helicopter on the day of the accident as required by the GOM.⁶ Further, three "conform your aircraft" (CYA) entries dated August 26, 2011, were made by the mechanic in the helicopter's maintenance logbook, but the pilot did not initial the CYA entries as required by the GOM.⁷

1.1.2 The Accident Flight

The purpose of the flight was to transport a patient from Harrison County Community Hospital to Liberty Hospital. The Air Methods Communication Center (AirCom)⁸ received the request about 1719, and the pilot was notified about 1720. During the initial notification, the pilot accepted the flight, and he and the flight paramedic and flight nurse prepared to depart. The helicopter became airborne about 1728. About 1730, the pilot reported by radio to the AirCom communication specialist that the helicopter had departed STJ with

⁵ The Air Methods GOM, page C-2/R-5/01-15-11, states, "The pilot shall record the preflight/airworthiness check by signing the appropriate section of the Daily Flight Log."

⁶ The Air Methods GOM, page B-19/R-4/11-09-09, states, "At the beginning of each shift the pilot conducting the preflight will perform the following: • Aircraft fuel system: SUMP to collect a fuel sample and check for proper type and contaminates. • If fuel sample is contaminated, contact maintenance for further guidance. NOTE: For all Aircraft the two most recent fuel samples will be kept: After required periods, fuel samples shall be discarded appropriately."

⁷ The Air Methods GOM, page B-28/R-5/01-15-11, states, "For all routine maintenance performed in the field by a company mechanic, a CYA check will be performed. If a second mechanic is unavailable to perform the check, a pilot may perform the check, and will initial the CYA entry in the Record of Maintenance." According to the GOM, a CYA check is a postmaintenance visual inspection of a mechanic's work. In this case, the three items that required a CYA check were the reconfiguration of the helicopter's interior for medical service, a daily/5-hour engine chip detector inspection, and the mechanic's daily airworthiness inspection of the helicopter.

⁸ AirCom is an EMS communications center staffed with communication specialists, who are not certified aircraft dispatchers. See section 1.6 of this report for further information on AirCom.

2 hours of fuel and 3 persons on board with a risk code “Blue” (B-Caution).⁹ About 1758, the helicopter landed at the Harrison County Community Hospital helipad to pick up the patient.

After the helicopter was shut down on the Harrison County Community Hospital helipad, the flight nurse and flight paramedic took their stretcher to the hospital’s emergency room to prepare the patient for flight. The pilot stayed in the helicopter and, about 1759, contacted the AirCom communication specialist using his company-provided cell phone and notified him that they had landed at the hospital. He also reported that about halfway through the flight from STJ, he had realized that the helicopter did not have as much fuel on board as he originally thought. He stated that he had reported the fuel from N101LN, not from the accident helicopter, and that he would have to stop somewhere and obtain fuel. The communication specialist asked the pilot if he could make it to Liberty Hospital and informed him that the distance to Liberty Hospital was 62 nm, with an estimated time en route of about 34 minutes. The pilot then stated, “That’s going to be cutting it pretty close. I’m probably going to need to get fuel before that.”

The communication specialist and the pilot checked for availability of Jet-A fuel at nearby airports and found that the only airport with Jet-A fuel along the route of flight to Liberty Hospital was GPH, which was 58 nm away. After the communication specialist informed the pilot that the distance to GPH was 58 nm, the pilot stated, “Fifty-eight nautical miles. So it would save me, save me 4 nautical miles and 2 minutes. I think that’s probably where I’m going to end up going.”¹⁰

The communication specialist asked the pilot if he was going to depart for GPH for fuel and then return for the patient pick-up or if the pilot intended to refuel with the patient on board. The pilot informed the dispatcher that he would refuel at GPH with the patient on board. The pilot stated, “I don’t want to run short and I don’t want to run into that 20-minute reserve^[11] if I don’t have to...,” and “we’ll take off. I’ll see how much gas I have when I got and I’ll call you when we’re in the air.”

Review of AirCom transcripts revealed that while the communication specialist and the pilot were checking for possible fuel alternatives, the communication specialist also responded to three calls from two other Air Methods EMS helicopters concerning medical coordination information.¹² Neither the pilot nor the communication specialist discussed contacting the

⁹ See section 1.6 of this report for information about Air Methods’ risk assessment program.

¹⁰ Using a ground speed of 110 knots, which was the speed used by Air Methods for flight planning for the helicopter, a 58 nm flight would take 32 minutes. Therefore, in comparison to a flight to Liberty Hospital, a flight to GPH would be 4 nm and 2 minutes shorter.

¹¹ Title 14 CFR 135.209(b) states, “No person may begin a flight operation in a helicopter under VFR unless, considering wind and forecast weather conditions, it has enough fuel to fly to the first point of intended landing and, assuming normal cruising fuel consumption, to fly after that for at least 20 minutes.”

¹² The AirCom communication specialist was responsible for providing EMS flight following for five Air Methods EMS bases.

Air Methods Operational Control Center (OCC)¹³ to inform the OCC of the low fuel situation or the changed flight route.

The conversation between the pilot and the communication specialist began just before the communication specialist completed his scheduled 12-hour work day, with the shift change time normally occurring about 1800. About 1806, the off-going day communication specialist briefed the on-coming night communication specialist regarding the status of all of the EMS helicopters that were currently dispatched, including the accident helicopter and its fuel situation, and the status of all of the EMS bases that were handled by their sector. Neither of the communication specialists mentioned notifying the OCC concerning the status of the accident helicopter. Following the shift change briefing, the day communication specialist remained on duty until about 1820 to complete the communications related to the accident helicopter's low fuel situation.

About this time, the flight nurse and flight paramedic arrived back at the helicopter and loaded the patient into the helicopter. Two hospital emergency room nurses who assisted the medical flight crew reported that neither medical crewmember mentioned anything unusual about the helicopter or its fuel status.

About 1811, the helicopter departed from the Harrison County Community Hospital helipad, and the pilot reported via radio to the AirCom day communication specialist that he had 45 minutes of fuel and four persons on board with a risk code "Blue" and was en route to GPH. About 1813, the pilot requested that the AirCom communication specialist contact the fixed-base operator at GPH to indicate that the helicopter was inbound for fuel. The day communication specialist acknowledged the pilot's radio transmission and stated that he would notify GPH that the helicopter would be landing for fuel.

About 1815, the day communication specialist notified the AirCom supervisor that the helicopter was low on fuel and would be refueling with the patient on board at GPH. The supervisor directed him to contact the medical base supervisor at St. Joseph, but the day communication specialist informed him that the medical base supervisor was the flight nurse on board the helicopter.

About 1821, the night communication specialist contacted the fixed-base operator at GPH and informed him that the helicopter was inbound for fuel and would be arriving in about 19 minutes. About 1827, the night communication specialist notified the pilot via radio that the fuel arrangement had been made at GPH. The pilot acknowledged the radio transmission, which was the last recorded transmission from the pilot.

Combined radar data and Air Methods satellite tracking system data indicated that after departing from the hospital helipad, the helicopter headed directly toward GPH. En route to GPH, the helicopter's altitude averaged between 400 and 600 feet above ground level (agl) with

¹³ The Air Methods GOM, page I-3/R-5/01-15-11, states that the communication specialist shall notify the OCC of all overdue aircraft, accidents, incidents, damage to aircraft, unscheduled landings, in-flight weather, and maintenance aborts. At the time of the accident, Air Methods did not require the communication specialist to notify the OCC of fuel-related issues or unplanned deviations. See section 1.6 of this report for further discussion of the OCC.

an average ground speed of 111 to 116 knots. The last few minutes of data showed the helicopter in a shallow descent. About 1841, the last satellite tracking system position recorded was about 0.9 nm from the accident site and showed the helicopter was about 373 feet agl with a 116-knot ground speed. Figure 3 shows the last few miles of flight track data.

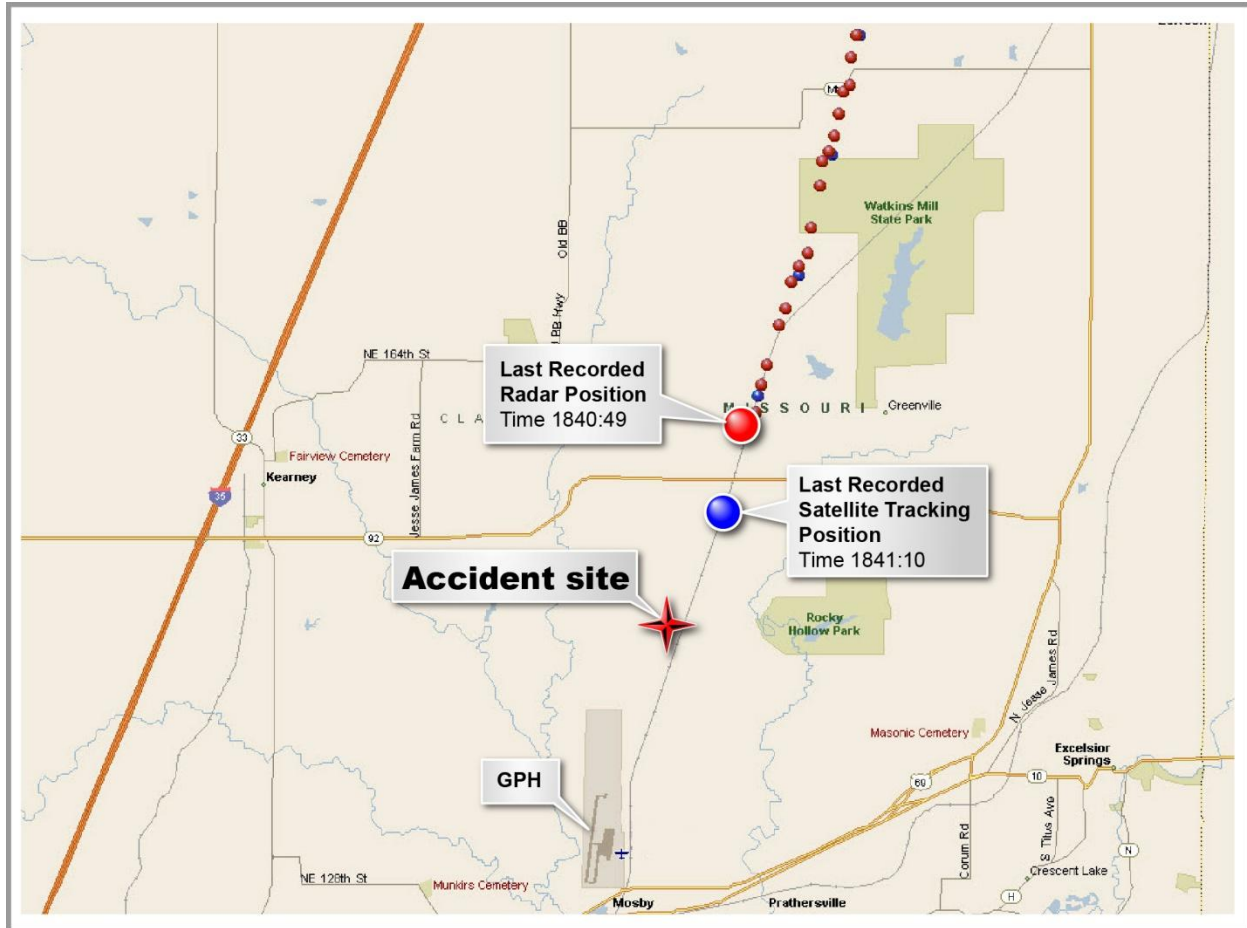

Figure 3. Flight track of the last few miles of the accident flight showing radar data (red dots) and Air Methods satellite tracking system data (blue dots).

There were no witnesses to the accident. When the pilot did not report arriving at GPH, the AirCom communication specialist called the fixed-base operator, and the wreckage was located shortly thereafter in a farm field about 1 nm from the approach end of runway 18 at GPH.

1.2 Wreckage Information

As shown in figure 4, the aircraft structure was heavily fragmented and scattered along a 100-foot-long debris path, which was oriented on a heading of about 242°.



Figure 4. Photograph of the accident site.

The wreckage displayed vertical crush damage consistent with impact at a high rate of descent. The main rotor blades remained attached to the rotor hub, were bent but not twisted, and had minimal leading-edge damage. Similarly, the tail rotor blades exhibited little impact damage and were relatively straight, although one blade was partially separated at the blade root. The damage to the main and tail rotor blades was consistent with a low rotor rpm at impact. The impact signatures to the components of the airframe structure were consistent with the initial impact occurring in a 40° nose-low and slight left-bank attitude, on a heading of about 030° (nearly opposite to the direction of travel). Figure 5 is a diagram illustrating the estimated impact attitude of the helicopter.

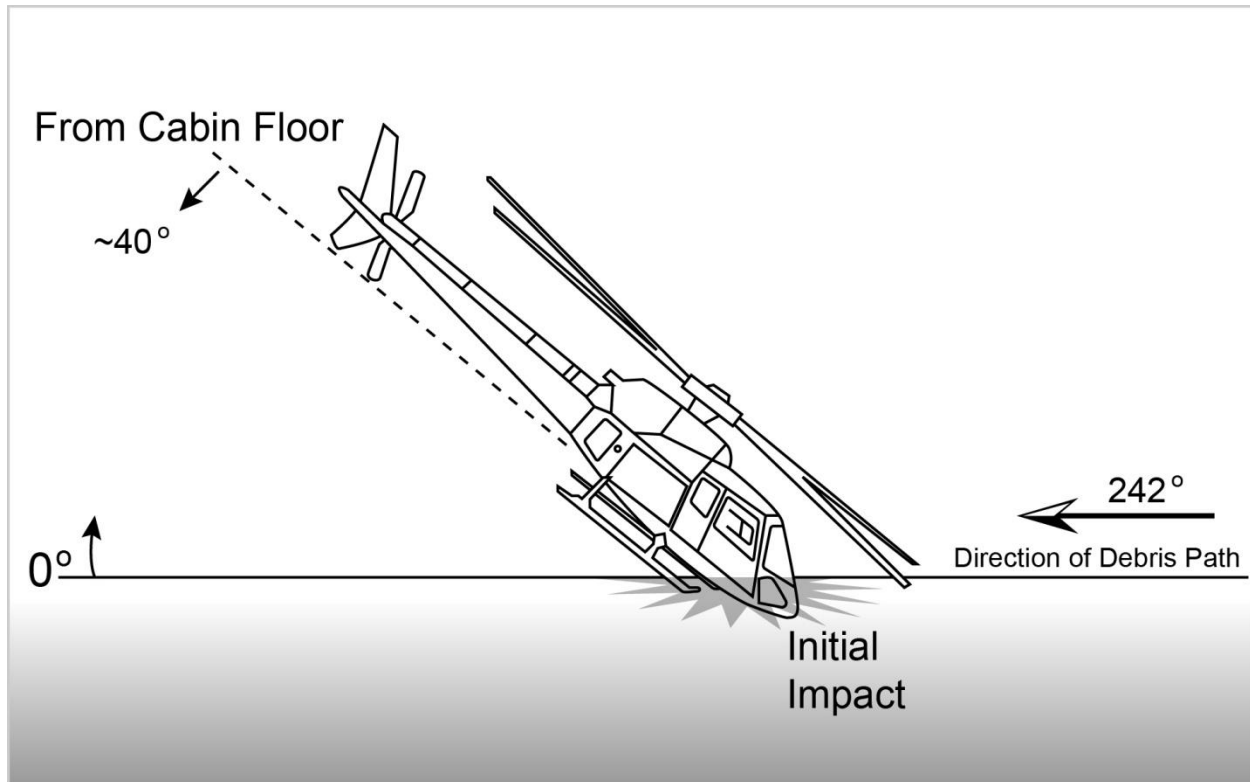

Figure 5. Diagram showing the estimated impact attitude of the helicopter.

There was no postimpact fire. The fuel tank assembly was found intact and located in the midst of the main wreckage. No fuel was observed at the accident site. Less than 1 liter of fuel was found in the fuel tank and lines, which were generally intact. The airframe fuel filter system was examined. No fuel was observed in the lines on the engine side of the filter, and only a residual amount of fuel was observed in the lines on the tank side of the filter. The evidence was consistent with a loss of engine power due to fuel exhaustion occurring shortly before impact.

Examination of the engine revealed damage consistent with the engine rotating but not producing power at impact. The axial compressor displayed substantial blade curling and significant foreign object damage, which indicated that the gas generator was rotating at a high rpm at the time of impact. Unmelted aluminum shavings resulting from contact at impact between the rotating axial compressor and the intake plenum were found in the engine's turbine section, which indicated that the engine was flamed out when impact occurred.¹⁴ According to the engine manufacturer, after shutdown, the gas generator speed drops from 97 percent to 30 percent within 5 seconds and to 15 percent after 11 seconds. Because the damage signatures indicated that the gas generator was still rotating at a high rpm at impact, the engine manufacturer estimated that impact must have occurred within the first 10 seconds after flameout.

¹⁴ A flameout is a condition in the operation of a gas turbine engine in which the fire in the engine unintentionally goes out. If the engine had been operating normally at impact, the aluminum shavings would have been melted.

1.3 Pilot Information

The pilot, age 34, held a commercial pilot certificate with rotorcraft-helicopter and instrument-helicopter ratings issued on September 22, 2005. He held a Federal Aviation Administration (FAA) second-class medical certificate with no limitations issued on September 1, 2010. Before he was hired by Air Methods in September 2010, the pilot flew for the US Army, where he was a pilot-in-command (PIC) in the Boeing AH-64 Apache helicopter.¹⁵ He had no previous civil commercial flight experience.

On the resume that he provided to Air Methods, the pilot indicated that he had 2,071.1 total rotorcraft flight hours, of which 895.1 hours were as PIC and 1,675.4 hours were in twin-engine rotorcraft. Information provided by Air Methods indicated that the pilot accumulated a total of 104 flight hours in the Eurocopter AS350 B2 and 32 flight hours in the Eurocopter AS350 B3 between October 10, 2010, and August 26, 2011. His estimated total rotorcraft flight time at the time of the accident was about 2,207 hours. He flew 18 hours within the 30 days before the accident and 74 hours within the 90 days before the accident.

Pilot training records showed that the pilot started his basic indoctrination training with Air Methods on September 13, 2010. After receiving 4.2 hours of flight training, on October 6, 2010, he satisfactorily completed an initial flight evaluation, which encompassed demonstration of current knowledge and competency (14 CFR 135.293), as well as demonstration of operational procedures (14 CFR 135.299). Power failures, autorotations¹⁶ to a power recovery (but without a reduction in power), and hovering autorotations (oral only) were performed. He was assigned to the St. Joseph base and completed his base orientation, which included three orientation flights, on October 11, 2010.

From March 14 to 16, 2011, the pilot received his initial NVG flight training and recurrent flight training. On March 16, 2011, he satisfactorily completed his most recent annual flight evaluation (14 CFR 135.293 and 135.299) and his NVG proficiency check. In total, the pilot received 12.3 hours of Eurocopter AS350 B2 flight training from Air Methods, and none of this training was conducted in a flight simulator.

On April 12, 2011, the pilot received differences training in a Eurocopter AS350 B3. The training was limited to ground training and covered preflight inspections and start procedures. On May 2, 2011, he transferred to Rapid City, South Dakota, where the base helicopter was a Eurocopter AS350 B3. At the time of the accident, the pilot was working at his original base in St. Joseph to help cover a temporary pilot shortage at that location. Since his transfer to Rapid City, he had worked most of his shifts at St. Joseph and had about 10 months of experience in the St. Joseph area.

¹⁵ The Boeing AH-64 Apache is a four-blade, twin-engine attack helicopter with a tailwheel-type landing gear arrangement and a tandem cockpit for a two-man crew.

¹⁶ An autorotation is the state of helicopter flight where the main rotor system is being turned by the action of air moving up through the rotor rather than engine power driving the rotor. See section 1.7 of this report for more information about autorotation.

1.3.1 Work/Rest/Sleep History

The pilot's activities in the days before the accident were reconstructed from electronic records¹⁷ and interviews of witnesses. The pilot was off duty for 5 days before the day of the accident. The accident flight was his first flight after returning to duty.

On Wednesday, August 24, 2 days before the accident, the pilot began the day at his parents' home in Lincoln, Nebraska. According to his wife, the pilot departed from his parents' home on Wednesday evening and spent the night with a friend in Manhattan, Kansas, on the way back to St. Joseph. Cell phone records indicate that the first activity recorded was an outbound text message about 1303, and the last activity recorded was an outbound text message about 2133.

On Thursday, August 25, the day before the accident, records indicated that the pilot checked into the layover hotel in St. Joseph about 1423. The pilot was scheduled to attend company training beginning about 1630 (which consisted of annual recurrent aircraft ground training). The pilot's wife spoke with him twice on Thursday by telephone, soon after he arrived at the hotel and later that evening, and indicated in a postaccident interview that he sounded good. A coworker (an Air Methods communication specialist) also spoke with the pilot by telephone that evening and reported in a postaccident interview that the pilot stated that his training went well. Cell phone records indicate that the first activity recorded was an inbound telephone call (44 seconds in duration) beginning about 1123, and the last activity recorded was an inbound telephone call (115 seconds in duration) ending about 0019 on Friday morning.

On Friday, August 26, the day of the accident, the pilot was scheduled to work the day shift from 0630 to 1830. According to his coworker, the pilot would typically awaken about 1 hour before reporting for duty. The departing night shift pilot whom he relieved indicated in a postaccident interview that the accident pilot arrived for work on time, if not early. They spent at least 20 minutes briefing the shift change, and the accident pilot seemed alert. When the mechanic arrived, he encountered the accident pilot, whom he described in a postaccident interview as being in a normal mood, chipper, and ready to go. About 0730, the departing flight nurse encountered the accident pilot and described him as his normal, boisterous self. The pilot's coworker indicated that during a telephone call about 0830, the pilot stated that he did not sleep well in the hotel and felt tired. About 1200, the accident pilot visited the mechanic in the hangar to ask about progress on the accident helicopter, and the mechanic and pilot walked together to the airport restaurant for lunch. They spoke about football and other general topics during the meal and returned to work about 1245.

According to cell phone records, the pilot made and received multiple personal calls and text messages throughout the day. Figures 6a and 6b show the timing of the cell phone calls and text messages with the timing of radio communications and flight activities from 1400 (the time identified by the mechanic as when he and the pilot began the walk-around inspection) until the accident about 1841. Figure 6a, which covers the time period from 1400 to 1700, shows that

¹⁷ The pilot's personal cell phone records were obtained from the cellular service provider. These records included the type of communication (call made, call received, text message sent, text message received), the time the communication began, and the time the communication ended. The records did not include the content of the text messages.

Figure 6b, which covers the time period from 1700 to the accident, shows that text messages were sent from the pilot’s cell phone during time periods when the helicopter was in flight on the accident leg and the preceding leg and while the helicopter was on the Harrison County Community Hospital helipad.

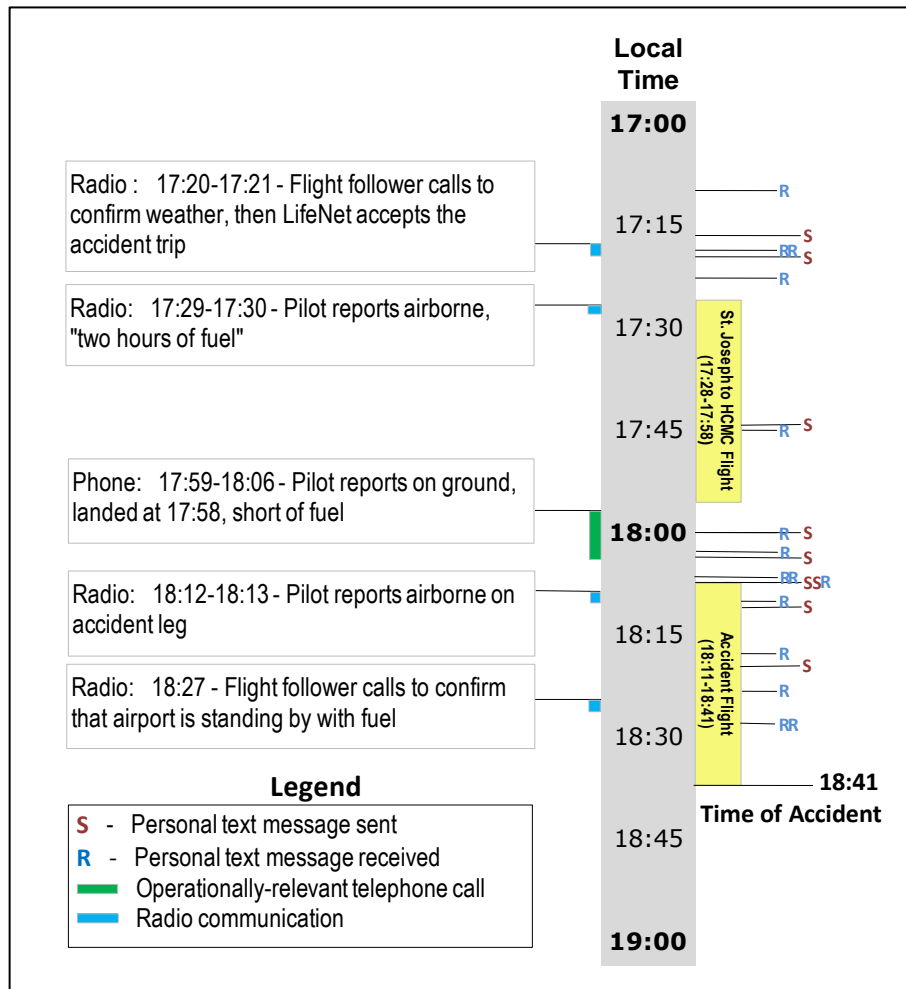

Figure 6b. Timeline of the pilot’s communications from 1700 to the accident about 1841.

1.4 Helicopter Information

The AS350 B2 helicopter was manufactured in France by Eurocopter in 2003 and acquired by Air Methods in 2005. It was equipped for VFR and NVG flights. It was powered by a single free turbine engine and equipped with a three-bladed main rotor system, a two-bladed tail rotor, and a skid-type landing gear. The helicopter’s interior was configured for transport and care of a single patient on a litter-type system installed on the left side of the aircraft. The instrument panel was configured with NVG lighting and filters. At the time of the accident, the helicopter had accumulated about 3,655 flight hours. A review of the helicopter’s maintenance records revealed no evidence of any uncorrected maintenance discrepancies.

1.4.1 Eurocopter AS350 B2 Fuel System

The fuel tank on the Eurocopter AS350 B2 is mounted in the fuselage body structure behind the passenger compartment and below the main transmission deck. It has a capacity of 143 gallons, of which 142 gallons are usable. Fuel is supplied from the fuel tank to the engine through the following components in turn: two booster pumps, a fuel filter, a bypass valve, and an emergency fuel cut-off. The fuel system controls and indicators available to the pilot are a fuel flow control lever, a fuel shutoff lever, a fuel quantity gauge, a fuel pressure gauge, a low fuel level light, a low fuel pressure light, and a fuel filter clogging light. The fuel quantity gauge is mounted at the top of the center instrument panel and indicates the percentage of fuel that is on board. Figure 7 is a diagram of the instrument panel showing the location of the fuel quantity gauge and the low fuel level light.

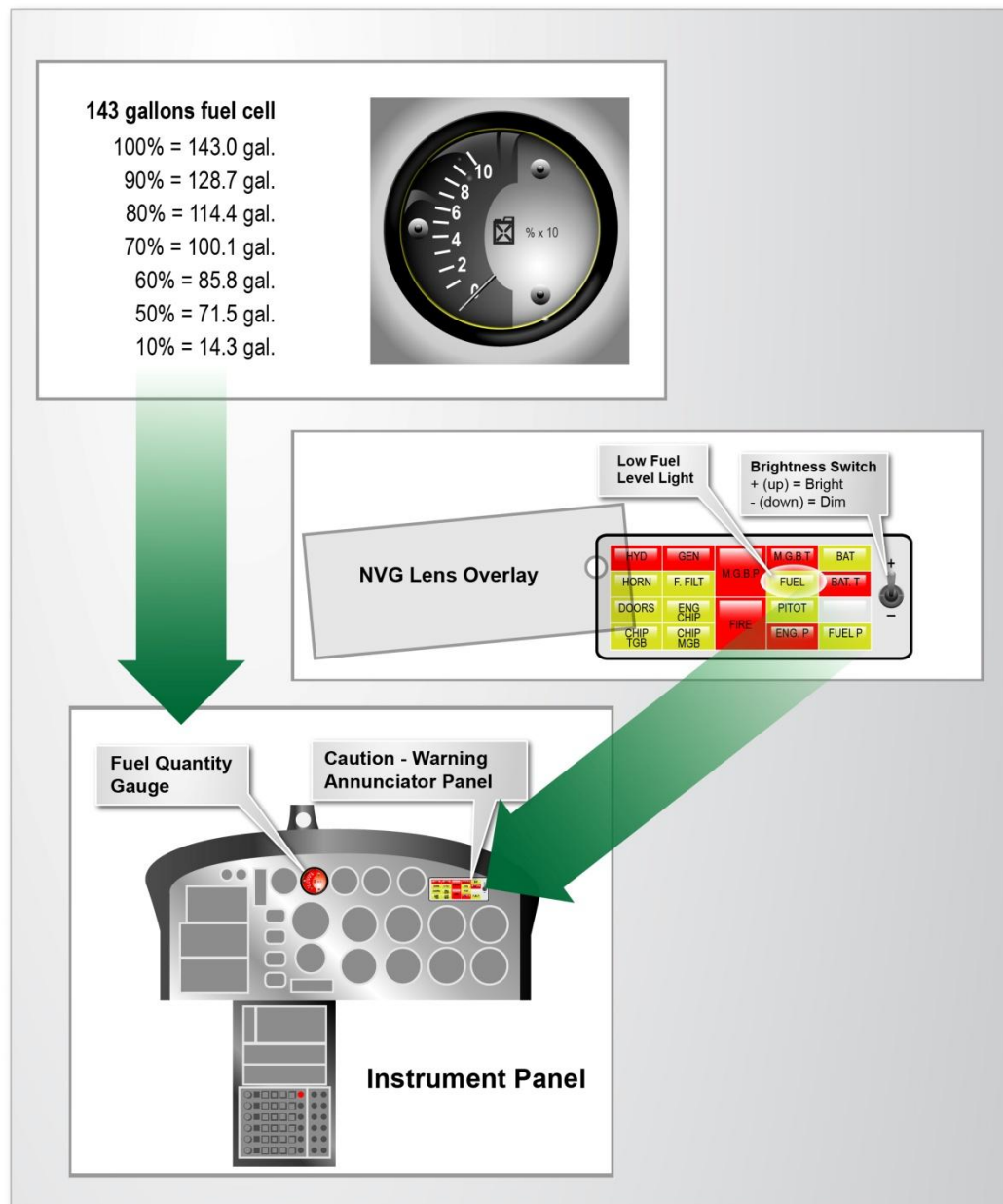

Figure 7. Diagram of the instrument panel, the fuel quantity gauge, and the caution/warning annunciator panel.

The low fuel level light is an amber-colored light labeled “FUEL” in the caution/warning annunciator panel located on the upper right portion of the pilot’s instrument panel. The light illuminates when the fuel quantity is below 11 percent (15.8 gallons). According to the Eurocopter AS350 B2 Rotorcraft Flight Manual (RFM), when the light illuminates, the pilot is to “Avoid large attitude changes.” The RFM also states, “Note: Remaining usable fuel allows approximately 18 minutes level flight at maximum continuous power.” According to flight test data provided by Eurocopter, the airspeed in level flight at maximum continuous power would be about 119 knots.

1.4.2 Fuel Quantity Calculations

The investigation revealed that the helicopter's fuel was exhausted shortly before impact. Working backwards from this point, the amounts of fuel in the helicopter on departure from the hospital helipad and from STJ were computed. A fuel chart at the St. Joseph base indicated that the fuel burn rate for the helicopter was about 35 percent per hour, which equated to about 50 gallons per hour. Using the 35 percent fuel burn rate, the 30-minute flight from Harrison County Community Hospital to the accident site would consume about 25 gallons of fuel. The 30-minute flight from STJ to Harrison County Community Hospital would also consume about 25 gallons of fuel. Not accounting for fuel consumed during aircraft start sequences, the helicopter had about 50 gallons (35 percent or about 60 minutes) of fuel when it departed STJ.

1.4.3 Engine Failure Emergency Procedure

Section 3 of the Eurocopter AS350 B2 RFM provides information regarding helicopter emergencies, the warnings or alerts associated with a particular emergency, and the procedures to follow once the emergency has been identified.

The main rotor rpm normal operating range is from 375 to 394 rpm and is represented by a green arc on the dual tachometer on the pilot's instrument panel.¹⁸ Continuous tone audio warnings are provided when rotor rpm is below 360 rpm.

Paragraph 3.1 in Section 3.1 of the RFM lists the following symptoms for an engine failure (flameout) in flight:

- Jerk in the yaw axis (only in high power flight).
- Drop in rotor speed (aural warning sounds below 360 rpm).
- Torque at zero.
- N_g [gas generator speed] falling off to zero.
- Generator warning light illuminates.
- Engine oil pressure drop warning light illuminates.

Paragraph 2.1 in Section 3.1 of the RFM provides the autorotation procedure to follow in the event of an in-flight engine failure. The first three steps of the procedure are the following:

- Set low collective pitch.
- Monitor and control rotor rpm.
- Establish approximately 65 k[no]t (120 km/hr – 75 mph) airspeed.

¹⁸ The dual tachometer is a single gauge that displays both free turbine speed and main rotor rpm.

1.5 Tests and Research

1.5.1 Fuel System Component Examination

Examination and testing of the helicopter's fuel tank assembly, the fuel quantity gauge, and the caution/warning annunciator panel were conducted under the supervision of National Transportation Safety Board (NTSB) investigators at American Eurocopter in Grand Prairie, Texas. No preimpact anomalies were identified. The fuel system performed as designed, and the level at which the low fuel level light illuminated was 15 percent or 17.7 gallons, which should have provided the pilot slightly more time before flameout than was indicated in the RFM. The quantity indication provided by the fuel quantity gauge was accurate at all levels. Figure 8 shows a photograph of the fuel system component examination setup.

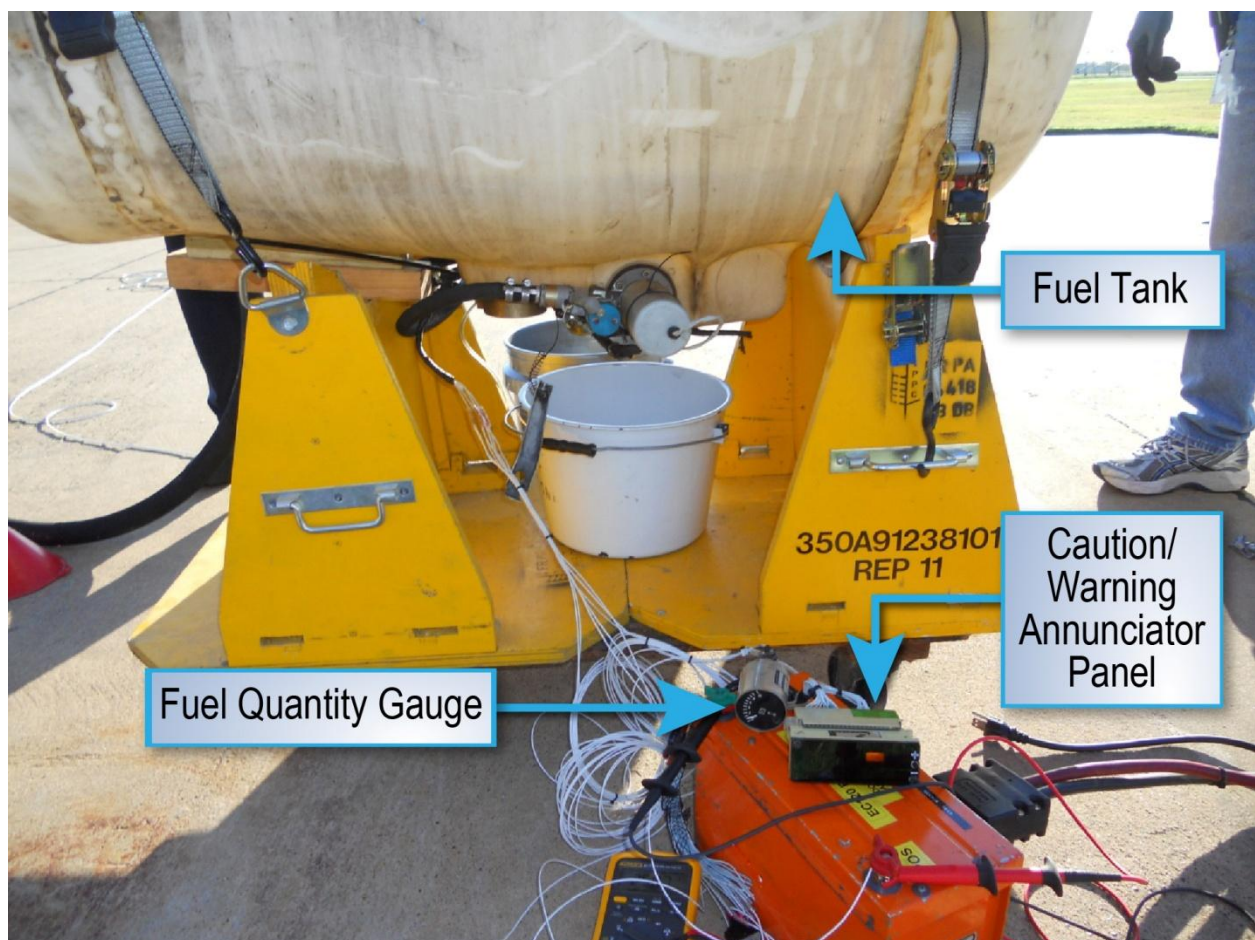

Figure 8. Photograph of the fuel system component examination setup.

An operational check of the caution/warning annunciator panel was performed and revealed that all lights were working properly. Examination of the individual light bulb filaments revealed that the filaments for both bulbs from the low fuel level light exhibited slightly stretched coils consistent with the light being illuminated at the time of impact.

The brightness switch on the caution/warning annunciator panel was found on the dim setting at the accident site. During the examination, the panel was illuminated in daylight conditions and observed in both bright and dim settings. With the panel in the dim position, only the low fuel pressure light (the only light that does not convert to the dim setting by design) was conspicuously illuminated. It was not possible to determine whether the panel was switched to the dim setting during the previous NVG training flight and never returned to bright for the accident flight, whether the panel was switched to the dim setting during the accident flight, or whether this setting occurred during impact.

1.5.2 Certification Flight Tests for Controllability Following Engine Failure

The controllability requirements following engine failure for normal-category rotorcraft, such as the Eurocopter AS350 B2, are specified in 14 CFR 27.143(d), which states, in part, the following:

The rotorcraft, after...complete engine failure..., must be controllable over the range of speeds and altitudes for which certification is requested when such power failure occurs with maximum continuous power and critical weight. No corrective action time delay for any condition following power failure may be less than –

- (i) For the cruise condition, one second, or normal pilot reaction time (whichever is greater); and
- (ii) For any other condition, normal pilot reaction time.

FAA Advisory Circular (AC) 27-1B, “Certification of Normal Category Rotorcraft” (FAA 2008a), provides an acceptable method for demonstrating compliance with the regulatory requirements in 14 CFR Part 27. Regarding 14 CFR 27.143(d), the AC states, in part, the following:

The corrective action time delay for the cruise failure should be 1-second or normal pilot reaction time (whichever is greater). Cyclic and directional control motions which are a part of the pilot task of flight path control are normally not subject to the 1-second restriction; however, the delay is always applied to the collective control for the cruise failure. If the aircraft flying qualities and cyclic trim configuration would encourage routine release of the cyclic control to complete other cockpit tasks during cruise flight, consideration should be given to also holding cyclic fixed for the 1-second delay. Although the same philosophy could be extended to the directional controls, the likelihood of the pilot having his feet away from the pedals is much lower, unless the aircraft has a heading hold feature.

Review of reports documenting the flight tests performed by Eurocopter to demonstrate compliance with 14 CFR 27.143(d) revealed that for the Eurocopter AS350 B1,¹⁹ the test at

¹⁹ According to Eurocopter, the AS350 B1 data from this test are applicable to the AS350 B2 because the B1, the B2, and subsequent variants are all equipped with the same main rotor blades.

maximum continuous power in level flight was at an airspeed of 119 knots, close to the 115-knot airspeed estimated for the accident scenario. In this test, following the simulated engine failure, the test pilot immediately applied left pedal, waited about 1 second, applied down collective, and about .5 second later applied aft cyclic. The rotor rpm dropped about 50 rpm, from 394 rpm to a minimum of about 345 rpm about 3 seconds after the simulated engine failure, and then began to increase.

1.5.3 Simulator Flight Evaluations

Simulator demonstrations of autorotations in various profiles were conducted using Eurocopter's full-motion AS350 simulator, certified to FAA level B standards.²⁰ When an unannounced loss of power was initiated about 275 feet agl and 115 knots,²¹ the simultaneous application of down collective and aft cyclic within about 1 to 2 seconds resulted in a successful autorotation entry with an average time of about 25 seconds between the unannounced loss of power and touchdown. In contrast, if these flight control inputs were not made within about 1 to 2 seconds, the helicopter's nose dropped, the rotor rpm decayed rapidly, and the helicopter impacted terrain about 4 to 5 seconds after the unannounced loss of power. It was observed that the simultaneous application of down collective and aft cyclic was required to maintain rotor rpm and execute a successful autorotation.

1.6 Company Information

Air Methods is a commercial on-demand air taxi operator specializing in helicopter emergency medical services (HEMS). The company was established in 1980 in Colorado and currently serves 48 states with nearly 4,000 employees. It is the largest provider of air medical emergency transport services throughout the United States. In 2012, Air Methods flew 158,263 air medical flight hours and conducted 118,068 patient transports.

Over the last 15 years, Air Methods acquired the following HEMS operations: Mercy Air Service (1997), ARCH (2000), Rocky Mountain Holdings (2002), CJ Systems (2007), and Omniflight (2011). Air Methods acquired LifeNet in the Heartland as part of its acquisition of Rocky Mountain Holdings.

Air Methods provides air medical emergency transport services under three separate operating models: the community-based model, the hospital-based model, and the

²⁰ Flight simulators are certified by the FAA at levels A through D, with level D being the highest or most realistic. The FAA allows a level B simulator to be used for training and evaluating the in-flight maneuver "power plant failure – single engine helicopter."

²¹ NTSB investigators estimated that the accident helicopter was at an altitude of about 275 feet agl and an airspeed of about 115 knots when the engine flamed out.

alternative delivery model.²² The St. Joseph base operates as a community-based model in which EMS helicopters and their crews receive flight requests through AirCom in Omaha, Nebraska. AirCom is an EMS communications center staffed with communications specialists, who are not certified aircraft dispatchers. The AirCom communication specialist receives the request for services from the local/state-operated dispatch system, notifies the pilot of the services request, enters the flight plan into the computer system, coordinates the patient transfer with the requesting agency and receiving hospital, and provides flight following services. Once a mission is in progress, the communication specialist communicates with the pilot through the aircraft radios when the helicopter is in flight and through the pilot's company-issued cell phone when the helicopter is on the ground.

When AirCom enters a flight plan into the system, the Air Methods OCC in Englewood, Colorado, is automatically notified via computer. The OCC performs flight monitoring and ongoing risk assessment for all Air Methods' aircraft (regardless of operating model), and a computer system monitors the positions of the aircraft. The OCC can issue advisories/alerts that may include, but are not limited to, flying in the vicinity of marginal or deteriorating weather conditions, temporary flight restrictions, ground proximity, or any other significant occurrences that could become a flight hazard. All alerts are communicated to the pilot or the appropriate communication specialist responsible for flight following. The OCC communicates to Air Methods aircraft through the AirCom communication specialist or through a hands-free satellite communication system (Skyconnect) that is built into the aircraft's instrument panel. The OCC is also responsible for initiating and managing the Air Methods postaccident/incident response plan. An experienced EMS helicopter pilot is always on duty in one of the two OCC workstations as a central contact point for pilots to discuss operational concerns (such as launch decisions due to developing weather).

At the time of the accident, Air Methods had an operational risk assessment program that required the pilot to use a risk assessment matrix when deciding to accept or decline a flight assignment. According to the GOM, the matrix-determined risk category was to be recorded in the daily flight log and reported to AirCom. As shown in figure 9, there were two matrixes: one for day operations and one for night operations.

²² In the community-based model, Air Methods provides the community with the aircraft, pilots, mechanics, medical crew, medical direction, communications, marketing, EMS licensure, and patient billing and collection. In the hospital-based model, the hospital owns the program and provides the medical personnel, medical direction, communications functions, and patient billing and collection, while Air Methods provides aircraft operation and maintenance. In the alternative delivery model, Air Methods receives support from its partner in medical staffing, medical direction, and marketing, and Air Methods provides the aircraft, pilots, mechanics, communications, billing and collections, and EMS licensure.

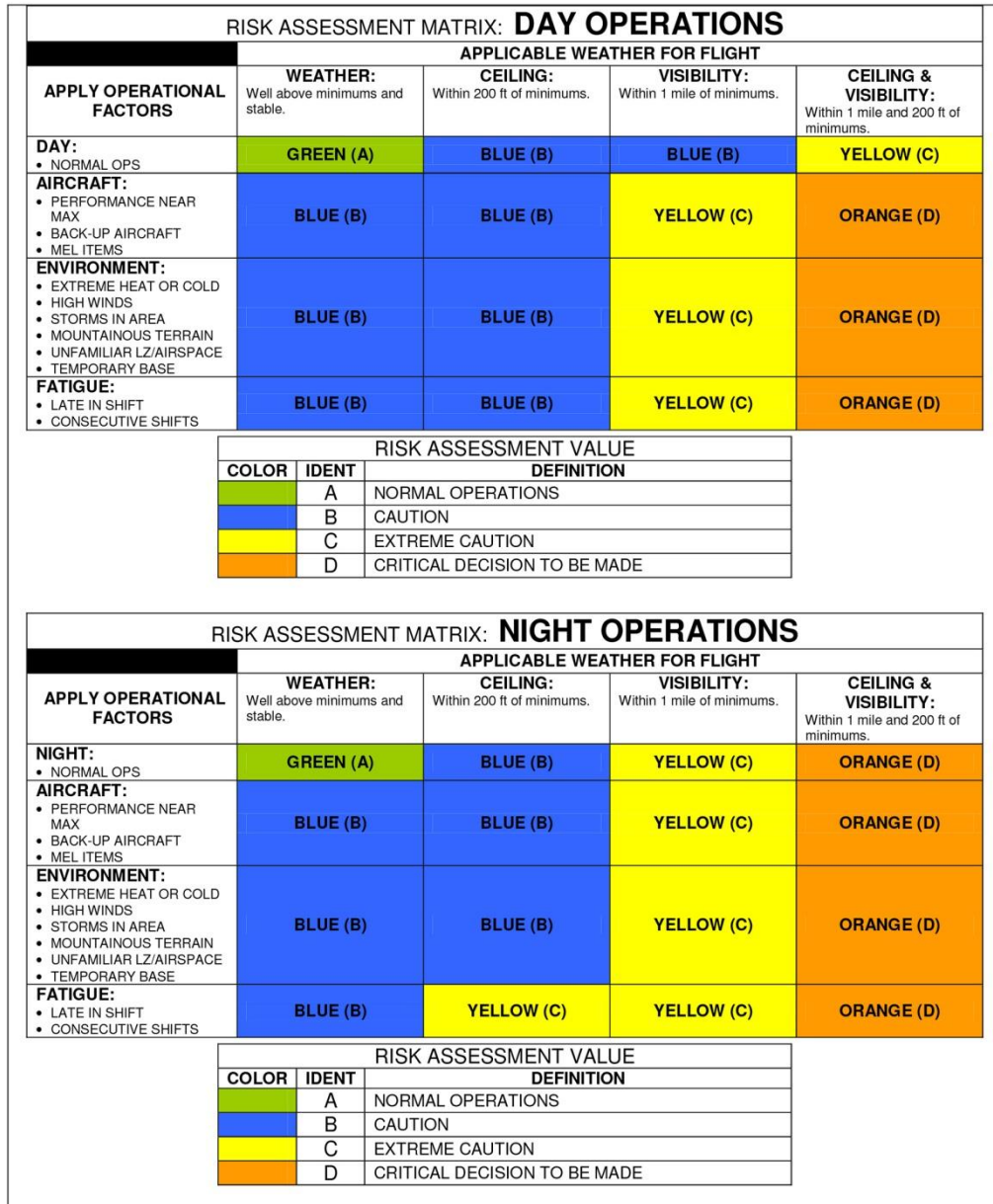

NOTE: The pilot must also consider their (and the medical personnel/crewmembers) experience level with system enhancements (i.e. night vision goggles, autopilot, etc) when performing their risk assessment.

Figure 9. Air Methods flight risk assessment risk matrixes at the time of the accident.

Each matrix identified the categories of risk as green (A-normal operation), blue (B-caution), yellow (C-extreme caution), and orange (D-critical decision to be made). The pilot used weather criteria and cross referenced with aircraft status, environment specifics, and fatigue to determine the risk category. The risk factors listed in the risk assessment matrixes did not include any reference to fuel. The GOM stated that the matrixes “are **not** intended to make the [launch] decision for the pilot and do not list every possible risk factor that may be encountered for a particular flight assignment, but are to be used as **a tool to assist** the pilot in identifying,

assessing, and managing risks.” (Emphasis in the original) The matrixes did not include a risk threshold that triggered mandatory consultation with the OCC or managers, such as the chief pilot.

During both the accident flight and the preceding flight, the pilot reported to AirCom a risk assessment value of blue. Review of the matrix for day operations indicated that the likely reason for the blue value was the applicability of the fatigue risk factor “late in shift.” According to Air Methods operational personnel, a risk assessment value of blue was common.

1.7 Autorotation Guidance

The FAA’s *Helicopter Flying Handbook*, Chapter 2, “Aerodynamics” (FAA 2012a), explains that in normal, powered flight, air is drawn into the main rotor system from above and exhausted downward but, during autorotation, air moves up into the rotor system from below as the helicopter descends. Figure 10, which is included in the handbook, illustrates the difference in airflow.

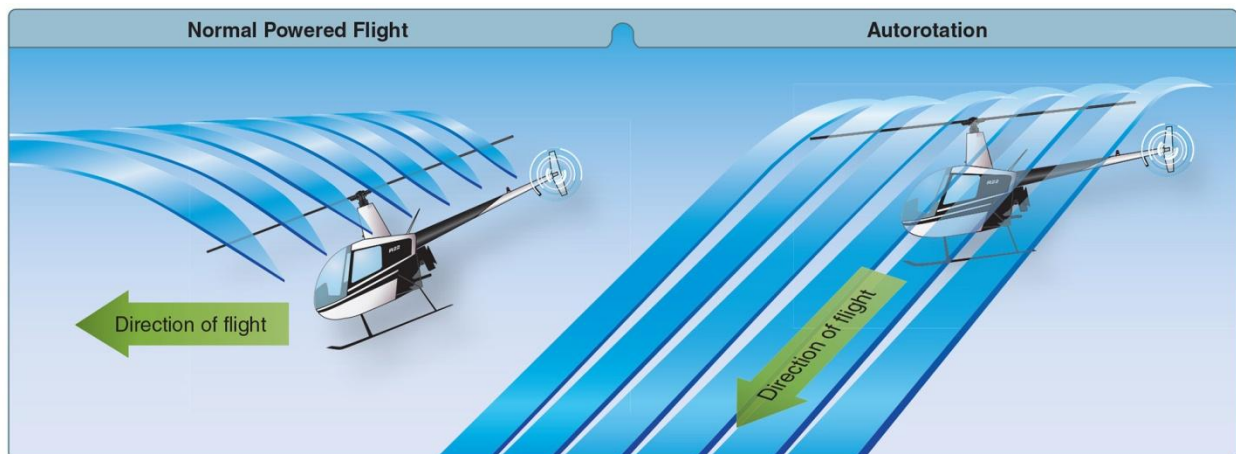

Figure 10. Airflow through the main rotor system during normal, powered flight and during autorotation.

Chapter 2 does not provide any information about how the transition from normal, powered flight to autorotation should be made. Chapter 11, “Helicopter Emergencies,” states that the most common reason for an autorotation is engine failure and provides the following information about how the pilot should react to an engine failure:

At the instant of engine failure, the main rotor blades are producing lift and thrust from their angle of attack...and velocity. By lowering the collective pitch, which must be done immediately in case of an engine failure, lift and drag are reduced, and the helicopter begins an immediate descent, thus producing an upward flow of air through the rotor system. This upward flow of air through the rotor provides sufficient thrust to maintain rotor rpm throughout the descent. Since the tail rotor is driven by the main rotor transmission during autorotation, heading control is maintained with the antitorque pedals as in normal flight.

The handbook does not contain any further information regarding the procedure for entering an autorotative descent.

The FAA's *Helicopter Instructor's Handbook* (FAA 2012b) recommends that to help students better understand autorotation, the instructor should divide it into four distinct phases: entry, steady-state descent, deceleration, and touchdown. Regarding the entry phase, the handbook states, in part, the following:

Guide the student through the entry or first stage of autorotation and explain that this phase is entered after loss of engine power. The loss of engine power and rotor rpm are more pronounced when the helicopter is at high gross weight, high forward speed, or in high density altitude conditions. Any of these conditions demand increased power (high collective position) and a more abrupt reaction to loss of that power. In most helicopters, it takes only seconds for rpm decay to bring rpm to a minimum safe range, requiring a quick collective response from the pilot. The entry into autorotation must be immediate and smooth by lowering the collective, adjusting the pedals for the loss of torque, and adjusting the airspeed for the proper glide angle.

A reprint of the US Army Field Manual 1-51, *Rotary Wing Flight* (Ean 1987), states that autorotations may be divided into three distinct phases: the entry, the steady-state descent, and the deceleration and touchdown. Regarding the entry phase, in addition to information similar to that contained in the FAA's *Helicopter Instructor's Handbook*, the manual states, in part, that "A cyclic flare²³ will help prevent excessive rpm decay if the [engine] failure occurs at high speed. This technique varies with the model helicopter. Pilots should consult and follow the appropriate aircraft Operator's Manual." Because a cyclic flare tilts the main rotor system aft so that the oncoming air is flowing upward through the rotor blades, it rapidly produces the upward flow of air necessary for an autorotation.

²³ A cyclic flare is the use of aft cyclic to increase the helicopter's pitch attitude.

2. Investigation and Analysis

2.1 General

The pilot and the helicopter were properly certified for the 14 CFR Part 135 HEMS flight.

Wreckage examination determined that the helicopter's engine lost power due to fuel exhaustion. Testing also determined that the helicopter's fuel system, including the fuel quantity gauge and the low fuel level light, were operating properly.

2.2 Pilot's Actions During Preflight and Departure for the Hospital

The pilot missed three discrete opportunities to identify that the helicopter had inadequate fuel to complete the assigned mission. First, a preflight inspection was required before departing on the mission. This inspection was normally performed when the pilot first started his shift. However, in the event of a helicopter change-out, the inspection would be performed before the new helicopter was returned to active status. Because no witness observed the pilot performing a preflight inspection of the accident helicopter, it is uncertain whether he performed one. Company procedures for performing a preflight inspection required the pilot to confirm that there was an adequate quantity of fuel on board by turning on the helicopter's master electrical switch and observing the fuel quantity gauge. Postaccident testing showed that the gauge was operating correctly and should have accurately displayed the helicopter's fuel state, about half of the normal 2-hour fuel load, which the pilot should have recognized and corrected. Because the pilot did not recognize the helicopter's low fuel state, he likely performed an incomplete preflight inspection. Additional items indicating that the pilot's preflight inspection was not properly completed were his noncompliance with standard operating procedures that required him to initial the mechanic's CYA entries, sign the daily flight log to confirm completion of the preflight inspection, and take a fuel sample from the helicopter.

The pilot's second missed opportunity was immediately before the flight to Harrison County Community Hospital began when he should have completed the before-takeoff confirmation checklist, which included checking the fuel quantity.²⁴ The pilot's third missed opportunity occurred when his posttakeoff status report made about 1730 required him to report the fuel level to the communication specialist using the gauge in the cockpit²⁵ and he incorrectly reported that he had 2 hours of fuel. It is unlikely that the pilot deliberately misreported the

²⁴ The Air Methods GOM, page B-7/R-5/01-15-11, states, "A before start/before takeoff confirmation checklist will be provided and affixed to each instrument panel in plain view of the pilot. The confirmation checklist will include essential items that will be confirmed by the pilot before each start and takeoff. Prior to start and liftoff each pilot will verbally challenge him or herself and respond verbally to each item on the confirmation checklist to ensure that each item is complete."

²⁵ The Air Methods GOM, page B-14/R-4/11-09-09, states, "When an aircraft lifts off for an assigned flight, the pilot or their designee will provide the communications specialist the number of people on board, fuel load remaining in flight time (hours and minutes), destination, ETA [estimated time of arrival], and risk assessment value."

fuel level because Jet-A fuel was available at the takeoff airport, and the pilot could have had fuel added without difficulty or penalty. It also seems unlikely that the pilot repeatedly misread the gauge indication, especially given the obvious difference in visual indication between the actual level (35 percent) and the reported level (70 percent).

Rather, the pilot's erroneous report can be related to a deviation from the informal refueling practices used at the St. Joseph base. Helicopters at the St. Joseph base were normally refueled to about 70 percent following each mission. However, the accident helicopter was returned after an NVG training flight the previous night with only about 35 percent fuel. Although the pilot had been advised during the shift change briefing about 0630 that the helicopter was low on fuel, it is possible that he forgot about this communication during the intervening 11 hours before the first leg of the mission, in which case he might reasonably have expected the normal 70 percent level for an active helicopter; such an expectation would be consistent with the incorrect fuel status report he provided after takeoff. Also, consistent with what the pilot subsequently stated, he had performed a preflight inspection on the earlier active helicopter (N101LN), and it was fueled to 70 percent. Past NTSB investigations (NTSB 2013) have identified instances in which pilots made callouts without first verifying the cockpit indication that corresponded with the callout. Therefore, it is likely that the pilot reported the fuel he expected to be in the helicopter without effectively referencing the fuel gauge.²⁶ The NTSB concludes that although the helicopter's low fuel state was clearly indicated, the pilot missed three opportunities to detect the condition: (1) before departing on the first leg of the mission as a result of his inadequate preflight inspection, (2) before takeoff by failing to properly complete the before-takeoff confirmation checklist, and (3) after takeoff when he erroneously reported the fuel level.

2.3 Pilot's Decision to Continue the Mission

After reaching Harrison County Community Hospital, the pilot contacted the communication specialist via his company-provided cell phone while waiting for the patient to be loaded into the helicopter, admitted that he had made a mistake and was short of fuel, and requested help locating a nearby fuel option. The pilot did not report and the communication specialist did not ask how much fuel was on board the helicopter. When asked by the communication specialist if he could complete the estimated 34-minute flight to Liberty Hospital before obtaining fuel, the pilot replied that he would probably need to stop en route for fuel. After they determined that the only airport with Jet-A fuel available along the flight route to Liberty Hospital was GPH and estimated that the flight to GPH would be about 2 minutes shorter than the direct flight to Liberty Hospital, the pilot announced his intention to proceed with the mission and to obtain fuel at GPH while en route with the patient on board.

However, the pilot's plan was highly risky because of the limited fuel on board. Further, the plan did not meet minimum fuel requirements for Part 135 operations, which required a minimum of 20 minutes of reserve fuel to launch on a flight. The difference between the actual fuel situation (30 minutes or about 18 percent) and the fuel the pilot reported in his

²⁶ Regarding the posttakeoff report, there is laboratory and operational evidence that pilots can misperceive important information that is plainly visible especially when they have strong conflicting expectations and are engaged in tasks involving selective attention (NTSB 2007).

posttakeoff report (45 minutes or about 26 percent) corresponded to a difference of about one marked increment on the fuel quantity gauge and should have been apparent to the pilot as he waited on the ground and considered his abnormal fuel situation.²⁷ Further, the difference between the actual fuel situation and the minimum fuel required for the trip (52 minutes based on the estimated time en route to GPH of 32 minutes) was even greater. Therefore, the pilot almost certainly knew that he did not have the required fuel reserve and misrepresented his fuel situation in his posttakeoff report because he wanted to give the appearance of compliance with the 20-minute fuel reserve requirement.

The pilot undoubtedly knew that his decision to proceed with the mission was risky, and company personnel uniformly reported that the pilot could have aborted the mission at Harrison County Community Hospital without fear of serious negative consequences from the company. This raises questions about the reasons for the pilot's decision to proceed. The pilot was new to the company and might have been concerned that aborting the mission as a result of an error during preflight preparation would negatively affect others' perceptions of his reliability as an employee. In addition, aborting the mission would likely have involved inconveniences (such as waiting at the hospital for fuel to be delivered) that the pilot probably preferred to avoid. Finally, he might have been influenced by time pressure associated with the urgency of the patient's medical condition and the implications of a delay in treatment. Although the pilot did not express such concerns during any recorded communication, such concerns have played a role in past safety-related incidents involving EMS flights (Connell and Reynard 1995). At the very least, the pilot would have expected that aborting the mission would result in some degree of discomfort for him and the patient. The NTSB concludes that the pilot departed on the second leg of the mission despite knowing that the helicopter had insufficient fuel reserves likely in order to avoid delays and other possible negative outcomes that could have resulted from aborting the mission.

During the accident flight, the pilot was likely monitoring the fuel gauge closely and watching the fuel level decrease. As he approached GPH, the indicated fuel level would have approached zero. This might have prompted the pilot to consider landing the helicopter somewhere off-airport as a precautionary measure. However, by the time the fuel gauge was near zero, the airport was in sight and the pilot was very close to successfully concluding the flight, and he may have been reluctant to land because it would have revealed his noncompliance with the 20-minute fuel reserve requirement. The pilot's decision to continue the flight rather than make a precautionary landing, despite mounting evidence that fuel exhaustion was imminent, was a decision error. The FAA's *Risk Management Handbook* (FAA 2009) calls this type of decision error "get-there-itis" and describes it as an error in which "personal or external pressure clouds the vision and impairs judgment by causing a fixation on the original goal or destination combined with a total disregard for alternative course of action." Human factors researchers (Orasanu, Martin, and Davison 2001), who call this type of error "plan continuation error," have postulated various causes for it and determined that it is more likely to occur near the end of a flight. The NTSB concludes that self-induced pressure likely caused the pilot to fixate on his

²⁷ The fuel quantity gauge, which was readable by turning on the master switch, was marked in increments of 10 percent. A reading of 18 percent would be slightly below the increment representing 20 percent, and a reading of 26 percent would be between the increments representing 20 percent and 30 percent.

intended refueling point and continue the flight rather than make a precautionary landing as the fuel gauge indication approached zero.

2.4 Pilot Human Factors

There was no evidence that the pilot performance deficiencies observed in the accident were common in company operations or consistent with company policy. Rather, the company had formal operational procedures, including the completion of a preflight inspection and use of the before-takeoff checklist that, if complied with, would have led the pilot to detect the helicopter's low fuel level before departing on the first leg of the mission.

The pilot had previously served as a military helicopter pilot, was highly regarded by operational and training personnel at the company as very professional and competent, and had no history of previous violations or training/operational difficulties.

2.4.1 Distraction Due to Text Messaging During Flight and Ground Operations

Personal issues in the pilot's life might have been a source of distraction. His wife was pregnant with their first child, his father had recently undergone cardiac surgery, and he had recently moved to a new city but was still commuting to his old base in St. Joseph. In addition, on the day of the accident, he was making social plans to meet his coworker for dinner after his work shift. During his shift, the pilot needed to focus his attention away from personal issues when performing safety-related tasks, but at such times, both before departure and during the mission, he engaged in personal texting activities.

The mechanic who reconfigured the accident helicopter finished his work and performed a walk-around inspection with the pilot about 1400. The pilot was required to perform a preflight inspection of the helicopter after the mechanic finished reconfiguring the helicopter and before it was returned to service. The helicopter was returned to service about 1530; therefore, the pilot should have performed the preflight inspection sometime between 1400 and 1530. However, as previously discussed, the pilot completed no preflight inspection or performed an incomplete preflight inspection as indicated by his lack of awareness of the helicopter's low fuel state before beginning the mission and the fact that he did not sign off the CYA entries and daily flight log.

According to Air Methods, a preflight inspection of the accident helicopter would have taken 15 or 20 minutes, so the pilot had ample time to perform a complete preflight inspection before the helicopter was returned to service; the pilot's oversight in this area represented noncompliance with company standard operating procedures. Colleagues spoke positively about the pilot's job performance and provided no indication that he was habitually noncompliant; therefore, this oversight seemed out of character for him. It is possible, therefore, that the pilot unintentionally overlooked part or all of the preflight inspection that was required for the helicopter's return to service.

The NTSB examined the pilot's personal cell phone records to see whether distraction caused by the pilot's personal electronic communications could have played a role in his

incomplete preflight inspection. The pilot received frequent text messages between 1406 and 1455, a substantial portion of the time period when the helicopter was being prepared for its return to service. However, the pilot only responded to these texts between 1430 and 1450. Therefore, personal electronic communications did not necessarily preclude the performance of a complete preflight inspection, but they could have distracted the pilot.

The change in helicopters caused a break in routine that could also have played a role in the pilot's incomplete preflight inspection. The disruption caused by the change-out would have required the pilot to think purposefully about the actions that he needed to accomplish, and periodic interruptions of his attention caused by text messaging activity could have resulted in his forgetting about tasks that he had not yet completed. Moreover, the effect of such interruptions on the pilot's memory could have been exacerbated by fatigue, as discussed in section 2.4.2 of this report.

According to a 2000 study of voluntary aviation safety reports, errors of omission make up 44 percent of the errors reported by crewmembers (Sarter and Alexander 2000). Such errors typically result from lapses of attention stemming from the interruption of a task by someone else in the cockpit and the subsequent forgetting of the overlooked action. Such findings have been used to justify the need for sterile cockpit requirements when an aircraft is being operated.²⁸ Further, they suggest that interruptions could also play a role in lapses of attention that occur when safety-critical activities are performed at other times, such as during preflight preparation or predeparture checks.

In this accident, the pilot engaged in nonoperational use of his personal cell phone when the helicopter was being prepared for return to service. Although this activity did not prevent the performance of a thorough preflight inspection, it was a source of distraction that increased the risk of lapses of attention and errors of omission, which did, in fact, occur. Therefore, it is possible that the pilot's nonoperational use of a portable electronic device (PED) contributed to his lack of awareness of the helicopter's abnormally low fuel state.

Company procedures prohibited pilots from using or turning on cell phones during active flight operations.²⁹ The overlay of the pilot's personal cell phone records, however, indicates that he sent one text message during the first leg of the mission and three during the accident flight. Moreover, based on the pilot's report to the communication specialist that he recognized the helicopter's low fuel state about halfway to Harrison County Community Hospital, all of these in-flight messages were sent after the pilot became aware of the helicopter's low fuel state. The last outgoing text was sent about 20 minutes before the accident, and the pilot did not respond to two incoming text messages sent 15 and 11 minutes before the accident. Therefore, there is no evidence that the pilot's airborne texting activities directly affected his response to the engine failure. However, the personal texting activities would have periodically diverted the pilot's attention from flight operations and aeronautical decision-making. At a minimum, the

²⁸ Sterile cockpit requirements are described in 14 CFR 121.542 and 135.100.

²⁹ The Air Methods GOM, page B-7/R-5/01-15-11, states, in part, "In compliance with FCC [Federal Communications Commission] regulations, the PIC shall not allow cellular phones to be used or turned on during ground operations (including taxi and hover operations), takeoff, enroute, approach, and landing. Use of cellular phones while the aircraft is on the ground, not in motion, is acceptable provided it does not interfere with onboard navigation and/or communication equipment."

pilot's attention would be diverted for the amount of time it took to read and compose messages. Further, from a control usage standpoint, to send a text, the pilot would require at least one hand to be temporarily removed from active control of the helicopter.³⁰

Perhaps of equivalent concern, cell phone records indicate that the pilot exchanged an additional three text messages while he was on the ground between flights waiting for the patient to be loaded into the helicopter. As previously stated, the pilot was working with the communication specialist during this period to address the abnormal low fuel situation and needed to make a critical launch decision. Careful attention and conscientious problem solving were needed and should have led him to seek additional operational guidance from the company and to reject the launch due to insufficient fuel. Instead, he devoted a portion of the available time to personal texting.

The pilot's personal texting activities were a source of distractions and interruptions. Distractions and interruptions decrease cognitive capacity, reduce the processing of potentially relevant information, and can cause information in working memory to be confused or forgotten. These effects degrade performance of complex tasks and increase the likelihood of decision errors. Time pressure, which the pilot faced when deciding to continue the mission, can exacerbate this effect by restricting opportunities to weigh potentially relevant cues and consider alternative courses of action (Speier, Vessey, and Valacich 2003). Thus, the pilot's personal texting activities likely degraded his decision-making performance when he decided to continue the mission. The NTSB concludes that the pilot's texting, which occurred (1) while flying, (2) while the helicopter was being prepared for return to service, and (3) during his telephone call to the communication specialist when making his decision to continue the mission, was a self-induced distraction that took his attention away from his primary responsibility to ensure safe flight operations. Further, although there is no evidence that the pilot was texting at the time of the engine failure, his texting while airborne violated the company's cell phone use policy.

Following the accident, Air Methods modified its policy on the use of cell phones.³¹ The new policy states, in part, the following:

In compliance with FAA regulations and to prevent distractions, the PIC shall not allow cellular phones/portable electronic devices to be used or turned on during ground operations including taxi and hover operations, takeoff, enroute, approach, and landing...

In the interest of safety, this is a zero tolerance policy. This includes use of cellular phones and/or electronic tablets for verbal communications, sending or receiving electronic communications such as email, instant messages, or text messages while in flight and aboard an aircraft owned or operated by Air Methods.

³⁰ The helicopter was equipped with a collective friction lock that could be engaged in flight to hold the collective lever in a fixed position and allow temporary removal of the pilot's left hand from the collective in order to perform tasks such as changing radio frequencies and adjusting instruments.

³¹ On December 3, 2012, Air Methods provided a party submission to the NTSB that included a list of its postaccident actions.

Additionally, Air Methods published an article in the August 2012 issue of the company's monthly safety publication, *Safety Connect*, reiterating the company's zero tolerance policy on in-flight cell phone use.

Air Methods postaccident policy explicitly prohibits the use of cell phones and other PEDs in flight. However, this accident shows that the use of PEDs can also create distraction during safety-critical ground activities. Therefore, the NTSB recommends that Air Methods expand its policy on PEDs to prohibit their nonoperational use during safety-critical ground activities, such as flight planning and preflight inspection, as well as in flight.

The NTSB has previously addressed the importance of providing explicit guidance to pilots prohibiting the use of personal PEDs. As a result of the NTSB's investigations of both the October 21, 2009, incident of Northwest Airlines flight 188³² that overflowed its destination of Minneapolis, Minnesota, because the flight crewmembers were distracted, in part, by their use of personal laptop computers and the February 12, 2009, crash of Colgan Air Continental Connection flight 3407 while on approach to Buffalo-Niagara International Airport, Buffalo, New York (NTSB 2010b), on February 23, 2010, the NTSB issued Safety Recommendation A-10-30. This recommendation asked the FAA to "require 14 *Code of Federal Regulations* Part 121, 135, and 91K operators to incorporate explicit guidance to pilots, including checklist reminders as appropriate, prohibiting the use of personal portable electronic devices on the flight deck." On April 26, 2010, the FAA issued Information for Operators (InFO) 10003, "Cockpit Distractions" (FAA 2010), which emphasized that using PEDs was a safety risk. On March 7, 2012, the FAA stated to the NTSB that it did not plan to take any further action because current regulations prohibited the use of PEDs. The FAA believed that issuance of the InFO provided the appropriate information to Part 121, 135, and 91 subpart K operators about these regulations and that checklist reminders were not necessary. On June 14, 2012, the NTSB replied that regulations, as well as company policy, in effect at the time of the Colgan Air Continental Connection flight 3407 accident prohibited the use of PEDs. However, the NTSB noted that InFO 10003 contained no mention of checklist reminders, as specified in the recommendation, and that an InFO is a guidance document, not a regulation. Because the FAA indicated that its actions were complete and that it did not plan to take any additional action, the NTSB classified Safety Recommendation A-10-30 "Closed—Unacceptable Action."

On January 15, 2013, the FAA issued a notice of proposed rulemaking (NPRM), "Prohibition on Personal Use of Electronic Devices on the Flight Deck" (*Federal Register* 2013, 2912), that proposed a requirement to prohibit flight crewmembers in Part 121 operations from using a personal wireless communications device or laptop computer for personal use while at their duty station on the flight deck while the aircraft is being operated. The NPRM stated that the prohibition would commence at "taxi (movement of the aircraft under its own power)" and end when "the aircraft is parked at the gate at the end of the flight segment."

In its comments on the NPRM submitted to the FAA on March 12, 2013, the NTSB stated that it was pleased with the FAA's proposed rulemaking. However, the NTSB indicated that contrary to the broad scope of Safety Recommendation A-10-30, the proposed rule would

³² More information about this incident, NTSB case number DCA10IA001, is available online at <http://www.nts.gov/aviationquery/index.aspx>.

only affect pilots operating under 14 CFR Part 121. The NTSB noted that pilots using PEDs while operating under Parts 135 and 91 subpart K are equally susceptible to the potentially catastrophic consequences of distraction, and their passengers are all placed at risk. The NTSB indicated that it believes that the FAA should expand the proposed rule to Part 135 and 91 subpart K operations to more broadly and effectively address this issue within the industry.

This accident clearly demonstrates that expansion of the FAA's proposed rule on PED use to 14 CFR Part 135 and 91 subpart K operations is warranted. Therefore, the NTSB recommends that the FAA prohibit flight crewmembers in 14 CFR Part 135 and 91 subpart K operations from using a PED for nonoperational use while at their duty station on the flight deck while the aircraft is being operated. Further, because this accident shows that nonoperational use of PEDs can be a distraction during safety-critical, not-in-motion ground operations, the NTSB recommends that the FAA require all 14 CFR Part 121, 135, and 91 subpart K operators to incorporate into their initial and recurrent pilot training programs information on the detrimental effects that distraction due to the nonoperational use of PEDs can have on performance of safety-critical ground and flight operations. Also, the NTSB recommends that the FAA require all 14 CFR Part 121, 135, and 91 subpart K operators to review their respective GOMs to ensure that procedures are in place that prohibit the nonoperational use of PEDs by operational personnel while in flight and during safety-critical preparatory and planning activities on the ground in advance of flight.

2.4.2 Fatigue

Fatigue was evaluated as a potential factor in degrading the pilot's performance. On the night before the accident, records indicated that the pilot participated in a telephone call that ended about 0019. Therefore, the pilot was active past his preferred bedtime of 2200 to 2300, and, assuming he woke up about 0530 (1 hour before his shift started), his uninterrupted sleep potential was likely limited to no more than about 5 hours. According to a 2003 study of performance degradation due to sleep restriction, 3 hours of sleep loss (5 hours obtained) in one night is sufficient to degrade vigilance performance and increase reaction time (Belenky and others 2003). On the morning of the accident, the pilot stated in a telephone conversation that he did not sleep well and felt tired. Evidence indicates that the pilot was active all day with limited opportunity for rest.³³ He had been on duty about 12 hours at the time of the accident, a duration associated with increased cockpit errors (Goode 2003), and awake more than 13 hours, a threshold also associated with increased errors (Dawson and Reid 1997). Further, the pilot needed to complete the preflight inspection of the helicopter between 1400 and 1530, and research indicates that due to circadian and other factors, the midafternoon period can be associated with reduced levels of alertness.

Fatigue degrades decisions involving unexpected situations or plan revision and decreases the ability to deal with distractions and communicate effectively (Harrison and Horne 2000). Effects of fatigue on performance include increased lapses (errors of omission), increased perseveration on ineffective solutions, and increased reaction times (Dinges 1996). The pilot

³³ According to the cell phone records, calls were made from the pilot's cell phone about 0811, 0822, 0841, 0901, 1112, 1204, 1330, and 1552. Text messages were sent from the pilot's cell phone about 0853-0857, 0922-1057, 1130, 1147-1158, 1356, 1430-1450, 1621-1635, 1655, 1719-1722, 1746, and 1802-1822.

clearly demonstrated performance deficits in two areas: errors of omission (neglecting to refuel the helicopter and check the fuel gauge before departure) and perseveration on ineffective solutions (continuing the mission after discovering he had insufficient fuel). Additionally, he may have displayed increased reaction time when responding to the loss of engine power; however, this could not be confirmed because the lack of a recording device precluded determination of the timing of the pilot's control inputs. The pilot's demonstrated performance deficiencies were consistent with known effects of fatigue. Further, interviews with coworkers indicated that such deficiencies were uncharacteristic of his performance. The NTSB concludes that because of restricted sleep the night before the accident, the timing of his operational activities, and the nature of the pilot's errors, which were uncharacteristic of his performance, the pilot was experiencing fatigue, which likely degraded his performance.

The fact that the pilot reported for duty and completed his shift despite not sleeping well and feeling fatigued raises concern about the policies and training Air Methods used to combat the effects of fatigue on pilot performance and safety in the company's flight operations. The company's GOM (page B-15/R-5/01-15-11) states that pilots were expected to "report for duty with the appropriate rest and be capable of performing the functions of a flight crewmember," but it did not contain a policy describing what pilots should do if they had been unable to obtain adequate rest or felt fatigued. However, the company provided training on causes of fatigue, performance-related effects of fatigue, and fatigue countermeasures during initial and recurrent pilot ground training. The company also provided rest facilities at its pilot bases and encouraged pilots to nap during their work shift if they felt tired. In addition, the lead pilot at the company's St. Joseph base said that he had turned down a flight due to fatigue on one occasion and company managers had been accepting of his decision. Further, the company included fatigue risk factors in the risk assessment matrixes used by its pilots when deciding to accept or decline a flight assignment.

As of March 22, 2013, federal regulations require flight crewmembers operating under 14 CFR Part 135 to complete initial crew resource management (CRM) training, and operators are required to have a CRM training program with both initial and recurrent training modules. These modules must contain material addressing the effects of fatigue on performance, fatigue avoidance strategies, and fatigue countermeasures. Although Air Methods did not address fatigue-related issues in detail in its CRM training provided to pilots at the time of the accident, it did cover this information in other training modules. Thus, because Air Methods was already covering much, if not all, of the required material, the company will likely be able to comply with the new training requirement through slight reorganizations of its training program.

The pilot had completed the Air Methods initial pilot training program and had therefore been exposed to the company's fatigue-related training material. Presumably, he was familiar with the effects of fatigue on performance, fatigue avoidance strategies, and fatigue countermeasures. He did not have the benefit of a clear company policy encouraging him to go off-duty if he felt fatigued. However, company pilots and other personnel indicated that the company was supportive of safety-oriented decisions and that pilots were unlikely to be questioned if they occasionally turned down a flight due to fatigue. Therefore, although the company's policies could be improved, it appears that the pilot had received appropriate training on fatigue-related issues and that he did not accept the accident flight while fatigued because of pressure from company managers.

The NTSB has previously addressed the need for operator policies allowing crewmembers to decline flying assignments due to fatigue by issuing Safety Recommendations A-08-19 and -20, which asked the FAA to do the following:

In cooperation with pilot unions, the Regional Airline Association, and the Air Transport Association, develop a specific, standardized policy for 14 *Code of Federal Regulations* Part 121, 135, and Part 91 subpart K operators that would allow flight crewmembers to decline assignments or remove themselves from duty if they were impaired by a lack of sleep. (A-08-19)

Once the fatigue policy described in Safety Recommendation A-08-19 has been developed, require 14 *Code of Federal Regulations* Part 121, 135, and Part 91 subpart K operators to adopt this policy and provide, in writing, details of the policy to their flight crewmembers, including the administrative implications of fatigue calls. (A-08-20)

On March 14, 2011, the NTSB classified Safety Recommendations A-08-19 and -20 “Open—Acceptable Response” based on the FAA’s September 14, 2010, publication of an NPRM, “Flightcrew Member Duty and Rest Requirements,” addressing flight crew fatigue in Part 121 operations. On November 15, 2010, in comments submitted about this NPRM, the NTSB stated that the NPRM proposed requirements that would enable a flight crewmember to self-report as too fatigued to continue working an assigned flight duty period and prohibit a certificate holder from allowing the flight crewmember to continue. The NTSB stated that, if adopted, this would likely satisfy the intent of Safety Recommendations A-08-19 and -20 for Part 121 operations, but the FAA needed to adopt similar requirements for Part 135 and Part 91 subpart K operators. In the NPRM, the FAA indicated that the Part 135 community should expect an NPRM and final rule that are very similar, if not identical, to those proposed for Part 121 operators. On January 4, 2012, the FAA issued a final rule based on this NPRM. This accident provides an example of a fatal accident demonstrating the need for a similar requirement for Part 135 operations.

2.5 Lack of Operational Control Center Involvement in Decision-Making

Company communication specialists provided dispatch services to pilots but were not qualified to provide operational guidance. Company individuals qualified to provide operational guidance, such as representatives of the OCC or managers such as the chief pilot, were available but were not contacted by the communication specialist or the pilot. If an operationally qualified individual had been involved in the decision-making process that led to the departure from Harrison County Community Hospital with insufficient fuel reserves, such an individual likely would have asked the accident pilot how much fuel was on board the helicopter, understood that there was not sufficient fuel on board to meet minimum fuel requirements, and proposed delaying or canceling the mission and having fuel brought to the helicopter.

At the time of the accident, the company communication specialists had guidance to contact the OCC for certain operational issues, but these issues did not include fuel-related issues

and unplanned deviations. Following the accident, Air Methods added these items to the list of issues requiring immediate notification of the OCC. Additionally, Air Methods developed a procedure and provided training to its communication specialists on how to recognize potential elevated risk situations and when to contact the OCC.

The OCC was staffed at all times with at least one specialist with HEMS operational experience who was available as a central contact point for pilots to discuss operational concerns, such as launch decisions due to developing weather. However, the OCC did not share responsibility for “go/no go” decisions, which were solely the responsibility of the PIC,³⁴ and the risk assessment matrixes used by pilots at the time of the accident did not include a risk threshold that triggered mandatory consultation with the OCC. Pilots interviewed after the accident stated that they rarely contacted the OCC to discuss operational issues. This practice was evident in the accident when the pilot told the communication specialist about his low fuel situation but did not contact the OCC.

Following the accident, Air Methods revised its risk assessment program by replacing its risk assessment matrix with a risk assessment tool used by the pilot to calculate a numerical risk assessment value at the beginning of each shift and then update it before beginning each flight leg. Depending on the numerical value, the risk is categorized as “Low/Med,” “High,” or “Ex High.” The instructions for the risk assessment tool indicate that High and Ex High risk values must be mitigated by the pilot to a Low/Med value. The tool includes a specific risk factor for fuel. However, there is still no risk threshold that triggers mandatory OCC consultation. Rather, the instructions state, “If the PIC cannot mitigate a High or Ex High risk to an acceptable level for flight acceptance, then the PIC might consider conferring with either the OCC or with their Regional Management structure in an attempt to gain assistance in finding mitigators to a lower risk threshold.”

The NTSB is encouraged that Air Methods has revised the list of specific items that trigger the communication specialist to involve the OCC and has provided training on identifying elevated risk situations to its communication specialists. However, the NTSB is concerned that it is not standard practice for pilots to contact the OCC for help with operational decision-making and that Air Methods’ new risk assessment matrix does not include a risk threshold that triggers mandatory OCC consultation.

By contrast, both the FAA and the NTSB have emphasized the importance in air medical operations of having someone who is operationally qualified and outside the immediate situation provide an independent judgment on the safety of a launch. For example, in its 2006 *Special Investigation Report on Emergency Medical Services Operations* (NTSB 2006c), the NTSB noted that its investigations of EMS accidents revealed that “many EMS operators lack a consistent, comprehensive flight dispatch procedure, which—as part of a flight risk evaluation program—would help EMS pilots determine whether it is safe to accept or continue a mission.” Further, the NTSB stated that a flight dispatcher (not the 911 or hospital dispatcher) “would be less susceptible to making flight decisions based on the urgency of the situation and would be able to obtain an overall perspective of the mission’s safety.” As a

³⁴ The Air Methods GOM, page A-20/R-5/01-15-11, states that the PIC has “final authority for the safety of passengers, cargo, and medical personnel, and has operational control for all flights which they initiate.”

result, on February 7, 2006, the NTSB issued Safety Recommendation A-06-14, which asked the FAA to “require emergency medical services operators to use formalized dispatch and flight-following procedures that include up-to-date weather information and assistance in flight risk assessment decisions.”

In May 2008, the FAA published AC 120-96, “Integration of Operations Control Centers into Helicopter Emergency Medical Services Operations” (FAA 2008b), which provided detailed guidance about the creation and operation of OCCs for HEMS operations. In the AC, the FAA noted that “the main concept of OCCs and flight dispatch procedures is joint mission responsibility...[which] requires that at least one qualified ground staff member, in addition to the PIC, be responsible for monitoring factors affecting mission and flight status.” Further, the FAA specified that the OCC specialist should maintain awareness of all operational considerations including “weather, communication, fuel, [and] landing zone.”

On October 12, 2010, the FAA issued an NPRM on air ambulance and commercial helicopter operations (*Federal Register* 2010, 62639) that included a proposed requirement to mandate the creation of an OCC and the use of operations control specialists for HEMS operations. On January 10, 2011, the NTSB submitted comments to the FAA on the NPRM, noting that the NPRM partially addressed Safety Recommendation A-06-14 by proposing that commercial HEMS operators with 10 or more helicopters that are engaged in HEMS activities establish OCCs. However, the NTSB indicated that it believes the requirement for an OCC should be applied to all HEMS operators. The NTSB stated that “The vast majority of HEMS accidents have historically involved poor decision-making by various personnel involved in launching or conducting a HEMS flight. Having [operational control specialists] who are trained and available to help manage the HEMS launch and in-flight decision-making will help pilots recognize and avoid high-risk situations.”

Further, the NTSB noted that while it supports the FAA’s proposal to require HEMS operators to implement preflight risk assessment programs, a preflight risk assessment is only one part of the overall risk reduction process and that it “cannot substitute for the services and support provided by an OCC.” On August 22, 2012, the NTSB classified Safety Recommendation A-06-14 “Open—Acceptable Response,” pending the issuance of a final rule mandating OCCs for HEMS operators.

This accident exemplifies the need for OCC involvement in operational decision-making. An operationally qualified individual outside the immediate situation would likely have recognized that the pilot’s decision to continue the mission was inappropriate. Although Air Methods was proactive in establishing its OCC, the OCC did not share responsibility for launch and in-flight decisions, and there were no procedures specifying that the OCC should be notified of abnormal fuel situations. The NTSB concludes that because there was no policy requiring that the Air Methods OCC be notified of abnormal fuel situations, available operationally qualified personnel outside the situation who would likely have recognized the pilot’s decision to continue the mission as inappropriate were not consulted. Therefore, the NTSB recommends that Air Methods revise company procedures so that pilots are no longer solely responsible for nonroutine operational decisions but are required to consult with the Air Methods OCC for approval to accept or continue a mission when confronted with elevated risk situations, such as fuel-related issues and unplanned deviations. Further, because the NTSB

believes that a joint mission responsibility shared between the pilot and an OCC specialist would enhance the safety of HEMS flight operations, the NTSB reiterates Safety Recommendation A-06-14.

2.6 Autorotation Guidance and Training

2.6.1 Loss of Engine Power and Autorotation Entry

The pilot's awareness of the helicopter's low fuel status and the near zero indication on the fuel gauge as the flight continued should have given the pilot ample warning of the impending engine failure and provided him with the opportunity to prepare to execute an autorotation.³⁵ However, it was evident from the helicopter's impact in a 40° nose-down attitude, on a heading nearly opposite to the direction of travel, at a high rate of descent, and with a low rotor rpm that the pilot did not successfully execute an autorotation following the loss of engine power.

The simulator flight evaluations conducted during the investigation demonstrated that from low level cruise flight (the accident flight condition at the time of the engine flameout), it was possible to maintain rotor rpm and execute a successful autorotation with touchdown occurring about 25 seconds after engine failure. However, a successful autorotation was only possible if simultaneous flight control inputs of down collective and aft cyclic were made within about 1 to 2 seconds after the engine failure. If these flight control inputs were not promptly made, the result was a rapid decay in rotor rpm and impact with terrain in a nose-down attitude in an average time of 4 to 5 seconds after the simulated engine failure. Because the helicopter was not equipped with any type of recording device, it was not possible to determine the pilot's control inputs following the loss of engine power. However, the consistency between the impact geometry and signatures and the simulator profile produced when simultaneous aft cyclic and down collective were not input indicates that the pilot either delayed too long in making control inputs or responded with flight control inputs other than simultaneous aft cyclic and down collective. The NTSB concludes that although a successful autorotation was possible, the pilot failed to make the flight control inputs necessary to enter an autorotation when the engine lost power, which resulted in a rapid decay in rotor rpm and impact with terrain.

The pilot was required to demonstrate competency in performing autorotations during his Part 135 required initial and recurrent training, which took place 10 and 5 months before the accident, respectively. According to other Air Methods pilots, the practice autorotations that they performed in flight training were done at airspeeds of about 80 knots. This was consistent with traditional flight training for autorotations, which has typically been done at airspeeds below cruise and has emphasized immediate lowering of the collective as the first pilot action in response to a loss of engine power. However, Eurocopter AS350 B1 certification flight test data suggest that following a simulated engine failure at cruise speeds comparable to the accident scenario, the pilot may need to make a substantial aft cyclic input within 1.5 seconds of engine failure to achieve a successful autorotation entry.

³⁵ Additionally, the low fuel level light likely came on at least 18 minutes before the engine flamed out; however, because the brightness switch for the caution/warning panel was found in the dim position and it is unknown when the switch was placed in that position, it is possible that the pilot may not have seen the light.

Further, the simulator flight evaluations showed that following a simulated engine failure at 115 knots, the helicopter tended to pitch down rapidly, requiring immediate use of aft cyclic to enter the autorotation and avoid an unrecoverable decay in rotor rpm. Pilots might not be able to initiate the appropriate flight control inputs (aggressive aft cyclic, down collective, and left antitorque pedal) within such a short period of time unless they have received extensive practice in similar flight conditions. The pilot's autorotation training had involved lower speeds in the vicinity of 80 knots where less aft cyclic is needed to enter an autorotation, so the practice autorotations he performed had been less dependent on immediate, coordinated application of aft cyclic and down collective. Thus, the pilot's autorotation training was not representative of an actual engine failure at cruise speed and did not optimally prepare him to respond appropriately to such a scenario.

An additional difference between the pilot's autorotation training and the actual engine failure was that the pilot received all of his Air Methods training in Eurocopter AS350 B2 helicopters, and because the Eurocopter AS350 B2's floor-mounted fuel control lever (throttle) does not have an idle detent, Air Methods elected to conduct practice autorotations with no reduction in throttle.³⁶ A practice autorotation with no throttle reduction differs significantly from an actual engine failure because in an actual engine failure, there are distinct symptoms or cues, including a jerk in the yaw axis and a drop in rotor rpm, that will not occur during a practice autorotation with no throttle reduction. These cues should alert the pilot to immediately enter an autorotation. It is unlikely that the pilot had previous exposure to these cues because his only autorotation training in Eurocopter AS350-series helicopters was that provided by Air Methods. It is possible that if the pilot had previous exposure to these cues, it might have facilitated a more rapid recognition of the loss of engine power during the accident flight.

Because it did not provide practice in entering autorotations from cruise airspeeds or the opportunity to experience the symptoms of an engine failure, the NTSB concludes that the autorotation training that the pilot received in the Eurocopter AS350 B2 was not representative of an actual engine failure at cruise airspeed and likely contributed to the pilot's failure to execute a successful autorotation.

2.6.2 Inadequate Guidance on Autorotation Entry Procedures

When the pilot received his training in the Eurocopter AS350 B2, the Air Methods Pilot Training Program, Annex 1, AS350 Flight Training Maneuvers Manual listed "smooth, positive reduction" of the collective to the full down position as the first step in performing a practice autorotation. This was consistent with the emergency procedure in the AS350 B2 RFM, which states that the pilot's first action in response to an engine failure should be to lower the collective. Also, the training program was consistent with the general guidance provided by the FAA in the *Helicopter Flying Handbook* and the *Helicopter Instructor's Handbook*, which emphasizes lowering the collective to initiate an autorotation.

Following the accident, Air Methods changed the guidance on autorotations in its Eurocopter AS350 pilot training program to emphasize the importance of applying simultaneous

³⁶ Not all Eurocopter AS350-series helicopters are equipped with a fuel flow control lever. The Eurocopter AS350 B3 model helicopter is equipped with a twist-grip style throttle on the collective flight control.

control inputs when entering an autorotation. The changes included adding a discussion of autorotations to the AS350 Flight Training Maneuvers Handbook that states, in part, “It is imperative that the pilot take immediate action to change to an autorotative attitude; i.e., simultaneously applying aft cyclic, lowering the collective to maintain rotor rpm, and trimming the aircraft. Failure to apply aft cyclic while lowering the collective will result in a nose low attitude; this condition may be unrecoverable at low altitudes.”

Also, a note was added to the procedure in the Air Methods AS350 Flight Training Maneuvers Handbook for performing practice autorotations stating that initial cyclic, collective, and antitorque pedal adjustments “must occur simultaneously to preclude an excessively nose low attitude from developing that may be unrecoverable at low altitude.” Additionally, the first step in performing a practice autorotation was changed to “Cyclic: Adjust to maintain 65 knots,” followed by lowering the collective as the second step.

The NTSB recognizes that the motions of a helicopter following an engine power loss vary greatly from one make and model helicopter to another and from one flight condition to the next. Therefore, the technique required for safely entering an autorotation will vary, and there is no technique of universal applicability. However, in discussions with experienced helicopter flight instructors and test pilots, NTSB investigators found agreement that simultaneous control inputs, as opposed to only lowering the collective, should be used when entering an autorotation and that the critical task when entering an autorotation is to establish airflow upward through the main rotor system. Further, the instructors and test pilots interviewed reported that the Eurocopter AS350 B2 is not unique in requiring simultaneous application of aft cyclic and down collective to safely enter an autorotation at cruise airspeeds; rather this technique is applicable to many, if not all, helicopters with low inertia rotor systems.³⁷

As illustrated in figure 10, a helicopter is not in an autorotation until the airflow is passing upward through the rotor blades. Pilots are taught to lower the collective following an engine failure because it results in a descent that produces an upward flow of air. However, when a helicopter is in cruise flight at the time the engine fails, using aft cyclic to increase the pitch attitude (a cyclic flare) will more rapidly produce an upward flow of air because it tilts the main rotor system aft so that the oncoming air is flowing upward through the rotor blades. As noted in *Rotary Wing Flight* (Ean 1987), this cyclic flare will help prevent excessive rotor rpm decay, which is critical in helicopters with low inertia rotor systems because they lose rotor rpm very quickly.

The NTSB believes that the additional information about autorotation entries provided by Air Methods to its AS350 pilots would be equally valuable to all pilots flying helicopters with low inertia rotor systems. The NTSB concludes that without specific guidance regarding the appropriate control inputs for entering an autorotation at cruise airspeeds, the pilots of helicopters with low inertia rotor systems may not be aware that aft cyclic must be applied when collective is lowered to maintain control of the helicopter and perform a successful autorotation. Therefore, the NTSB recommends that the FAA inform pilots of helicopters with low inertia

³⁷ Rotor inertia is a measure of the amount of energy stored in a helicopter’s main rotor system. Following an engine failure, a low rotor inertia system will lose rpm faster than one with high inertia because it has relatively less stored energy. High inertia rotor systems typically have heavy, long blades, whereas low inertia rotor systems have light, short blades.

rotor systems about the circumstances of this accident, particularly emphasizing the findings of the simulator flight evaluations, and advise them of the importance of simultaneously applying aft cyclic and down collective to achieve a successful autorotation entry at cruise airspeeds.

The NTSB's review of the guidance on performing autorotations in the FAA's *Helicopter Flying Handbook*, which is the primary source of information on helicopter aerodynamics and flight maneuvers published by the FAA, found that it emphasizes lowering the collective as the initial step in entering an autorotation, does not address the use of simultaneous control inputs in response to an engine failure, and contains minimal information on the entry phase of autorotations. The NTSB is concerned by this lack of information because, as this accident demonstrates, if the entry is not performed correctly, an unrecoverable loss of rotor rpm can occur. The handbook does not inform pilots that the rate of rotor rpm decay following an engine failure is most rapid when the helicopter is at high gross weight, high forward speed, or in high density altitude conditions and that in the most severe cases, it takes only seconds for the decay to become unrecoverable. The handbook also does not inform pilots that the procedure for safely entering an autorotation varies with the flight condition and the make and model helicopter or note that when entering an autorotation at cruise airspeed, aft cyclic can help prevent excessive rotor rpm decay.

The NTSB notes that some information about the entry phase of an autorotation is included in the FAA's *Helicopter Instructor's Handbook*. However, this publication is targeted at flight instructors and may not be read by helicopter pilots who are not instructors or training to become an instructor. Also, the FAA's *Helicopter Instructor's Handbook* does not point out that the procedure for safely entering an autorotation varies with the make and model helicopter or note that when entering an autorotation at cruise airspeed, aft cyclic can help prevent excessive rotor rpm decay.

The NTSB believes that because the *Helicopter Flying Handbook*, which is the primary source of information on helicopter aerodynamics and flight maneuvers published by the FAA, lacks a thorough discussion on the entry phase of autorotations, helicopter pilots may believe that lowering the collective (with no other control inputs) will always result in a successful autorotation entry. The NTSB concludes that because of the lack of information about the entry phase of autorotations in the FAA's *Helicopter Flying Handbook*, helicopter pilots may not be aware that there are flight conditions in which immediate and simultaneous control inputs, not only lowering collective, are required to enter an autorotation. Therefore, the NTSB recommends that the FAA revise the *Helicopter Flying Handbook* to include a discussion of the entry phase of autorotations that explains the factors affecting rotor rpm decay and informs pilots that immediate and simultaneous control inputs may be required to enter an autorotation.

2.6.3 Need for Simulator Training of Helicopter Emergency Medical Services Pilots

Air Methods is now providing all of its Eurocopter AS350 pilots with autorotation training and line-oriented flight training in a full-motion Eurocopter AS350 flight simulator. The NTSB notes that use of a flight simulator addresses the lack of practice representative of an actual engine failure at cruise airspeed in the accident pilot's autorotation training because

engine failures in a simulator are representative of an actual engine flameout and can be induced unexpectedly in any flight condition.

This accident highlights the value of using simulators and flight training devices (FTD) for helicopter pilot training. The availability of new helicopter FTDs and simulators has increased greatly over the past few years.³⁸ In addition to enabling pilots to train in skills that are too risky to perform in a real helicopter, such as the low altitude engine failure in this accident, simulators and FTDs can be used day or night and in any kind of weather, unlike real helicopters. Simulators and FTDs can also allow training for a complete flight, including an emergency, increasing the likelihood that a pilot will respond correctly and quickly in an emergency. Further, simulated flights can be tailored to a specific type of flight operation, such as interfacility HEMS flights (hospital to hospital) and remote helispot landings and takeoffs.

The NTSB has previously addressed the need for HEMS pilots to receive scenario-based simulator training. On September 24, 2009, the NTSB issued Safety Recommendations A-09-87 and -88, which asked the FAA to do the following:

Develop criteria for scenario-based helicopter emergency medical services (HEMS) pilot training that includes inadvertent flight into instrument meteorological conditions and hazards unique to HEMS operations, and determine how frequently this training is required to ensure proficiency. (A-09-87)

Once the actions recommended in Safety Recommendation A-09-87 are completed, require helicopter emergency medical services pilots to undergo periodic FAA-approved scenario-based simulator training, including training that makes use of simulators or flight training devices. (A-09-88)

On October 7, 2010, the NTSB classified Safety Recommendations A-09-87 and -88 “Open—Acceptable Response” based on the FAA’s response that it would conduct a study of the feasibility and safety impacts of requiring HEMS operators to conduct training in simulators.

The FAA’s October 2010 NPRM on air ambulance and commercial helicopter operations did not address Safety Recommendations A-09-87 and -88. In its comments on the NPRM, the NTSB stated that it “strongly believes that the increased use of helicopter simulators for HEMS pilot training is essential to improving pilot knowledge and skills for inadvertent IMC [instrument meteorological condition] encounters and other piloting issues, such as emergency procedures. The NTSB encourages the FAA to consider including guidance for the use of simulators for helicopter pilot training in the final rule.” On August 22, 2012, the NTSB classified Safety Recommendation A-09-87 “Open—Unacceptable Response” pending completion of the recommended action.

³⁸ According to a June 2010 article in *Rotor & Wing* magazine, FTDs are now available for the Eurocopter AS350 B2/B3, Eurocopter EC135, Bell 206, Bell 407, and Bell 427 helicopters. The highest level FTDs, level 7, allow flight crewmembers to receive the maximum amount of training credit from an FTD and qualify for nearly all parts of a Part 135 check ride (Adams 2010).

This accident again demonstrates the importance of using helicopter simulators for HEMS pilot training. Because engine failures can be induced unexpectedly in any flight condition in a simulator and a simulator can accurately replicate the symptoms of an actual engine flameout, the NTSB concludes that if the pilot had received autorotation training in a simulator rather than in a helicopter, he would have been better prepared and might have effectively responded to the engine failure during the accident flight. Air Methods has already implemented scenario-based simulator training for its pilots, and the NTSB continues to believe that all HEMS pilots should receive this type of training. Therefore, the NTSB reiterates Safety Recommendations A-09-87 and -88 and reclassifies A-09-88 “Open—Unacceptable Response.”

2.7 Lack of Flight Recorder

As previously noted, because the helicopter was not equipped with any type of recording device, the pilot’s control inputs in response to the loss of engine power are unknown. Also, the helicopter’s motions (pitch, bank, and yaw attitudes) and the time history of the rotor rpm decay following the loss of engine power are unknown. Further, although radar data and satellite tracking system data were available to NTSB investigators to determine the altitude and flightpath of the helicopter, the radar data and the tracking system data ended about 50 and 30 seconds, respectively, before the accident occurred. Thus, the NTSB could only estimate the helicopter’s altitude and airspeed at the time the engine flameout occurred. In addition, recorded images would possibly have shown where the pilot’s attention was directed immediately before the engine flameout and the setting of the brightness switch on the caution/warning annunciator panel during the accident flight. The NTSB concludes that if a recorder system that captured cockpit audio, images, and parametric data had been installed, it would have enabled NTSB investigators to reconstruct the final moments of the accident flight and determine why the pilot did not successfully enter an autorotation.

The NTSB notes that the helicopter was not required to have any type of crash-resistant recorder installed. Previous NTSB recommendations have addressed the need for recording information on aircraft such as the one involved in this accident. Specifically, as a result of the NTSB’s investigation of the July 27, 2007, fatal accident involving two Eurocopter AS350 B2 electronic news gathering helicopters that collided in flight in Phoenix, Arizona (NTSB 2009b), on February 9, 2009, the NTSB issued Safety Recommendations A-09-9 through -11 to the FAA. These recommendations proposed the required installation of crash-resistant recorders capable of audio, video, and data recording, as specified in European Organization for Civil Aviation Equipment (EUROCAE) document ED-155,³⁹ in both newly manufactured and existing turbine-powered, nonexperimental, nonrestricted-category aircraft. On June 11, 2012, the NTSB classified Safety Recommendations A-09-9 through -11 “Closed—Unacceptable Action” because the FAA stated that it did not intend to mandate the equipage of additional recording systems on all turbine-powered, nonexperimental, nonrestricted-category aircraft because of significant costs and limited ability to assess benefits.

³⁹ EUROCAE ED-155 is a manufacturing standard, issued in July 2009, for a lightweight, low-cost, robust aircraft recording device. The ED-155 standard covers flight data recorder-like data recording, cockpit voice recorder-like audio recording, cockpit video, and data-like message recording. It also specifies parameters that should be recorded for both airplanes and helicopters and the details of range, resolution, and accuracy that should be required.

Specific to HEMS operations, the NTSB also issued Safety Recommendation A-09-90, which asked the FAA to “require helicopter emergency medical services operators to install flight data recording devices and establish a structured flight data monitoring program that reviews all available data sources to identify deviations from established norms and procedures and other potential safety issues.” In its October 2010 NPRM on air ambulance and commercial helicopter operations, the FAA stated that it was considering requiring certificate holders conducting helicopter air ambulance operations to install lightweight aircraft recording systems (LARS) in their helicopters. However, the requirement for such a device was not incorporated into the proposed rule. On July 18, 2012, the NTSB classified Safety Recommendation A-09-90 “Open—Unacceptable Response,” pending the FAA’s issuance of a requirement to install LARS in helicopters used for EMS operations.

On November 15, 2010, the FAA published Technical Standard Order (TSO) C197, “Information Collection and Monitoring Systems,” which provides standards for the design and production certification of lightweight recording systems. The TSO invokes certain requirements of the EUROCAE ED-155 standard. In addition to being a valuable aid to accident investigation, a TSO C197-compliant recorder would also be fully capable of supporting a structured flight data monitoring program, whether it is implemented as a formal FAA-approved flight operations quality assurance program or a monitoring program that is part of a company safety management system.

The benefits of data monitoring programs have been evaluated and documented for commercial airlines. The U.S. Government Accountability Office (GAO 1998) conducted an evaluation of airline-based data collection and monitoring programs in 1998, shortly after adoption of such programs. The evaluation highlighted that such programs provide enhanced safety as well as financial benefits due to increased efficiency of operations. It is likely that the HEMS community, as well as all commercial helicopters, will experience similar benefits.

Since 2010, Eurocopter has been delivering new AS350 B3 helicopters with Appareo Vision 1000 devices installed. The Appareo Vision 1000 is a cockpit imaging and flight data monitoring device installed in over 350 aircraft being operated in the United States, with about 250 new Eurocopter AS350s registered and operating in the US fleet.⁴⁰ About 10 percent of Air Method’s fleet now has Appareo devices installed. Air Methods is currently developing a flight data monitoring program that will use the information recorded in these devices. While the NTSB is encouraged by the voluntary installation and use of these devices, the NTSB is concerned that these devices are installed in only a small portion of the overall US fleet and that they currently do not meet the minimum performance and crash survivability standards specified in TSO C197.

Although issuance of TSO C197 constitutes progress, the NTSB is concerned that the FAA has not mandated the equipage of TSO-approved lightweight recording systems for all turbine-powered aircraft. This accident is another of the numerous accidents that the NTSB has investigated where the lack of recorders made the full information necessary to analyze an accident difficult or impossible to obtain (NTSB 2011a, 2011b, 2010a, 2009a, 2006a, 2006b, and 2003).

⁴⁰ Appareo indicated that it is manufacturing and selling about 350 new units each year worldwide.

Further, recorders can help investigators identify safety issues that may not otherwise be detectable, which is critical to the prevention of future accidents. For example, the August 10, 2005, accident involving a Sikorsky S-76C+ helicopter that crashed into the Baltic Sea shortly after takeoff from Tallinn, Estonia, was the first time that the NTSB participated in a helicopter accident investigation in which a flight data recorder (FDR) was on board.⁴¹ Importantly, without the recorder data, investigators would not have been able to identify the airworthiness issue that resulted in NTSB's issuance of three urgent safety recommendations (A-05-33 through -35) on November 17, 2005. In response to Safety Recommendations A-05-33 and -34, the FAA issued Special Airworthiness Information Bulletin SW-06-15, which was followed by Airworthiness Directive 2010-10-02, and these recommendations were classified "Closed—Acceptable Alternate Action" on May 25, 2011. In response to Safety Recommendation A-05-35, the FAA issued two Safety Alerts for Operators (06021 and 08015), and this recommendation was classified "Closed—Acceptable Action" on January 5, 2009. Similarly, a Cessna 208B that crashed on November 19, 2005, following a loss of control in icing conditions during descent for landing in Moscow, Russia, was one of the first Cessna 208B airplanes to be equipped with a cockpit voice recorder (CVR) and an FDR.⁴² The recorder data provided investigators with new insight into the effects of icing on the Cessna 208B's performance and resulted in the NTSB's issuance of three urgent safety recommendations (A-06-01 through -03) on January 17, 2006. In response, the FAA issued Airworthiness Directive 2006-06-06, which fully met the intent of the recommendations, and all three recommendations were classified "Closed—Acceptable Action" on November 15, 2006.

The recorder data from these two accidents were critical to identifying urgent safety issues, which clearly demonstrates that recording devices on aircraft can have a significant impact on safety. Therefore, the NTSB recommends that the FAA require the installation of a crash-resistant flight recorder system on all newly manufactured turbine-powered, nonexperimental, nonrestricted-category aircraft that are not equipped with an FDR and a CVR and are operating under 14 CFR Parts 91, 121, or 135. The crash-resistant flight recorder system should record cockpit audio and images with a view of the cockpit environment to include as much of the outside view as possible, and parametric data per aircraft and system installation, all as specified in TSO C197, "Information Collection and Monitoring Systems." Further, the NTSB recommends that the FAA require all existing turbine-powered, nonexperimental, nonrestricted-category aircraft that are not equipped with an FDR or CVR and are operating under 14 CFR Parts 91, 121, or 135 to be retrofitted with a crash-resistant flight recorder system. The crash-resistant flight recorder system should record cockpit audio and images with a view of the cockpit environment to include as much of the outside view as possible, and parametric data per aircraft and system installation, all as specified in TSO C197, "Information Collection and Monitoring Systems."

⁴¹ This accident was investigated by the Aircraft Accident Investigation Commission of Estonia, and the NTSB participated in the investigation under the provisions of Annex 13 to the International Convention on Civil Aviation.

⁴² This accident was investigated by the Interstate Aviation Commission of Russia, and the NTSB participated in the investigation under the provisions of Annex 13 to the International Convention on Civil Aviation.

3. Conclusions

3.1 Findings

1. The pilot and the helicopter were properly certified for the 14 *Code of Federal Regulations* Part 135 helicopter emergency medical services flight.
2. Wreckage examination determined that the helicopter's engine lost power due to fuel exhaustion. Testing also determined that the helicopter's fuel system, including the fuel quantity gauge and the low fuel level light, were operating properly.
3. Although the helicopter's low fuel state was clearly indicated, the pilot missed three opportunities to detect the condition: (1) before departing on the first leg of the mission as a result of his inadequate preflight inspection, (2) before takeoff by failing to properly complete the before-takeoff confirmation checklist, and (3) after takeoff when he erroneously reported the fuel level.
4. The pilot departed on the second leg of the mission despite knowing that the helicopter had insufficient fuel reserves likely in order to avoid delays and other possible negative outcomes that could have resulted from aborting the mission.
5. Self-induced pressure likely caused the pilot to fixate on his intended refueling point and continue the flight rather than make a precautionary landing as the fuel gauge indication approached zero.
6. The pilot's texting, which occurred (1) while flying, (2) while the helicopter was being prepared for return to service, and (3) during his telephone call to the communication specialist when making his decision to continue the mission, was a self-induced distraction that took his attention away from his primary responsibility to ensure safe flight operations. Further, although there is no evidence that the pilot was texting at the time of the engine failure, his texting while airborne violated the company's cell phone use policy.
7. Because of restricted sleep the night before the accident, the timing of his operational activities, and the nature of the pilot's errors, which were uncharacteristic of his performance, the pilot was experiencing fatigue, which likely degraded his performance.
8. Because there was no policy requiring that the Air Methods Operational Control Center be notified of abnormal fuel situations, available operationally qualified personnel outside the situation who would likely have recognized the pilot's decision to continue the mission as inappropriate were not consulted.
9. Although a successful autorotation was possible, the pilot failed to make the flight control inputs necessary to enter an autorotation when the engine lost power, which resulted in a rapid decay in rotor rpm and impact with terrain.

10. The autorotation training that the pilot received in the Eurocopter AS350 B2 was not representative of an actual engine failure at cruise airspeed and likely contributed to the pilot's failure to execute a successful autorotation.
11. Without specific guidance regarding the appropriate control inputs for entering an autorotation at cruise airspeeds, the pilots of helicopters with low inertia rotor systems may not be aware that aft cyclic must be applied when collective is lowered to maintain control of the helicopter and perform a successful autorotation.
12. Because of the lack of information about the entry phase of autorotations in the Federal Aviation Administration's *Helicopter Flying Handbook*, helicopter pilots may not be aware that there are flight conditions in which immediate and simultaneous control inputs, not only lowering collective, are required to enter an autorotation.
13. If the pilot had received autorotation training in a simulator rather than in a helicopter, he would have been better prepared and might have effectively responded to the engine failure during the accident flight.
14. If a recorder system that captured cockpit audio, images, and parametric data had been installed, it would have enabled National Transportation Safety Board investigators to reconstruct the final moments of the accident flight and determine why the pilot did not successfully enter an autorotation.

3.2 Probable Cause

The National Transportation Safety Board determines that the probable causes of this accident were the pilot's failure to confirm that the helicopter had adequate fuel on board to complete the mission before making the first departure, his improper decision to continue the mission and make a second departure after he became aware of a critically low fuel level, and his failure to successfully enter an autorotation when the engine lost power due to fuel exhaustion. Contributing to the accident were (1) the pilot's distracted attention due to personal texting during safety-critical ground and flight operations, (2) his degraded performance due to fatigue, (3) the operator's lack of a policy requiring that an operational control center specialist be notified of abnormal fuel situations, and (4) the lack of practice representative of an actual engine failure at cruise airspeed in the pilot's autorotation training in the accident make and model helicopter.

4. Recommendations

4.1 New Recommendations

As a result of this investigation, the National Transportation Safety Board makes the following safety recommendations:

To the Federal Aviation Administration:

Prohibit flight crewmembers in 14 *Code of Federal Regulations* Part 135 and 91 subpart K operations from using a portable electronic device for nonoperational use while at their duty station on the flight deck while the aircraft is being operated. (A-13-7)

Require all 14 *Code of Federal Regulations* Part 121, 135, and 91 subpart K operators to incorporate into their initial and recurrent pilot training programs information on the detrimental effects that distraction due to the nonoperational use of portable electronic devices can have on performance of safety-critical ground and flight operations. (A-13-8)

Require all 14 *Code of Federal Regulations* Part 121, 135, and 91 subpart K operators to review their respective general operations manuals to ensure that procedures are in place that prohibit the nonoperational use of portable electronic devices by operational personnel while in flight and during safety-critical preparatory and planning activities on the ground in advance of flight. (A-13-9)

Inform pilots of helicopters with low inertia rotor systems about the circumstances of this accident, particularly emphasizing the findings of the simulator flight evaluations, and advise them of the importance of simultaneously applying aft cyclic and down collective to achieve a successful autorotation entry at cruise airspeeds. (A-13-10)

Revise the *Helicopter Flying Handbook* to include a discussion of the entry phase of autorotations that explains the factors affecting rotor rpm decay and informs pilots that immediate and simultaneous control inputs may be required to enter an autorotation. (A-13-11)

Require the installation of a crash-resistant flight recorder system on all newly manufactured turbine-powered, nonexperimental, nonrestricted-category aircraft that are not equipped with a flight data recorder and a cockpit voice recorder and are operating under 14 *Code of Federal Regulations* Parts 91, 121, or 135. The crash-resistant flight recorder system should record cockpit audio and images with a view of the cockpit environment to include as much of the outside view as possible, and parametric data per aircraft and system installation, all as specified in Technical Standard Order C197, "Information Collection and Monitoring Systems." (A-13-12)

Require all existing turbine-powered, nonexperimental, nonrestricted-category aircraft that are not equipped with a flight data recorder or cockpit voice recorder and are operating under 14 *Code of Federal Regulations* Parts 91, 121, or 135 to be retrofitted with a crash-resistant flight recorder system. The crash-resistant flight recorder system should record cockpit audio and images with a view of the cockpit environment to include as much of the outside view as possible, and parametric data per aircraft and system installation, all as specified in Technical Standard Order C197, “Information Collection and Monitoring Systems.” (A-13-13)

To Air Methods Corporation:

Expand your policy on portable electronic devices to prohibit their nonoperational use during safety-critical ground activities, such as flight planning and preflight inspection, as well as in flight. (A-13-14)

Revise company procedures so that pilots are no longer solely responsible for nonroutine operational decisions but are required to consult with the Air Methods Operational Control Center for approval to accept or continue a mission when confronted with elevated risk situations, such as fuel-related issues and unplanned deviations. (A-13-15)

4.2 Previously Issued Recommendations Reiterated in This Report

The National Transportation Safety Board reiterates the following safety recommendations to the Federal Aviation Administration:

Require emergency medical services operators to use formalized dispatch and flight-following procedures that include up-to-date weather information and assistance in flight risk assessment decisions. (A-06-14 classified “Open—Acceptable Response”)

Develop criteria for scenario-based helicopter emergency medical services (HEMS) pilot training that includes inadvertent flight into instrument meteorological conditions and hazards unique to HEMS operations, and determine how frequently this training is required to ensure proficiency. (A-09-87 classified “Open—Unacceptable Response”)

4.3 Previously Issued Recommendation Reiterated and Reclassified in This Report

The National Transportation Safety Board reiterates and reclassifies from “Open—Acceptable Response” to “Open—Unacceptable Response” the following safety recommendation to the Federal Aviation Administration:

Once the actions recommended in Safety Recommendation A-09-87 are completed, require helicopter emergency medical services pilots to undergo periodic FAA-approved scenario-based simulator training, including training that makes use of simulators or flight training devices. (A-09-88)

BY THE NATIONAL TRANSPORTATION SAFETY BOARD

DEBORAH A.P. HERSMAN
Chairman

ROBERT L. SUMWALT
Member

CHRISTOPHER A. HART
Vice Chairman

MARK R. ROSEKIND
Member

EARL F. WEENER
Member

Adopted: April 9, 2013

Chairman Hersman filed the following concurring statement on April 17, 2013; Member Sumwalt filed the following concurring statement on April 10, 2013; and Member Weener filed the following concurring and dissenting statement on April 15, 2013.

Board Member Statements

Chairman Deborah A.P. Hersman, concurring:

Decision making is about making the right choices. In Advisory Circular 60-22, the FAA defines Aeronautical Decision Making or ADM as a *systemic approach to the mental process of evaluating a given set of circumstances and determining the best course of action*. Whether using the 3 P model (Perceive, Process, and Perform), the DECIDE model, or reviewing AOPA's Air Safety Foundation publication titled, "Do the Right Thing: Decision Making for Pilots" – a key part of ADM is eliminating or mitigating risks.

Our role in accidents is to identify what our investigators found. Through our efforts we bring issues to the attention of the transportation community so changes can be made to improve safety. In this investigation we identified a pilot who did not put his safety, the safety of his crew and the safety of his patient first. He did not eliminate and mitigate the risks that were right in front of him.

We have all made bad choices, but most of the time those decisions don't result in the loss of life. The choices that pilots make preparing for flight and in-flight are critical. Some increase safety margins, some decrease safety margins. HEMS flights have been identified as higher risk operations – that is why it is hard to understand why a generally good pilot did not have the discipline to do the right thing. There is a time and a place for everything. Our recommendations and safety alert recognize that the flight deck is not the time or the place to use PEDs for non-operational uses.

Members Sumwalt and Rosekind joined in this statement.

Member Robert L. Sumwalt, concurring:

I believe this investigation uncovered many important issues – issues that, if addressed, will improve aviation safety.

One key issue emerging from this investigation concerns the criticality of proper pilot actions during autorotation entries. As discussed in Sections 1.5.3 and 2.6, when entering an autorotation at cruise speeds, the pilot must simultaneously apply aft cyclic and down collective. As stated in Section 2.6 of the report:

The simulator flight evaluations conducted during the investigation demonstrated that from low level cruise flight (the accident flight condition at the time of the engine flameout), it was possible to maintain rotor rpm and execute a successful autorotation with touchdown occurring about 25 seconds after engine failure. However, a successful autorotation was only possible if simultaneous flight control inputs of down collective and aft cyclic were made within about 1 to 2 seconds after the engine failure. If these control inputs were not promptly made, the result was a rapid decay in rotor rpm and impact with terrain in a nose-down attitude in an average time of 4 to 5 seconds after the simulated engine failure.

Findings 11 and 12 of this report, and Recommendations 4 and 5 further discuss and address this issue.

The reason for this concurring statement is that while I support the above report language that emphasizes the criticality of applying aft cyclic while flying at higher airspeeds, there are some flight regimes where the pilot would need to apply *forward* cyclic. According to page 9 of Eurocopter's submission to Bureau d'Enquêtes et d'Analyses and NTSB, dated December 3, 2012:

The simulator demonstrations confirmed the well-known fact that airspeed and attitude are two significant factors that affect how the pilot should appropriately respond with cyclic inputs when faced with a loss of engine power. For example, a pilot who is flying at a very low airspeed, when faced with a loss of power, would need to initially lower collective pitch (to maintain NR) and push the cyclic forward to establish 65 kts in accordance with the autorotation procedure, whereas a pilot flying at a very high airspeed with a nose down attitude would be required to lower collective pitch and pull aft cyclic when faced with a loss of power to establish 65 kts in accordance with the autorotation procedure.

In summary, I support and applaud the excellent work of the NTSB's investigative staff. However, I was concerned that the report's emphasis on the critical need to pull aft cyclic during an autorotation entry while at cruise airspeeds may have overshadowed that, in some circumstances such as slower airspeeds, it may be necessary to apply a forward cyclic input.

Herein lies one major advantage of high fidelity simulator training, where pilots can learn and apply appropriate flight control inputs during autorotation entries in all flight regimes.

Member Weener joined in this statement.

Member Earl F. Weener, concurring and dissenting:

Generally, I agree with the findings from the investigation and the final report on this accident, a crash following loss of engine power due to fuel exhaustion. However, I do not support the part of the Probable Cause statement, or the various statements in the report and conclusions, attributing causal aspects of the accident to the pilot's use of a personal electronic device. I am unconvinced the investigation or final report provides sufficient evidence to draw these conclusions. Instead, the investigation uncovered a clear case of poor aeronautical decision-making, one of the primary causes of GA accidents. Further, by emphasizing the PED distraction theme, the report itself provides a distraction from other critical safety issues identified and supported by the investigation, namely: appropriate involvement of independent, operationally qualified personnel in decision-making; adequate guidance on autorotation entry procedures; helicopter simulator training; and the importance of flight recording devices. Consistent with this view, I also oppose the issuance of a safety alert concerning non-operational use of PEDs based on this accident and the others cited in the alert.

To be clear, I am not endorsing the pilot's actions with regard to use of his PED. However, as discussed at the Board meeting, the PED was only one of many distractions for this pilot that day. As ill advisable and disconcerting as his actions may be with regard to his PED use, the report fails to make the case for attributing the causes or contributing causes of this accident to distraction based explicitly on use of the device. The pilot's flawed aeronautical decision-making is the fundamental issue – which goes well beyond his decisions regarding cell phone use. It is the root cause of this accident, and in order to effect change the root cause must be addressed. At multiple, distinct points, the pilot demonstrated poor judgment by proceeding with the mission: (1) he did not complete a proper preflight inspection; (2) prior to departing on the first leg of the mission, he failed to complete the before take-off confirmation checklist; (3) en route, upon re-discovering the low fuel level, he reported an erroneous fuel level; (4) rather than abort the mission on landing at the hospital, he chose to load the patient and attempt another landing to refuel with the patient on board, 2 minutes short of the destination hospital; and finally, (5) en route to the refueling port, he chose to exhaust the fuel supply rather than attempt an emergency landing. These decisions were unrelated to his use of a PED. This is not to say he was not coping with distractions, and likely multiple distractions based on the record, but we can clearly say the act of texting or using the PED did not interfere or affect these decisions. Once the pilot made his decision to proceed with this mission, nothing was going to deter him from his course – regardless of whether he used a cell phone or not. If distraction is to be an identified causal factor, as discussed at the Board meeting, there is no basis to single out the PED as the lone distraction. This approach of calling out PED use in this case establishes a new, and unwarranted, standard for PED distraction, rather than addressing the issue of distraction as a whole.

Unfortunately, in the aftermath of the report's adoption, the unintended consequence of the Board's emphasis on PEDs is the de-emphasis now on the other safety critical aspects of this accident. This accident brought into sharp focus the importance of proper instruction and training for rotorcraft operations, and in particular, realistic training achieved through use of simulators as well as training for emergency events. I commend the staff's effort to delve into and highlight the autorotation dynamics and the importance of simulator training. Such issues are of significant relevance to helicopter operations, especially HEMS operations. As well, the report sections

pertaining to the involvement of operationally qualified personnel, who can assess situations with independent judgment, is well founded. The report discussion on this issue is particularly relevant because it provides an opportunity for the Board to reiterate its position on the subject, and to clarify for the community what is intended by previous Board recommendations. Although Air Methods took the step to employ dispatch services and staff an operational control center with qualified personnel, it did not sufficiently establish OCC involvement in operational decision-making – a direct step toward mitigating poor aeronautical decision-making. Finally, the accident provides yet another reminder of the need for data recording devices, albeit the need was well documented through previous Board actions. Recording devices on aircraft have a proven track record for improving safety, a fundamental goal of the Board, although not seen as interesting as PEDs.

The Board's ability to enhance transportation safety rests solely on its credibility, credibility based on independent and objective analyses. It has a responsibility to ensure the elements of a report are fully supported by the facts and circumstances from the underlying accident investigation. As I am constantly reminded within the agency, the Board does not engage in speculation. The value of Board reports and for that matter, safety alerts, is undermined or lost if the underlying facts and analyses do not support the conclusions. In this report, as well as the safety alert, I believe the Board has not fulfilled its responsibility in terms of attributing a contributing cause of this accident to the pilot's PED use.

This accident was certainly a tragedy that need not occur. As the lead advocate for GA safety, I have seen like circumstances far too often in the accident statistics: loss of life due to poor aeronautical decision-making. Addressing this causal factor, along with the other critical safety issues identified through this investigation as outlined above, provides the greatest potential to enhance the safety of helicopter operations. Sadly, this potential is now limited by the distraction caused from the pilot's use of a PED.

References

- Adams, Charlotte. 2010. "Simulation & Training." *Rotor & Wing* (June). http://www.aviationtoday.com/rw/training/maintenance/Simulation-and-Training_68236.html.
- Belenky, Gregory, Nancy J. Wesensten, David R. Thorne, Maria L. Thomas, Helen C. Sing, Daniel P. Redmond, Michael B. Russo, and Thomas J. Balkin. 2003. "Patterns of Performance Degradation and Restoration During Sleep Restriction and Subsequent Recovery: A Sleep Dose-Response Study." *Journal of Sleep Research* 12(1): 1-12.
- Connell, Linda J. and William D. Reynard. 1995. "Incident Reports Highlight Hazards in EMS Helicopter Operations." *Helicopter Safety*. Arlington, VA: Flight Safety Foundation.
- Dawson, Drew and Kathryn Reid. 1997. "Fatigue, Alcohol and Performance Impairment." *Nature* 388: 235.
- Dinges, David. 1996. "Performance Effects of Fatigue." In *Fatigue Symposium Proceedings, November 1-2, 1995*. Washington, DC: NTSB.
- Ean, Nicholas. 1987. *Rotary Wing Flight: An Edited Reprint of Selected Portions of the U.S. Army Field Manual 1-51*. Renton, WA: Aviation Supplies & Academics, Inc.
- FAA (Federal Aviation Administration). 2012a. *Helicopter Flying Handbook*. FAA-H-8083-21A. Washington, DC: US Department of Transportation, FAA. http://www.faa.gov/regulations_policies/handbooks_manuals/aircraft/media/faq-h-8083-21A.pdf.
- . 2012b. *Helicopter Instructor's Handbook*. FAA-H-8083-4. Washington, DC: US Department of Transportation, FAA. http://www.faa.gov/regulations_policies/handbooks_manuals/aviation/media/FAA-H-8083-4.pdf.
- . 2010. "Cockpit Distractions." InFO 10003. Washington, DC: US Department of Transportation, FAA. http://www.faa.gov/other_visit/aviation_industry/airline_operators/airline_safety/info/all_infos/media/2010/InFO10003.pdf.
- . 2009. *Risk Management Handbook*. FAA-H-8083-2. Washington, DC: US Department of Transportation, FAA. http://www.faa.gov/regulations_policies/handbooks_manuals/aviation/media/faq-h-8083-2.pdf.
- . 2008a. "Certification of Normal Category Rotorcraft." AC 27-1B. Washington, DC: US Department of Transportation, FAA. http://www.faa.gov/documentlibrary/media/ advisory_circular/AC%2027-1B%20CHG3.pdf.

----. 2008b. "Integration of Operations Control Centers into Helicopter Emergency Medical Services Operations." AC 120-96. Washington, DC: US Department of Transportation, FAA. [http://rgl.faa.gov/Regulatory_and_Guidance_Library/rgAdvisoryCircular.nsf/list/AC%20120-96/\\$FILE/AC%20120-96.pdf](http://rgl.faa.gov/Regulatory_and_Guidance_Library/rgAdvisoryCircular.nsf/list/AC%20120-96/$FILE/AC%20120-96.pdf).

Federal Register. 2013. Vol. 78, no. 10 (January 15).

Federal Register. 2010. Vol. 75, no. 196 (October 12).

GAO (U.S. Government Accountability Office). 1998. *Aviation Safety, U.S. Efforts to Implement Flight Operations Quality Programs*. GAO/RCED-98-10. Washington, DC: GAO.

Goode, Jeffrey H. 2003. "Are Pilots at Risk of Accidents Due to Fatigue?" *Journal of Safety Research* 34: 309-313.

Harrison, Yvonne and James A. Horne. 2000. "The Impact of Sleep Deprivation on Decision Making: A Review." *Journal of Experimental Psychology: Applied* 6(3): 236-249.

NTSB (National Transportation Safety Board). 2013. "Preventing Rote Callouts." Safety Alert SA-018. Washington, DC: NTSB. http://www.nts.gov/doclib/safetyalerts/SA_018.pdf.

----. 2011a. *Loss of Control While Maneuvering, Pilatus PC-12/45, N128CM, Butte, Montana, March 22, 2009*. Aircraft Accident Report AAR-11/05. Washington, DC: NTSB. <http://www.nts.gov/doclib/reports/2011/AAR1105.pdf>.

----. 2011b. *Collision into Mountainous Terrain, GCI Communications Corp., de Havilland DHC-3T, N455A, Aleknagik, Alaska, August 9, 2010*. Aircraft Accident Report AAR-11/03. Washington, DC: NTSB. <http://www.nts.gov/doclib/reports/2011/AAR1103.pdf>.

----. 2010a. *Crash During Takeoff of Carson Helicopters, Inc., Firefighting Helicopter Under Contract to the U.S. Forest Service, Sikorsky S-61N, N612AZ, Near Weaverville, California, August 5, 2008*. Aircraft Accident Report AAR-10/06. Washington, DC: NTSB. <http://www.nts.gov/doclib/reports/2010/AAR1006.pdf>.

----. 2010b. *Loss of Control on Approach, Colgan Air, Inc., Operating as Continental Connection Flight 3407, Bombardier DHC-8-400, N200WQ, Clarence Center, New York, February 12, 2009*. Aircraft Accident Report AAR-10/01. Washington, DC: NTSB. <http://www.nts.gov/doclib/reports/2010/AAR1001.pdf>.

----. 2009a. *Crash During Approach to Landing of Maryland State Police Aerospatiale SA365N1, N92MD, District Heights, Maryland, September 27, 2008*. Aircraft Accident Report AAR-09/07. Washington, DC: NTSB. <http://www.nts.gov/doclib/reports/2009/AAR0907.pdf>.

- . 2009b. *Midair Collision of Electronic News Gathering Helicopters, KTVK-TV, Eurocopter AS350B2, N613TV, and U.S. Helicopters, Inc., Eurocopter AS350B2, N215TV, Phoenix, Arizona, July 27, 2007.* Aircraft Accident Report AAR-09/02. Washington, DC: NTSB. <http://www.nts.gov/doclib/reports/2009/AAR0902.pdf>.
- . 2007. *Attempted Takeoff from Wrong Runway, Comair Flight 5191, Bombardier CL-600-2B19, N431CA, Lexington, Kentucky, August 27, 2006.* Aircraft Accident Report AAR-07/05. Washington, DC: NTSB. <http://www.nts.gov/doclib/reports/2007/AAR0705.pdf>.
- . 2006a. *Controlled Flight Into Terrain, Era Aviation, Sikorsky S-76A++, N579EH, Gulf of Mexico, About 70 Nautical Miles South-Southeast of Scholes International Airport, Galveston, Texas, March 23, 2004.* Aircraft Accident Report AAR-06/02. Washington, DC: NTSB. <http://www.nts.gov/doclib/reports/2006/AAR0602.pdf>.
- . 2006b. *Controlled Flight Into Terrain, Beech King Air 200, N501RH, Stuart, Virginia, October 24, 2004.* Aircraft Accident Brief AAB-06/01. Washington, DC: NTSB. <http://www.nts.gov/doclib/reports/2006/AAB0601.pdf>.
- . 2006c. *Special Investigation Report on Emergency Medical Services Operations.* NTSB/SIR-06/01. Washington, DC: NTSB. <http://www.nts.gov/doclib/safetystudies/SIR0601.pdf>.
- . 2003. *Loss of Control and Impact With Terrain, Aviation Charter, Inc., Raytheon (Beechcraft) King Air A100, N41BE, Eveleth, Minnesota, October 25, 2002.* Aircraft Accident Report AAR-03/03. Washington, DC: NTSB. <http://www.nts.gov/doclib/reports/2003/AAR0303.pdf>
- Orasanu, Judith, L. Martin, and Jeannie Davison. 2001. "Cognitive and Contextual Factors in Aviation Accidents; Decision Errors." In *Linking Expertise and Naturalistic Decision Making*, edited by Eduardo Salas and Gary Klein, 209-226. Mahwah: Erlbaum Associates.
- Sarter, Nadine B. and Heather M. Alexander. 2000. "Error Types and Related Error Detection Mechanisms in the Aviation Domain: An Analysis of Aviation Safety Reporting System Incident Reports." *The International Journal of Aviation Psychology* 10(2): 189-206.
- Speier, Cheri, Iris Vessey, and Joseph S. Valacich. 2003. "The Effects of Interruptions, Task Complexity, and Information Presentation on Computer-Supported Decision-Making Performance." *Decision Sciences* 34(4): 771-97.