

## CHAPTER 4

# BOILERS

The function of a boiler in the steam cycle is to convert water into steam. Reliability in operating naval boilers and associated equipment is important for the power plant to operate at maximum efficiency. The complex design of naval boilers requires a high degree of technical knowledge and skill on the part of the fireroom personnel responsible for boiler operations. All engineers should have some knowledge of the principles of combustion, how combustion occurs in a boiler, and the combustion requirements for operating a boiler more efficiently. You may want to review combustion in chapters 2 and 3 of this textbook.

This chapter describes boilers commonly used in propulsion plants of naval steam-driven surface ships. This information is general in nature and does not relate to any one class of ship. Chapter 221 of the *Naval Ships' Technical Manual* is the basic doctrine reference on boilers. For detailed information on the boilers in any particular ship, consult the manufacturer's technical manuals furnished with the boilers.

Upon completion of this chapter, you will have the knowledge to be able to identify and understand boiler terminology, the basic types of naval boilers and their operating principles, interpret gauges and indicators that aid in monitoring operating parameters of naval boilers, and understand boiler construction. You should be able to identify the major parts of a boiler and its functions. Also, you will learn about safety precautions that must be observed during boiler light-off.

### BOILER TERMINOLOGY

Before studying the types of boilers used in propulsion plants aboard Navy ships, you need to know the boiler terms and definitions used most frequently by shipboard personnel. In this section we have listed some of the terms used in this

chapter and by fireroom personnel on the job. It is not an all-inclusive list, but it will help form a basis for your understanding of the information presented on boilers.

- **Fireroom**— The fireroom is a compartment containing boilers and the operating station for firing the boilers.
- **Boiler room**— The boiler room is a compartment containing boilers but not containing the station for firing or operating the boiler.
- **Main machinery room**— The main machinery room is a compartment containing boilers and the station for firing or operating the boilers and main propulsion engines.
- **Boiler operating station**— The boiler operating station is a station from which a boiler or boilers are operated, applying particularly to the compartment from which the boilers are operated.
- **Steaming hours**— Steaming hours is the time during which the boilers have fires lighted until fires are secured.
- **Boiler full-power capacity**— Boiler full-power capacity is specified in the contract specifications of a ship. It is expressed as the number of pounds of steam generated per hour at the pressure and temperature required for all purposes to develop contract shaft hp of the ship divided by the number of boilers installed. Boiler full-power capacity is listed in the design data section of the manufacturer's technical manual for the boilers in each ship. It may be listed either as the capacity at full power or as the designed rate of actual evaporation per boiler at full power.

- **Boiler overload capacity**— Boiler overload capacity is specified in the design of the boiler. It is usually 120 percent of boiler full-power capacity, for either steaming rate or firing rate, as specified for the individual installation.
- **Superheater outlet pressure**— Superheater outlet pressure is the actual pressure at the superheater outlet at any given time.
- **Steam drum pressure**— Steam drum pressure is the actual pressure carried in the boiler steam drum at any given time.
- **Operating pressure**— Operating pressure is the constant pressure at which the boiler is being operated. This pressure may be carried at either the steam drum or the superheater outlet, depending on the design feature of the boiler. Operating pressure is specified in the manufacturer's technical manual.
- **Design pressure**— Design pressure is the maximum pressure specified by the boiler manufacturer as a criterion for boiler design. Design pressure is not the same as operating pressure. It is somewhat higher than operating pressure. Design pressure is given in the manufacturer's technical manual for the particular boiler.
- **Design temperature**— Design temperature is the maximum operating temperature at the superheater outlet at some specified rate of operation. For combatant ships the specified rate of operation is normally full-power capacity.
- **Operating temperature**— Operating temperature is the actual temperature at the superheater outlet. Operating temperature is the same as design temperature ONLY when the boiler is operating at rate specified in the definition of design temperature.
- **Boiler efficiency**— The efficiency of a boiler is the Btu's per pound of fuel absorbed by the water and steam divided by the Btu's per pound of fuel fired. In other words, boiler efficiency is output divided by input, or heat used divided by heat available. Boiler efficiency is expressed as a percent.
- **Superheater surface**— The superheater surface is that portion of the total heating surface where the steam is heated after leaving the boiler steam drum.
- **Economizer surface**— The economizer surface is that portion of the total heating surface where the feed water is heated before it enters the boiler steam drum.
- **Total heating surface**— The total heating surface area is the area of the generating, economizer, and superheater tube banks exposed in the boiler furnace. These tubes are that part of the heat transfer that exposes one side to combustion gases and the other side to the water or steam being heated.

## BOILER CLASSIFICATION

Boilers vary considerably in detail and design. Most boilers may be classified and described in terms of a few basic features or characteristics. Some knowledge of the methods of classification provides a useful basis for understanding the design and construction of the various types of naval boilers.

In the following paragraphs, we have considered the classification of naval boilers according to intended service, location of fire and water spaces, type of circulation, arrangement of steam and water spaces, number of furnaces, burner location, furnace pressure, type of superheaters, control of superheat, and operating pressure.

### INTENDED SERVICE

A good place to begin in classifying boilers is to consider their intended service. By this method of classification, naval boilers are divided into two classes, PROPULSION BOILERS and AUXILIARY BOILERS. Propulsion boilers are used to provide steam for ships' propulsion and for vital auxiliaries' services. Auxiliary boilers are installed in diesel-driven ships and in many steam-driven combatant ships. They supply the steam and hot water for galley, heating, and other hotel services and for other auxiliary requirements in port.

## LOCATION OF FIRE AND WATER SPACES

One of the basic classifications of boilers is according to the relative location of the fire and water spaces. By this method of classification, boilers are divided into two classes, FIRE-TUBE BOILERS and WATER-TUBE BOILERS. In the fire-tube boilers, the gases of combustion flow through the tubes and thereby heat the water that surrounds the tubes. In water-tube boilers, the water flows through the tubes and is heated by the gases of combustion that fill the furnace and heat the outside metal surfaces of the tubes.

All propulsion boilers used in naval ships are of the water-tube type. Auxiliary boilers may be either fire-tube or water-tube boilers.

## TYPE OF CIRCULATION

Water-tube boilers are further classified according to the method of water circulation. Water-tube boilers may be classified as NATURAL CIRCULATION BOILERS or FORCED CIRCULATION BOILERS.

In natural circulation boilers, the circulation of water depends on the difference between the density of an ascending mixture of hot water and steam and a descending body of relatively cool and steam-free water. The difference in density occurs because the water expands as it is heated, and thus, becomes less dense. Another way to describe natural circulation is to say that it is caused by convection currents which result from the uneven heating of the water contained in the boiler.

Natural circulation may be either free or accelerated. In a boiler with free natural circulation, the generating tubes are installed almost horizontally, with only a slight incline toward the vertical. When the generating tubes are installed at a much greater angle of inclination, the rate of water circulation is definitely increased. Therefore, boilers in which the tubes slope quite steeply from steam drum to water drum are said to have natural circulation of the accelerated type.

Most naval boilers are designed for accelerated natural circulation. In such boilers, large tubes (3 inches or more in diameter) are installed between the steam drum and the water drum. These large tubes, or DOWNCOMERS, are located outside the furnace and away from the heat of combustion. They serve as pathways for the downward flow of relatively cool water. When

enough downcomers are installed, all small tubes can be generating tubes, carrying steam and water upward, and all downward flow can be carried by downcomers. The size and number of downcomers installed varies from one type of boiler to another, but downcomers are installed in all naval boilers.

Forced circulation boilers are, as their name implies, quite different in design from the boilers that use natural circulation. Forced circulation boilers depend upon pumps, rather than upon natural differences in density, for the circulation of water within the boiler. Because forced circulation boilers are not limited by the requirements that hot water and steam must be allowed to flow upward while the cooler water flows downward, a great variety of arrangements may be found in forced circulation boilers.

## ARRANGEMENT OF STEAM AND WATER SPACES

Natural circulation water-tube boilers are classified as DRUM-TYPE BOILERS or HEADER-TYPE BOILERS, depending on the arrangement of the steam and water spaces. Drum-type boilers have one or more water drums (and usually one or more water headers as well). Header-type boilers have no water drum; instead, the tubes enter many headers which serve the same purpose as water drums.

What is a header, and what is the difference between a header and a drum? The term *header* is commonly used in engineering to describe any tube, chamber, drum, or similar piece to which tubes or pipes are connected in such a way as to permit the flow of fluid from one tube (or group of tubes) to another. Essentially, a header is a type of manifold or collection point. As far as boilers are concerned, the only distinction between a drum and a header is size. Drums may be entered by a person while headers cannot. Both serve basically the same purpose.

Drum-type boilers are further classified according to the overall shape formed by the steam and water spaces—that is, by the tubes. For example, double-furnace boilers are often called M-type boilers because the arrangement of the tubes is roughly M-shaped. Single-furnace boilers are often called D-type boilers because the tubes form a shape that looks like the letter *D*.

## NUMBER OF FURNACES

All boilers commonly used in the propulsion plants of naval ships may be classified as either SINGLE-FURNACE BOILERS or DOUBLE-FURNACE BOILERS. The D-type boiler is a single-furnace boiler; the M-type boiler is a double-furnace (divided-furnace) boiler.

## BURNER LOCATION

Naval boilers are also classified on the basis of where their burners are located. Most burners in naval propulsion plants are located at the front of the boiler. These are called FRONT-FIRED BOILERS. Other ships, such as the AO-177 and LKA-113 class ships, have their burners on the top of the boilers. These are called TOP-FIRED BOILERS.

## FURNACE PRESSURE

Another convenient boiler classification is based on the air pressure used in the furnace. Most boilers in use in naval propulsion plants operate with a slight air pressure (seldom over 5 psig) in the boiler furnace. This slight pressure is not enough to justify calling these boilers pressurized-furnace boilers. However, some boilers installed on naval ships are truly pressurized-furnace boilers. They are called PRESSURE-FIRED or SUPERCHARGED BOILERS. These furnaces are maintained under a positive air pressure of about 65 psia (about 50 psig) when operated at full power. The air pressure in these boiler furnaces is maintained by special air compressors called superchargers.

## TYPE OF SUPERHEATERS

On almost all boilers used in the propulsion plants of naval ships, the superheater tubes are protected from radiant heat by water screen tubes. The water screen tubes absorb the intense radiant heat of the furnace, and the superheater tubes are heated by convection currents rather than by direct radiation. These superheaters are called CONVECTION-TYPE SUPERHEATERS.

In a few older ships, the superheater tubes are not screened by water screen tubes but are exposed directly to the radiant heat of the furnace. Superheaters of this design are called RADIANT-TYPE SUPERHEATERS.

## CONTROL OF SUPERHEAT

A boiler that provides some means of controlling the degree of superheat independently of the rate of steam generation is said to have CONTROLLED SUPERHEAT. A boiler in which such separate control is not possible is said to have UNCONTROLLED SUPERHEAT.

Normally, the term *superheat control boiler* is used to identify a double-furnace boiler. The term *uncontrolled superheat boiler* is used to identify a single-furnace boiler.

## OPERATING PRESSURE

For some purposes, it is convenient to classify boilers according to operating pressure. Most classification of this type are approximate rather than exact. Header-type boilers and some older drum-type boilers are often called 400-PSI BOILERS even though their operating pressures range from about 435 psi to 700 psi.

The term *high-pressure boiler* is at present used rather loosely to identify any boiler that operates at a substantially higher pressure than the so-called 600-PSI BOILERS. In general, we will consider any boiler that operates at 751 psi or above as a high-pressure boiler. Many boilers in naval ships operate at about 1200 psi. These boilers are referred to as 1200-PSI BOILERS.

As you can see, classifying boilers by operating pressure is not very precise since actual operating pressure may vary widely within any one group. Also, any classification based on operating pressure may easily become obsolete. What is called a high-pressure boiler today may well be called a low-pressure boiler tomorrow.

## BOILER COMPONENTS

Boilers used onboard naval ships have essentially the same components: steam and water drums, generating and circulating tubes, superheaters, economizers, and accessories and fittings for controlling steam pressure and temperature and other aspects of boiler control and operation.

Figure 4-1 shows a cutaway view of a D-type boiler. You should refer to this figure as a guide to the arrangement of the boiler components. As we discuss the boiler and its components, imagine that you are assembling a similar boiler. As you

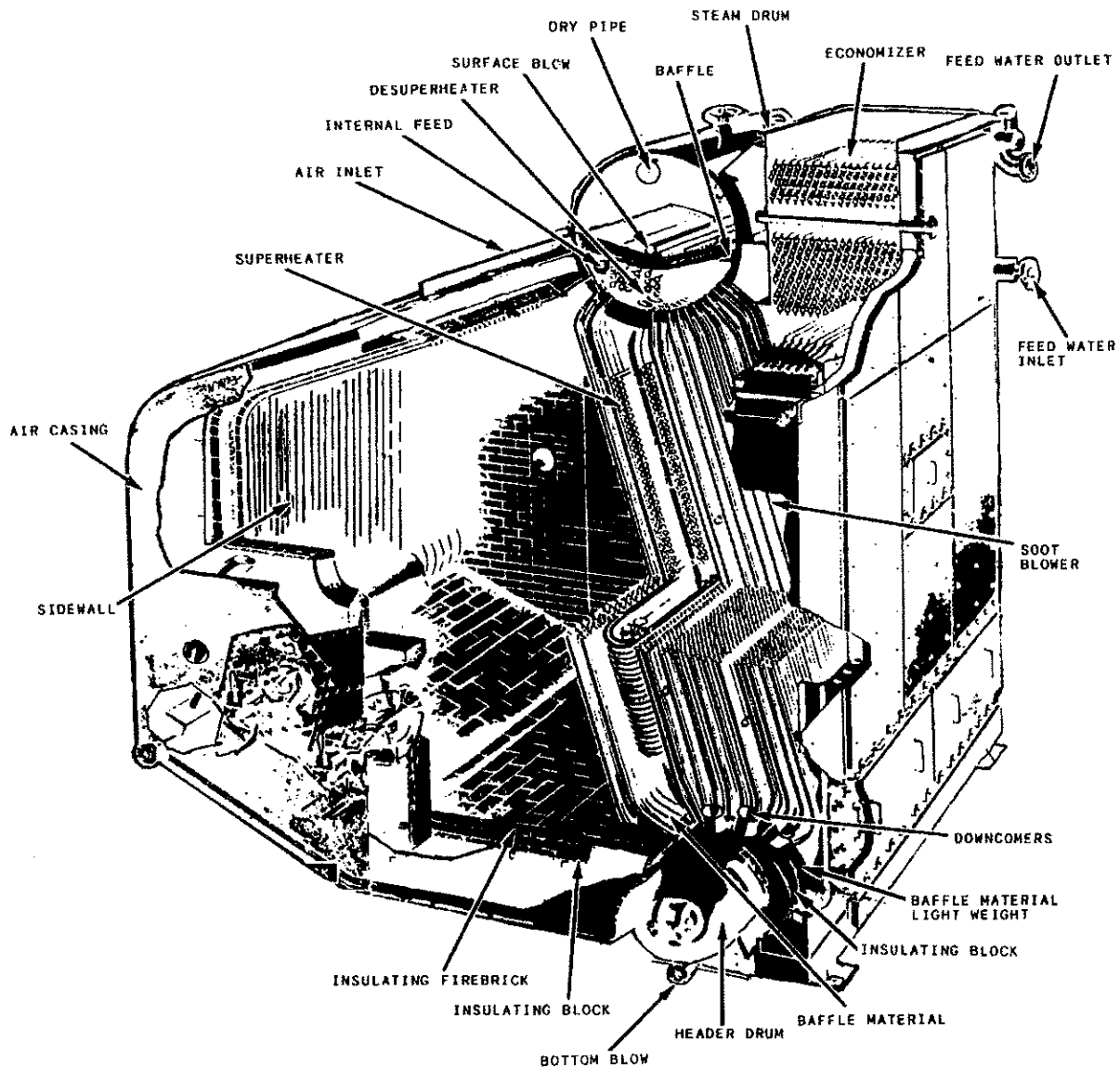

Figure 4-1.—Cutaway view of a D-type boiler.

add each part to your boiler, follow the line drawings introduced in the following paragraphs that describe the position of each component.

### STEAM DRUM

The steam drum is a cylinder located at the top of the boiler. It runs lengthwise (fig. 4-1) from the front to the back of the boiler. The steam drum provides a space for the saturated steam generated in the tubes and for the separation of moisture from the steam. (Remember, saturated

steam is steam that has not been heated above the temperature of the water from which it was generated). The steam drum also serves as a storage space for boiler water, which is distributed from the steam drum to the downcomer tubes. During normal operation, the steam drum is kept about half full of water. The steam drum either contains or is connected to many of the important controls and fittings required for the operation of the boiler.

At the bottom right side of the boiler you will find the water drum, and on the bottom left side

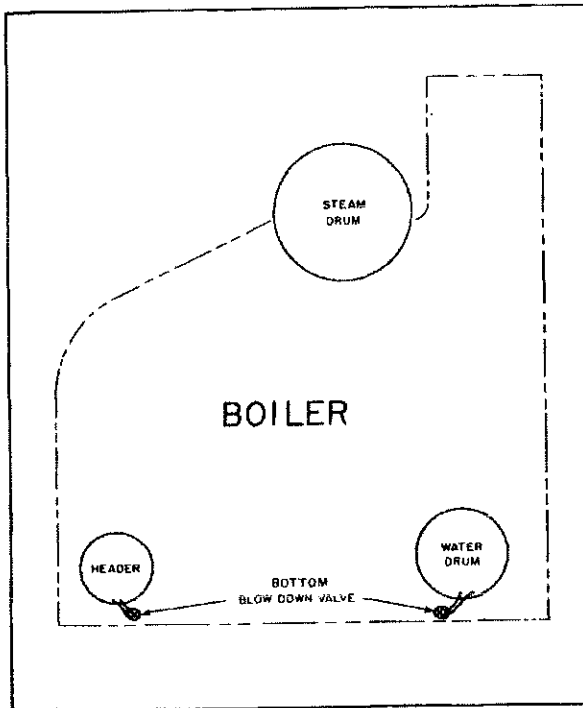

Figure 4-2.—Steam drum, water drum, and header.

is the sidewall header (fig. 4-2). Notice the header is smaller than the water drum. Most boilers have more than one header. They are identified by their location. For example, a header at the back of the boiler is called a rear wall header. A header on a screen wall is called a screen wall header.

### WATER DRUM

The water drum is larger than the header, but both are smaller than the steam drum. The water drum equalizes the distribution of water to the generating tubes. Both the water drum and the header collect the deposits of loose scale and other solid matter present in the boiler water. Both the drum and the header have bottom blowdown valves. When these valves are opened, some of the water is forced out of the drum or header and carries any loose particles with it. **DO NOT OPEN THE BOTTOM BLOWDOWN VALVES ON A STEAMING BOILER.** Opening these valves will interrupt the circulation of the steam cycle.

### DOWNCOMER TUBES

At each end of the steam drum are a number of large tubes (fig. 4-3) that lead to the water drum

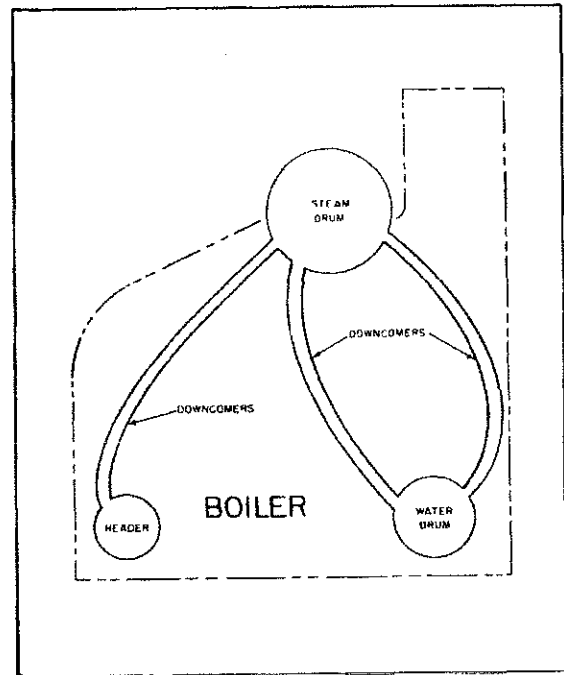

Figure 4-3.—Downcomer tubes.

and sidewall header. These tubes are the downcomers through which water flows downward from the steam drum to the water drum and the header. The downcomers range in diameter from 3 to 8 inches.

### GENERATING TUBES

Many tubes link the steam drum to the water drum and to the header. The tubes that lead from the water drum to the steam drum are the generating tubes (fig. 4-4). They are arranged in the furnace so the gases and the heat of combustion can flow around them. The large arrows in figure 4-4 show the direction of flow of the combustion gases.

The generating tubes are made of steel that is strong enough to withstand the high pressures and temperatures within the boiler. In most boilers these tubes are usually 1 to 2 inches in diameter, but some may be 3 inches. These small tubes present a large surface area to absorb furnace heat. A 2-inch tube has twice the surface area of a 1-inch tube but four times the volume. A 3-inch tube has three

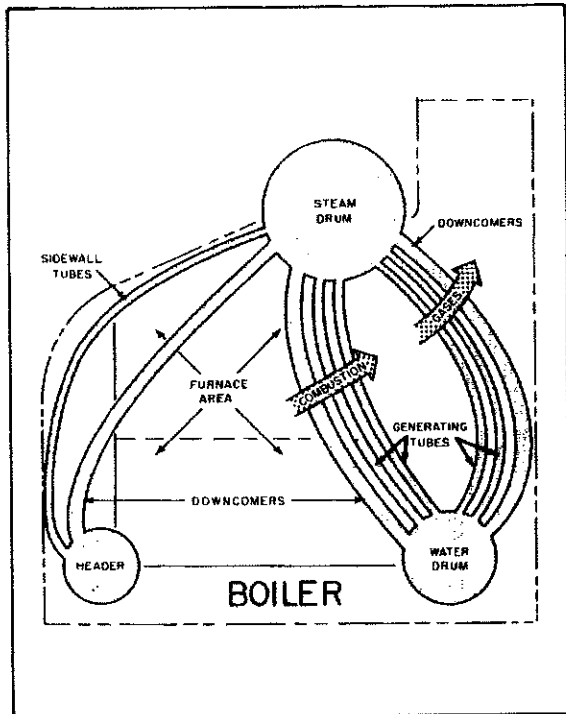

Figure 4-4.—Generating tubes and furnace area.

times the surface area of a 1-inch tube but nine times the volume. The smaller the diameter of the tube, the higher is the ratio of absorption surface to the volume of water.

Normally, only one row of tubes leads from the steam drum to the sidewall header. These are the sidewall (water wall) tubes. Their function is to cool and protect the side wall of the furnace.

So far, we have assembled the drums, header, downcomers, and generating tubes. Before going any further with the assembly, let us trace the path of the water through the boiler.

As the water is heated, it becomes less dense, and steam is formed in the tubes. The water in the steam drum is much cooler than the steam and has greater density. As the hotter water and steam rise through the generating tubes, the cooler more dense water drops through the downcomers to the water drum and headers. The arrows in figure 4-5 show the circulation path of the water as it leaves the steam drum and returns to the steam drum as steam. Notice that the caption under figure 4-5 states that it is an accelerated type. This is indicated by the inclination of the tubes. The tubes

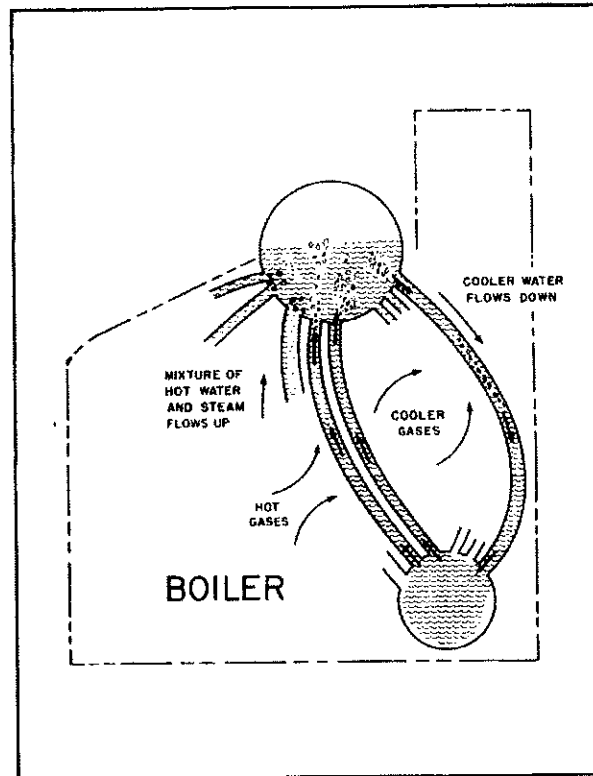

Figure 4-5.—Natural circulation (accelerated type).

shown are almost vertical. The greater the incline, the greater the acceleration.

So far, we have learned how the steam is formed in a boiler. Next, let's find out what happens to the steam once it returns to the steam drum from the generating tubes.

## INTERNAL FITTINGS

Components of the steam drum area are known as INTERNAL FITTINGS. The internal fittings we will discuss are the feedwater distribution, the chemical injection, and the steam and water separator. This equipment is used to direct the flow of steam and water within the steam drum and the desuperheaters, which are located either in the steam drum or the water drum. We will also discuss the economizer in this section. This component is not considered an internal fitting, but its role is important to the function of the steam drum.

The design and arrangement of a steam drum's internal fittings will vary somewhat from

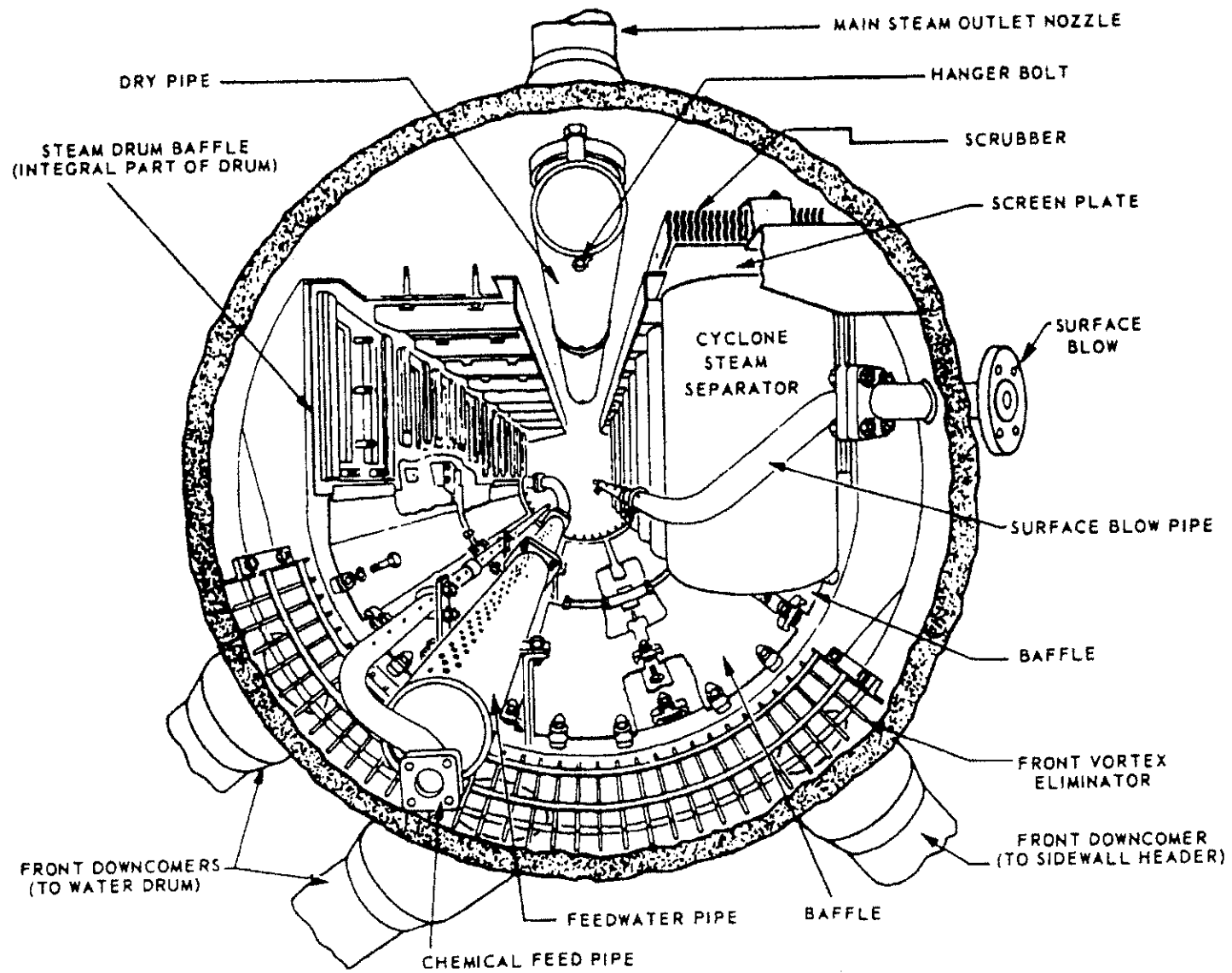

Figure 4-6.—Arrangement of internal fittings in a single-furnace boiler.



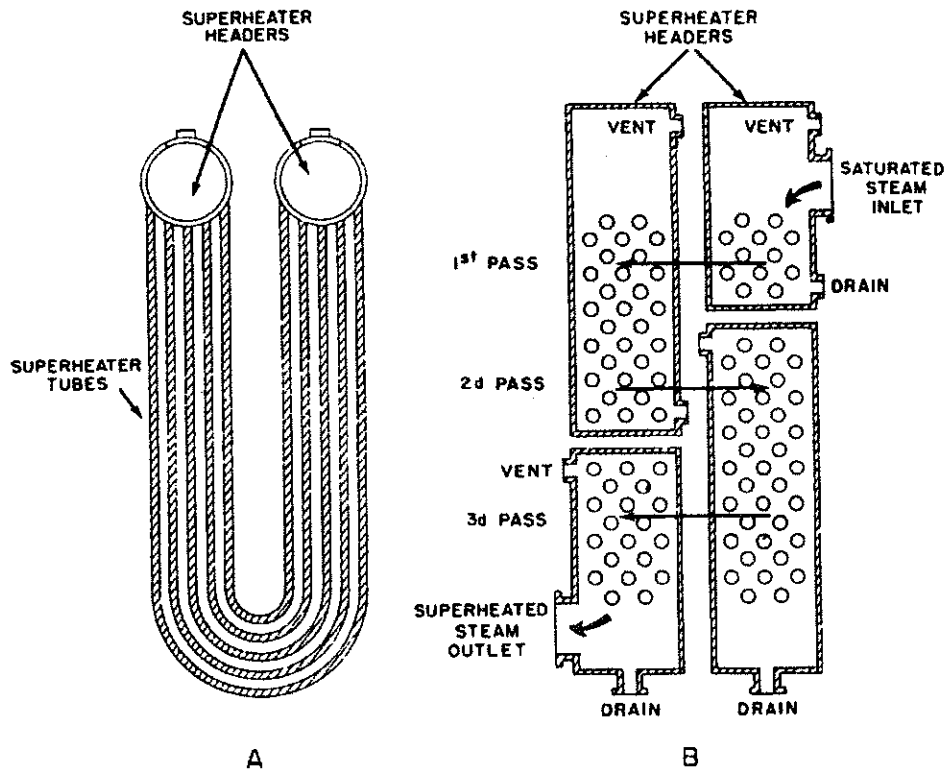

Figure 4-7.—Diagram of a superheater.

one type of boiler to another and from one boiler manufacturer to another. Figure 4-6 shows the arrangement of the steam drum internal fittings in a single-furnace boiler.

- The feedwater pipe receives feedwater from the economizer and distributes it throughout the length of the steam drum.

- The chemical feed pipe is used to inject chemicals into the boiler to maintain the proper pH and phosphate balance in the boiler water.

- The surface blow pipe is used to remove suspended solid matter that floats on top of the water and to lower the steam drum water level, when necessary. The surface blow pipe is also used to blow water out to lower the chemical level in the boiler when it becomes too high.

- The dry pipe is used to direct the steam to the steam drum outlet nozzle after it leaves the scrubbers.

- The vortex eliminators are used to reduce the swirling motion of the water as it enters the downcomers.

- The baffle plates are used to direct the steam to the steam separators.

- The cyclone steam separators remove moisture from the steam. This is accomplished by the steam spinning or changing direction. The water drains back into the steam drum while the steam continues upward through a screen and scrubber that removes still more moisture.

After the steam leaves the scrubbers, it goes to the dry pipe (fig. 4-6). From there it leaves the steam drum through the steam drum outlet. Figure 4-7, view A, shows the steam going to the inlet header of the superheater and passing through the U-shaped tubes of the superheater to the next header (fig. 4-7, view B). This header is called the first pass or intermediate header. Steam may pass through the U-shaped tubes several times before passing to the outlet header. Each time the steam goes from one header to the next header it is called a pass. The number of passes the steam makes in a superheater varies with different boilers and the degree of superheat that is required for a particular ship.

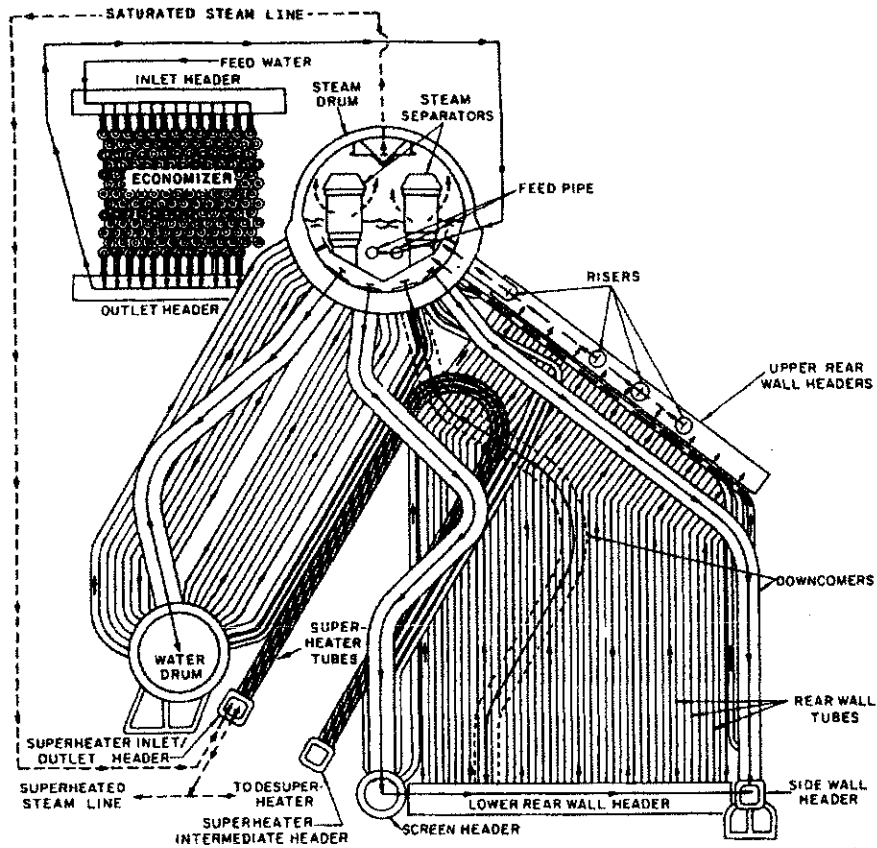

Figure 4-8.—Vertical superheater.

As the steam passes through the superheater tubes, it is heated by the hot gases from combustion, which flow around the tubes.

In some boilers, the superheater headers are installed parallel with the water drum; and the tubes are installed vertically (fig. 4-8). These are called vertical superheaters.

Another boiler internal fitting is the desuperheater. It may be located either in the steam drum or in the water drum. All the steam generated in a single-furnace boiler is led through the superheater. However, since some auxiliary machinery is not designed for superheated steam, the steam must be cooled down. This is done with a desuperheater. The desuperheater gets steam from the superheater outlet, as shown in figure 4-9. The desuperheater is submerged in water either in the steam drum or in the water drum. As the steam passes through the desuperheater, it is cooled for use in the auxiliary steam systems.

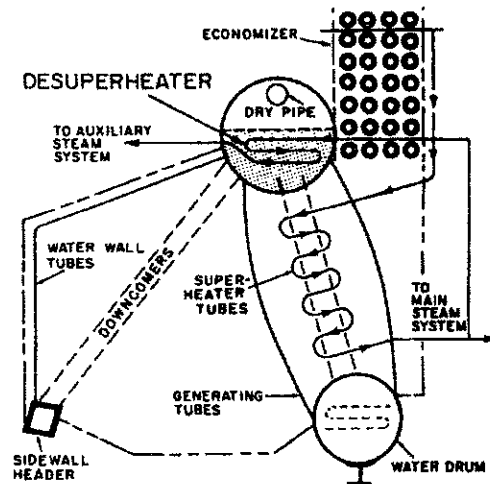

Figure 4-9.—Relative position of desuperheater tubes.

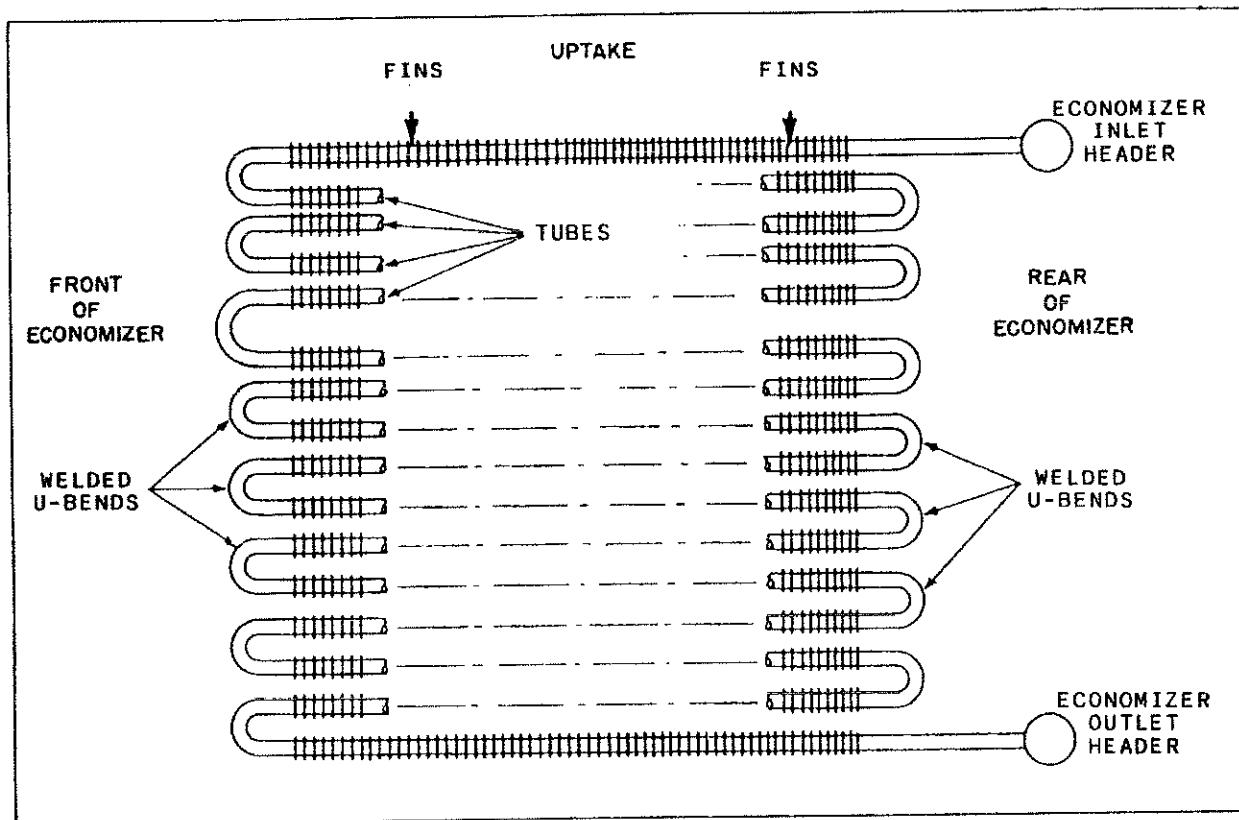

Figure 4-10.—Side view of an economizer.

It is important that all internal fittings are properly installed and in good working condition. If excessive moisture is carried over into the superheater, serious damage will result in the superheater tubes, piping, and turbines.

The economizer (fig. 4-10) is an arrangement of tubes installed in the uptake space from the furnace. The economizer tubes have metal projections from the outer tube surfaces. These projections are called by various names, including FINS, STUDS, RINGS, or GILL RINGS. They are made of aluminum, steel, or other metals, in a variety of shapes. These projections serve to extend the heat transfer surface of the tubes on which they are installed.

Before entering the steam drum, all feedwater flows through the economizer tubes. The economizer tubes are heated by the rising gases of combustion. The feedwater is warmed or preheated by the combustion gases that would otherwise be wasted as they pass up the stack.

In figure 4-1 you can see that the economizer is positioned on top of the boiler. There it acts as a preheater.

So far, you have learned how the water gets to the boiler and what happens while it's there. Next, let's find out how the water is heated, where the heat comes from, and what boiler components are necessary for generating this heat.

## FURNACE

The furnace, or firebox, is the large, room-like space where air and fuel are mixed for the combustion (fire) that heats the water in the drums, tubes, and headers.

The furnace is more or less a rectangular steel casing that is lined on the floor and walls with refractory (heat-resisting) material. Refractory materials used in naval boilers include firebrick, insulating brick, insulating block, and air-setting

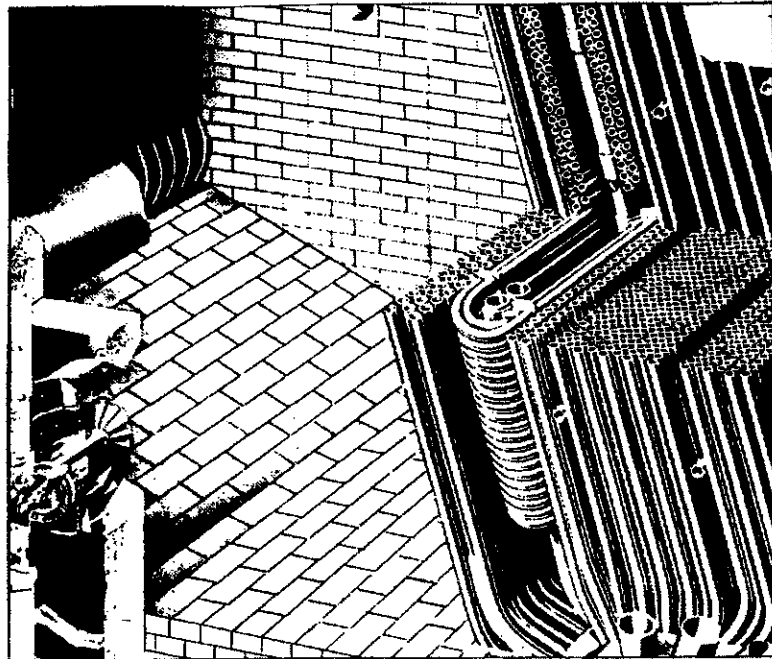

Figure 4-11.—Refractory-lined furnace.

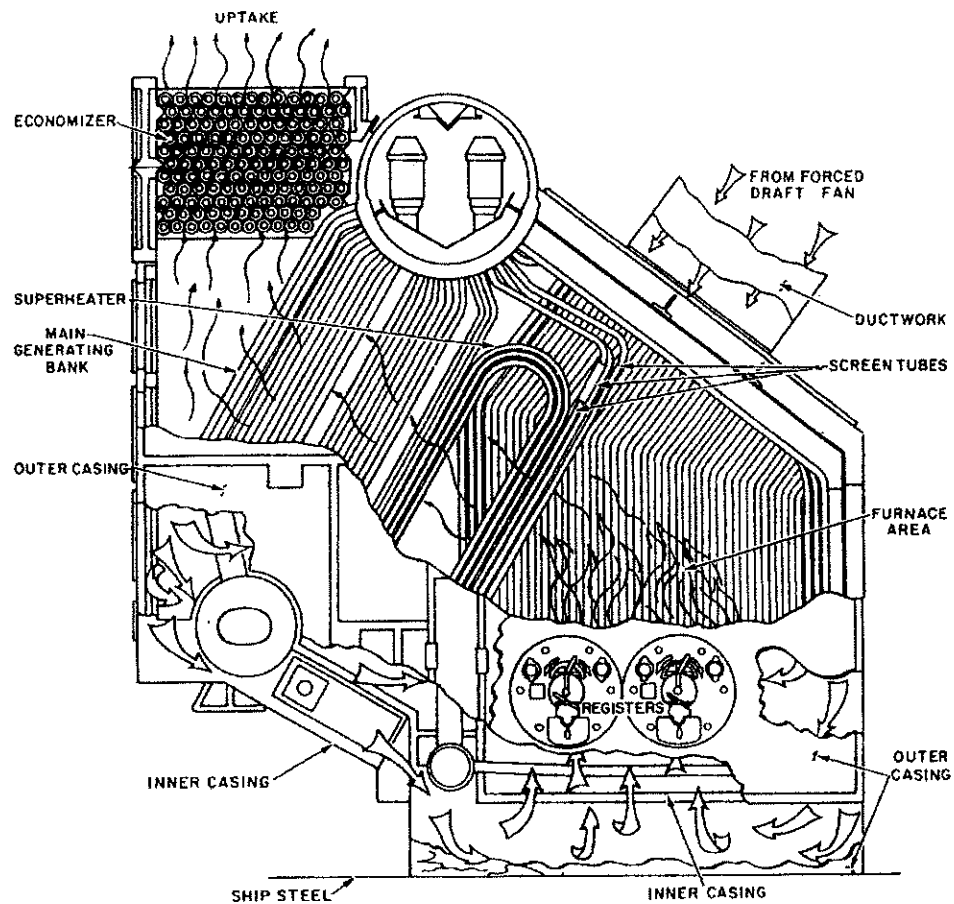

Figure 4-12.—Combustion air and gas flow.

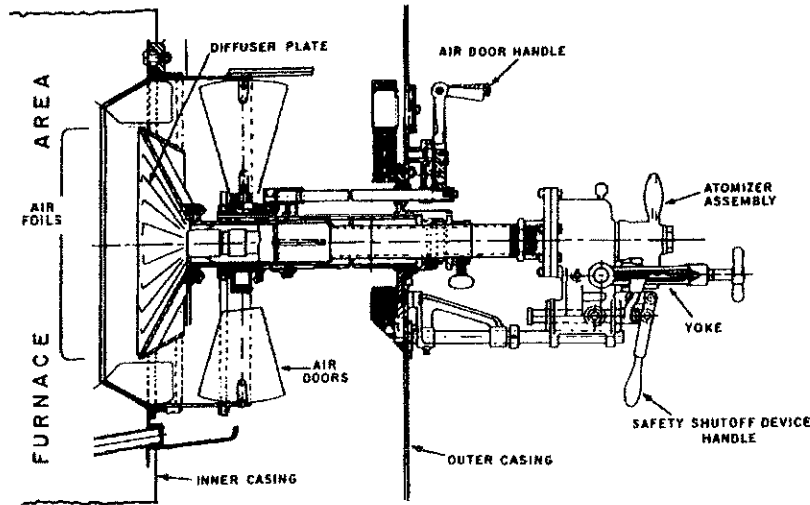

Figure 4-13.—Fuel-oil burner assembly.

mortar. Figure 4-11 shows a refractory-lined furnace.

The refractory lining protects the furnace steel casing and prevents the loss of heat from the furnace. The lining also retains heat for a relatively long time and helps to maintain the high furnace temperatures that are needed for complete fuel combustion.

### Combustion Air

Air is forced into the furnace by a forced draft blower. The forced draft blower is a large volume fan that can be powered by an electric motor or a steam turbine. The forced draft blower blows air into the outer casing of the boiler (fig. 4-12). The air then travels between the inner casing and outer casing to the boiler front where it is forced into the furnace through the air registers. The air registers are part of the fuel-oil burner assembly that consists of four main parts: air doors, a diffuser, air foils, and the atomizer assembly. Figure 4-13 shows a side view of a fuel-oil burner assembly.

**AIR REGISTERS.**— The air entering the furnace through the air registers mixes with a fine fuel-oil spray through the atomizer. Figure 4-13 shows the arrangement of an air register in a fuel-oil burner assembly. The air doors are used to open or close the register, as necessary. They are usually kept either fully opened or fully closed. When the air doors are open, air rushes in and is given a whirling motion by the diffuser plate. The diffuser plate causes the air to mix evenly with the atomized oil in such a way that the flame will not blow away from the atomizer (atomizers are

discussed in the next paragraph). The air foils guide the major quantity of air so it mixes with the larger particles of fuel oil spray beyond the diffuser.

**ATOMIZERS.**— Atomizers (devices for producing a fine spray) break up the fuel oil into very fine particles. In the following paragraphs we will briefly discuss the three types of atomizers. These three types are the return-flow atomizer, the steam-assist atomizer, and the vented-plunger atomizer.

**Return-Flow Atomizer.**— The return-flow atomizer provides a constant supply of fuel-oil pressure. Any fuel oil not needed to meet steam demand is returned to the fuel-oil service tank. This is accomplished by the return control valve installed in the piping between the boiler front and the service tank. As the return control valve is closed, more fuel oil is forced through the sprayer plate into the furnace. The return-flow atomizer is shown in figure 4-14.

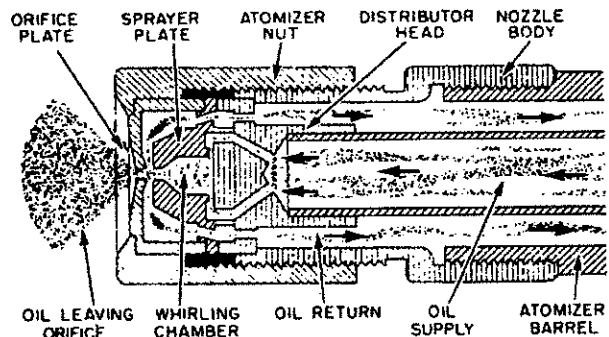

Figure 4-14.—Return-flow atomizer.

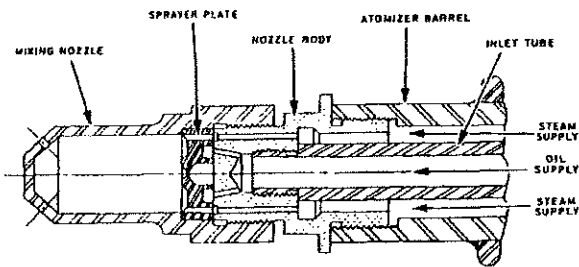

Figure 4-15.—TODD LVS atomizer.

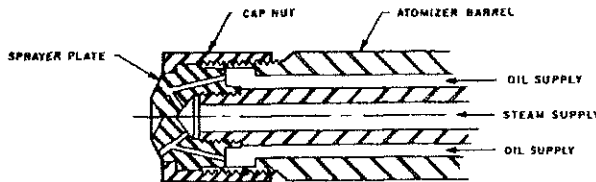

Figure 4-16.—Y-Jet steam atomizer.

**Steam-Assist Atomizer.**— The steam-assist atomizer employs 150 psi of steam mixed with the fuel oil to help atomize the fuel oil. The two most common steam-assist atomizers in use by the Navy are the TODD LVS (fig. 4-15) and the Y-Jet (fig. 4-16). All steam-assist atomizers must have low-pressure air hookup for use as a substitute when suitable auxiliary steam is not available.

**Vented-Plunger Atomizer.**— The vented-plunger atomizer shown in figure 4-17 is unique in that it is the only atomizer in use in the Navy that has moving parts. The fuel oil flows down the atomizer barrel and around the atomizer cartridge. The pressure in the barrel forces the fuel oil into the cartridge through the holes drilled in the cartridge. As the fuel is forced into the cartridge, it begins to spin. This motion forces the fuel out through the orifice in a fine mist. Increasing fuel-oil pressure in the atomizer barrel and cartridge will cause the piston to overcome the spring pressure. The piston is then forced back, uncovering more holes and allowing fuel to be atomized and forced into the furnace. As pressure decreases, the opposite occurs. The spring tension recalls the piston, covering the holes and allowing less fuel oil to be atomized.

#### Fire

In most boilers, a torch is used to light fires. However, some boilers may have electric igniters.

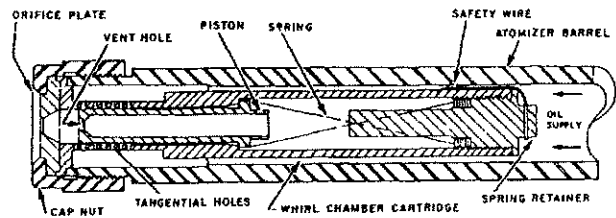

Figure 4-17.—Vented-plunger atomizer.

We will describe the more common method—lighting fires with a torch.

Boiler light off is always a two-person operation. One person is needed to handle the torch, the air register, and the furnace, and the other to open the fuel-oil root valve. If fires do not light in 2 or 3 seconds, you must secure the fuel oil and investigate the reason for the failure to light. The boiler furnace must be inspected and repurged before the next attempt to light.

The basic light-off procedure involves the following steps:

1. Ensure that all fuel-oil manifold and atomizer/safety shut-off valves are shut.
2. Insert a clean atomizer with a lighting-off sprayer plate into the No. 1 burner.
3. Adjust the combustion air and fuel-oil pressures for lighting the fires.
4. Ignite the lighting-off torch.
5. Insert the lighted torch into the lighting-off port and close the port cover; visually check to ensure that the torch remains lighted. However, you should never insert a torch into a furnace until you are sure that no fuel is on the furnace deck and that the boiler has been purged of all combustible gases.
6. Open the No. 1 burner fuel-oil atomizer/safety shut-off valve(s).
7. Open the No. 1 burner fuel-oil supply manifold valve one-half turn.
8. Observe the furnace through the No. 1 burner observation port to ensure that the ignition is successful.
9. Adjust the flame with the burner air register handle.
10. Open the No. 1 burner fuel-oil supply manifold to the fully open position.
11. Withdraw and extinguish the torch.

For specific lighting-off instructions, always refer to your ship's EOSS.

The following are a few simple suggestions to make your job easier and safer:

- Do not operate any valves or start equipment until you have permission from the EOOW or EDO, and always refer to the EOSS.
- Always clean up any spills or debris.
- Report to your supervisor any condition that you think may be abnormal.
- Do not be afraid to ask questions!

### AUXILIARY BOILER

An auxiliary boiler is a small boiler that supplies steam for distilling plants, space heating, oil heating, water heating, galley, and laundry. These boilers have all the auxiliaries, accessories, and controls to form a unit assembly. They are arranged to operate as complete self-contained, steam-generating plants. For further information

on auxiliary boilers, refer to *Naval Ships' Technical Manual*, S9086-GY-STM-000, chapter 221, section 5.

### WASTE-HEAT BOILERS

On some classes of ships, you may find waste-heat boilers. Waste-heat boilers are used by the *Spruance* class and *Ticonderoga* class CGs. These boilers supply the steam for ship's services by using the hot exhaust gases from the gas turbine generator sets (GTGSs). For further information on waste-heat boilers, refer to *GSM 3 & 2*, NAVEDTRA 10548-2, chapter 6.

### SUMMARY

In this chapter we have discussed boiler terminology, construction, types, components, and function. To help you understand this information, go down to the fireroom on your ship and ask a BT to show and explain to you the things you have just read about. This should help your retention of the information you have studied and perhaps provide you with additional knowledge on boilers.